

# Product Guide

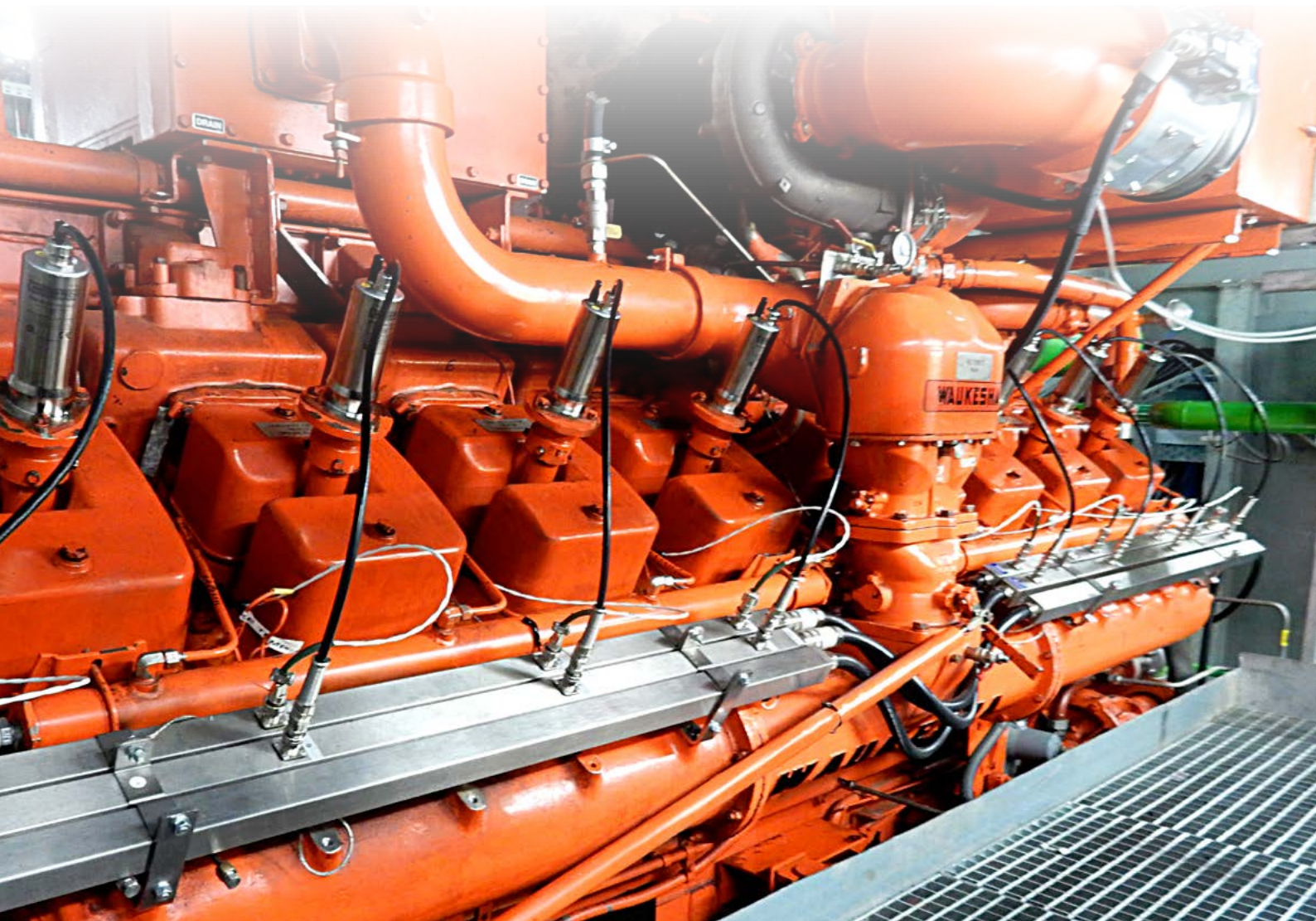

**GAS ENGINE TECHNOLOGY**

reliable • efficient • worldwide

## QR Codes® for Additional Product Information

Many pages in this catalogue are provided with a QR code® which allows easy access to further product information such as brochures, specification tables or data sheets. Scan the respective QR code with your mobile phone and get to the quickest way to find out more about MOTORTECH products.

*(QR code® scanners are available for download in the App-Store/Play-Store)*





### All Products for your Application!

For detailed information about equipment for your engine type please take a look at our Application Guides.



Scan QR code®  
to download



# Table of Contents

## 6 ■ Ignition Controllers & Harnesses

- 6 Characteristics MIC Series
- 7 Technical Data
- 8 MOST –  
MOTORTECH Output Stage Technology
- 9 MICT –  
MOTORTECH Integrated Configuration Tool
- 10 System Overview MIC3+/MIC4/MIC5
- 12 MIC3+ Series
- 14 MIC3+CATDI – Retrofit for  
CATERPILLAR® G3300 & G3400 Gas Engines
- 14 MIC3+CEC – Retrofit for  
WAUKESHA® ATGL, VGF & VHP Gas Engines
- 15 MIC4 Series
- 18 MIC4-ZS Kits
- 19 MIC5 Series
- 21 MIC6 Series
- 26 PowerView3 – Ignition Control Visualization
- 28 MOT601 Single Cylinder Ignition System
- 30 Harnesses for Competition  
Ignition Control Systems

## 32 ■ Ignition Coils

- 32 New MOTORTECH Style
- 33 MOTORTECH Style
- 33 ALTRONIC® Style
- 34 Ignition Coils for CATERPILLAR® Gas Engines
- 36 Ignition Coil for WÄRTSILÄ® Gas Engines
- 36 New Ignition Coil Conversion Kits for CUMMINS®  
QSK60G and QSV91G Gas Engines
- 37 Ignition Coil Conversion Kits  
for CUMMINS® & WÄRTSILÄ® Gas Engines
- 38 Ignition Coil Extensions
- 40 Accessories for Unshielded Ignition Coils
- 42 Flange Ignition Coils
- 46 Hardware Kit for WAUKESHA® VHP-GL Engines
- 48 Externally Mounted Ignition Coils
- 50 Integral Ignition Coils

## 54 ■ Pickups & Trigger Drives

- 54 Pickups
- 56 Special Application Pickups
- 57 Pickup Leads
- 58 Trigger Discs
- 60 Reluctor Pins & Trigger Magnets
- 60 Trigger Drives
- 62 Trigger Devices
- 64 Tools & Accessories

## 66 ■ Primary Leads

- 66 Primary Leads – New Flex Style
- 69 Special Application Primary Leads
- 70 Primary Leads for AlphaRail Wiring Rails

## 72 ■ Spark Plug Leads & Extensions

- 72 Spark Plug Leads – Patented PolyMot™ Style
- 80 Spark Plug Leads for CATERPILLAR® Gas Engines
- 82 Spark Plug Leads for WAUKESHA® Gas Engines
- 84 Spark Plug Leads for common Applications  
(Non PolyMot™ Style)
- 85 Unshielded Safety Leads  
for Shielded Spark Plugs
- 88 Accessories for Unshielded Spark Plug Leads
- 92 MOT-Blues Shielded Spark Plug Leads
- 95 Conventional Shielded Spark Plug Leads
- 97 Terminal Repair Kits
- 98 Spark Plug Extensions –  
Patented PolyMot™ Style
- 100 Ignition Coil Extensions
- 101 Ignition Coil Extension Overhaul Kits
- 103 Extensions for Shielded Spark Plugs
- 103 Extensions for Integral Ignition Coils

## 104 ■ Ignition Wiring Rails & Hardware

- 104 Wiring Rail System for Ignition Control
- 110 Ignition Wiring Rail Upgrade Kits
- 112 Ignition Wiring Rail Kits for  
CATERPILLAR® Gas Engines
- 115 Ignition Kits for Unshielded Applications



# Table of Contents

## 120 ■ Ignition Tools & Test Equipment

- 120 SparkView High Voltage Indicator
- 121 SparkScan1 High Voltage Clamp
- 121 Digital Scope Meter
- 122 ICT – Ignition Coil Tester
- 123 IPS – Ignition Pickup Simulator
- 124 Test Adaptor for MOTORTECH Ignition Controllers
- 125 ScopeLite Timing Light
- 126 Tools & Workshop Equipment
- 127 Brush Kit for Termination Wells

## 130 ■ Spark Plugs & Accessories

- 130 DENSO® Spark Plugs
- 136 MOTORTECH High Performance Spark Plugs
- 138 MOTORTECH Bridge Spark Plugs
- 139 MOTORTECH Pre-Chamber Spark Plugs
- 140 ICP – Spark Plugs with Dual Thread
- 142 XT-Plugs – Extended Barrel Spark Plugs
- 144 XTL-Plugs – Extended Barrel Spark Plugs
- 148 Spark Plug Tools
- 154 Spark Plug Accessories

## 156 ■ Gas Engine Control Systems

- 156 DetCon – Detonation Control System
- 161 PowerView3 Detonation Control Visualization
- 162 AlphaRail Wiring Rail System for Detonation Control
- 166 TempScan20 Temperature Module
- 167 PowerView3 Temperature Module Visualization
- 168 AlphaRail Wiring Rail System for Temperature Control
- 174 Throttle Bodies
- 178 Throttle Bodies with Integrated Stepper Motor
- 182 ITB – Integrated Throttle Bodies & Throttle Body Drive Kits for MAN® Gas Engines
- 184 Throttle Bodies for MAN® Gas Engines
- 186 Throttle Bodies for WAUKESHA® Gas Engines
- 190 ALL-IN-ONE Generator & CHP Control Systems
- 196 Actuator Replacement Kit for WAUKESHA® VHP Series Engines

## 198 ■ Sensor Systems

- 198 Thermocouple Rails for WAUKESHA® 12 Cylinder VHP Engines
- 200 Thermocouples
- 202 Oxygen Sensors
- 204 MAT – Manifold Air Temperature Sensors
- 204 MAP – Manifold Absolute Pressure Sensor
- 205 Sensor Harnesses for MAN® Gas Engines
- 207 Harnesses for WOODWARD® L-/ProAct Series

## 208 ■ Air/Fuel Ratio Control Systems

- 208 VariFuel Air/Gas Mixer Series
- 220 VariFuel2-TEM Air/Gas Mixer for MWM® Gas Engines
- 222 VariStep3 Stepper Motor Driver
- 223 EmCon5 Lean-Burn Emission Controller

## 226 ■ Exhaust Gas Aftertreatment

- 226 VariSCR NO<sub>x</sub> Emission Controller
- 228 Catalysts

## 232 ■ Gas Engine Accessories

- 232 Valve Cover Conversion Kit with Flange Safety Device for Spark Plug Leads
- 234 OLC – Oil Level Controller
- 238 Coolant Filtration
- 240 Lube Oil Filtration
- 242 Ultrasonic Cleaning Equipment

## 244 ■ Technical Support & Service

- 245 Demo Cases
- 246 Technical Training at MOTORTECH
- 246 Service Team
- 247 MOTORTECH Flat Rate Repair and Overhaul Service for Ignition Controllers and VariFuel2 Air/Gas Mixers

## 248 ■ A-Z

# Ignition Controllers & Harnesses

## Characteristics MIC Series



**MIC3+**  
MOTORTECH IGNITION CONTROLLER



**MIC4**  
MOTORTECH IGNITION CONTROLLER



**MIC5**  
MOTORTECH IGNITION CONTROLLER



**MIC6**  
MOTORTECH IGNITION CONTROLLER

### General

- For 2- and 4-stroke engines
- Ignition technology pulse width modulated
- Technical restriction to 6000 rpm
- Max. trigger impulses 16+1 or 500 teeth on the flywheel

### Technical Data & Features

- Ignition timing to 0.1° crankshaft
- Triggered by magnetic, Hall effect or inductive pickup
- Multiple ignition timing control via
  - Potentiometer (except MIC3+ and MIC6 series)
  - Speed curve
  - 0 to 20 mA analog input
  - 0 to 10 V analog input
- Multiple energy control via MOST (MOTORTECH Output Stage Technology)
- Programmable firing order
- Overspeed shutdown function
- Access controlled
- Programmable spark duration
- Energy output control
- 2 programmable speed curves with max. 8 speed points (speed/ignition timing)
- Diagnostic memory
- System status display
- Error memory

### Ignition Diagnostics

- Runtime data
- Alarm and error messages
- Data logging
- Primary and secondary misfire detection
- Cylinder individual high-voltage calculation (kV)

### Interfaces

- CAN Bus 2.0b interface (CANopen/SAE J1939 protocol)
- RS485 interface (Modbus RTU)
- USB 1.1 interface

### Inputs

- Binary ignition release (start/stop)
- Configurable binary input (GPI)
- Binary input for schedule A/B

### Outputs

- Max. 2 Auxiliary Synchronization Outputs (ASO) which can support a detonation control system (e.g. DetCon) or fuel injection pump controllers (device dependend)
- Max. 3 multipurpose outputs (GPO) (device dependend)
- Go/NoGo output

### Configuration

- Using the graphic user interface MICT (MOTORTECH Integrated Configuration Tool, see page 9)

### Certifications

- CSA (Class I, Division 2, Group C, D; T4)
- ATEX – on request
- CE

### Scope of Supply

- Configuration software MICT (MOTORTECH Integrated Configuration Tool)
- USB interlink cable
- Vibration dampers
- Ground strap
- Fastening material
- Operating manual

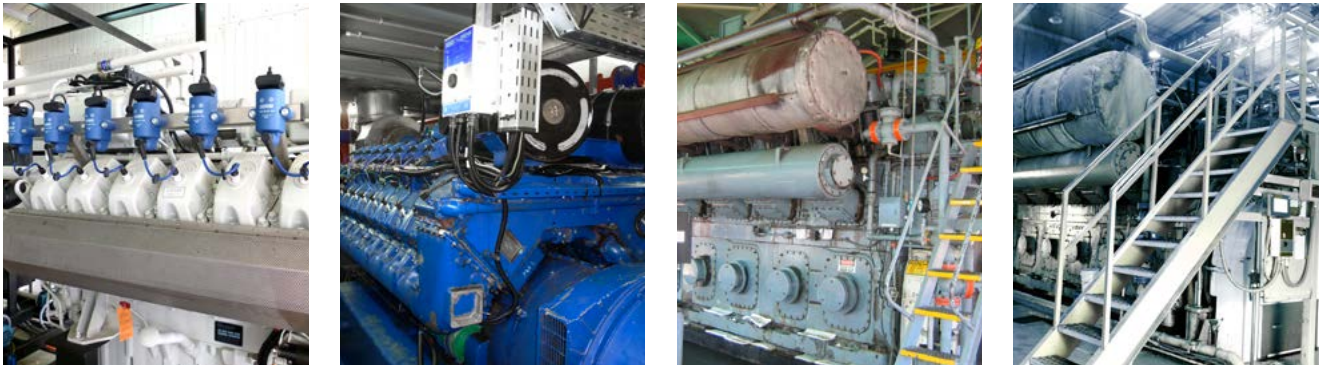

## Technical Data

Feature		MIC3+ Series	MIC4 Series	MIC5 Series	MIC6 Series
General	Max. number of ignition outputs	12	16	20	24
	Max. number of pickups	2	3	3	6 (2 sets with max. 3 pickups)
	Power supply	10 to 32 V DC	10 to 32 V DC	16.8 to 32 V DC	18 to 32 V DC
	Permitted housing surface temperature	-40 °C to + 60 °C -40 °F to +140 °F	-40 °C to + 60 °C (LD) -40 °F to +140 °F (LD)	-40 °C to + 60 °C -40 °F to +140 °F	-40 °C to + 60 °C -40 °F to +140 °F
Output	Max. primary voltage	250 V DC	250 V DC	250 V DC	250 V DC
	Max. ignition energy	300 mJ (500 mJ) boost for start phase	300 mJ (500 mJ) boost for start phase	500 mJ (600 mJ) boost for start phase	1000 mJ (1200 mJ) boost for start phase
	Max. programmable spark duration	100 to 800 µsec	100 to 1000 µsec	100 to 1500 µsec	100 to 1500 µsec
Housing	Available housing versions <sup>1)</sup>	Light Duty (LD)	Panel Mount (PM), Light Duty (LD), Heavy Duty (HD)	Heavy Duty (HD)	Heavy Duty (HD)
	Dimensions (length x width x height)	250 x 240 x 89.5 mm (LD) 9.84 x 9.45 x 3.52 in (LD)	304 x 240 x 95.5 mm (LD) 11.97 x 9.45 x 3.76 in (LD)	371 x 240 x 114.5 mm (HD) 14.61 x 9.45 x 4.51 in (HD)	385 x 240 x 114.5 mm (HD) 15.16 x 9.45 x 4.51 in (HD)
	Protection class	IP54 (LD)	IP20 (PM), IP54 (LD), IP65 (HD)	IP65 (HD)	IP65 (HD)
	Engine installation	not permitted	not permitted	not permitted	not permitted
	Number of potentiometers for manual timing adjustment	0	2 (continuous)	2 (continuous)	0
	Input connection	MIL, 35 pole, pin (standard)	terminal strip (standard)	terminal strip (standard)	MIL, 35 pole, pin (standard)
	Output connection	MIL, 17 pole, socket	MIL, 17 pole, socket	MIL, 35 pole, socket	MIL, 35 pole, socket
	Number of status LEDs	5	6	6	11

<sup>1)</sup> Consult factory for information on the availability of housing styles.

# Ignition Controllers & Harnesses



## Patented Technology for MIC3+/MIC4/MIC5/MIC6\*

Efficiency-enhanced engines, highly compressed mixtures, as well as the use of a great variety of gas types are putting greater demands on the entire ignition system, including:

- reliable ignition even with weak or fluctuating calorific values of the gas
- compliance with the strictest emission regulations
- avoidance of knocking and misfiring
- reduction of maintenance costs through longer spark plug runtimes

\*Patent No.: US 8,893,692 B2

The graphic compares the behavior of a conventional Capacitor Discharge Ignition System (CDI) and Ignition System with MOST

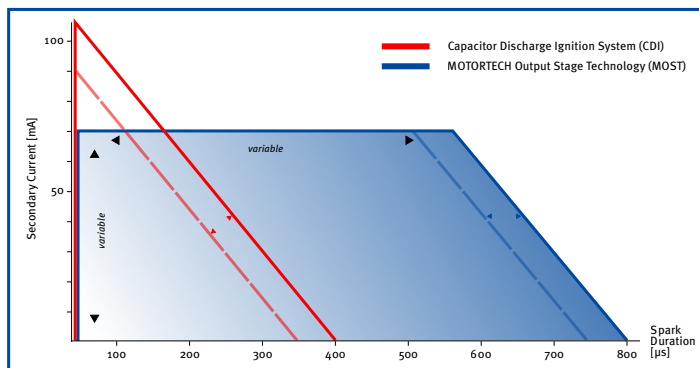

These requirements can only be met by precision ignition behavior and efficient control of the ignition spark. MOTORTECH Output Stage Technology (MOST) was developed by MOTORTECH for this.

## MOST works with the following principles:

- adjustable ignition spark duration with different available ignition voltages
- constant spark intensity via adjusted ignition spark duration
- 300 to 1000 mJ of primary energy (device dependent) are available

## Capacitor Discharge Ignition System (CDI)

The red curve shows that a high peak current is reached during ignition. Afterwards, the current decreases sharply. To achieve longer spark duration, the energy supply must be increased. The result of this is a higher peak current.

## Ignition System with MOST

The blue curve shows that a lower peak current is reached during ignition with MOST. The current remains at a constant level until the energy supply ends. Thereafter, the current drops. In this case as well, more energy is supplied for a longer spark duration, however the peak current is not increased in the process.

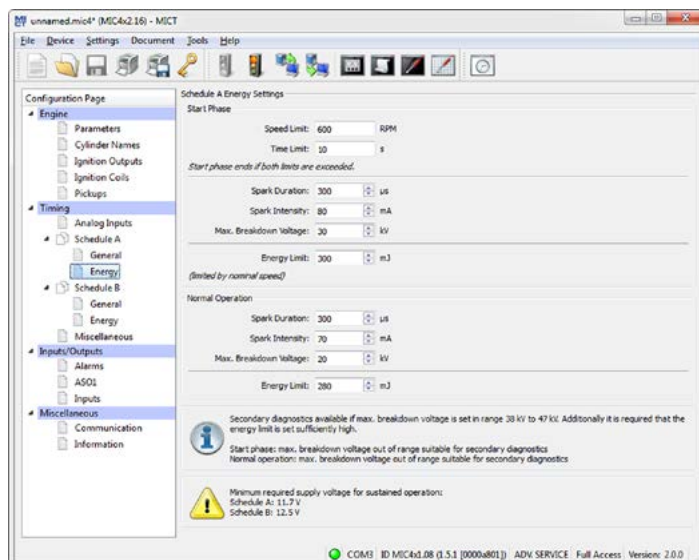

## Settings for MOST in MICT

The settings for MOST are made using the MICT configuration software. On the configuration side *Timing – Schedule A/B – Energy*, you can define different values for the spark duration, spark intensity, breakdown voltage and energy limit for the start phase and normal operation. That way starting difficulties of the engine can be caught. Different energy settings for the two schedules A and B support, for example, optimally matched two gas operation. The settings are dependent on the ignition coils that are used, among other things. They must be suitable for MOST and set correctly on the configuration side *Engine – Ignition Coils*. To optimize the energy settings for an engine, the ignition behavior must be observed and analyzed (misfiring, knock behavior, emission values, etc.). The secondary side diagnostics with MICT, among other things, can help here.



## MICT

MOTORTECH INTEGRATED CONFIGURATION TOOL

The MICT is the graphical user interface for all controllers of the MIC3+, MIC4, MIC5 and MIC6 series. With a laptop all configurations can be done and runtime data of the engine can be checked and adjusted.

- Language selectable (German/English/Chinese)
- Microsoft® Windows 7 and Windows 10 compatible
- Included data base offers engine information such as firing order, firing sequence, number of ignition coils per cylinder and typical number of teeth on flywheel for easy engine configuration
- Print function of a given moment in the operation can be used for external problem analysis, etc.
- Context sensitive online help
- Different access levels to avoid accidental misconfigurations

### Sample Screens – Runtime Data



#### Overview

In the overview schedule the most important current runtime data such as speed, ignition timing or system status can be registered at a glance.

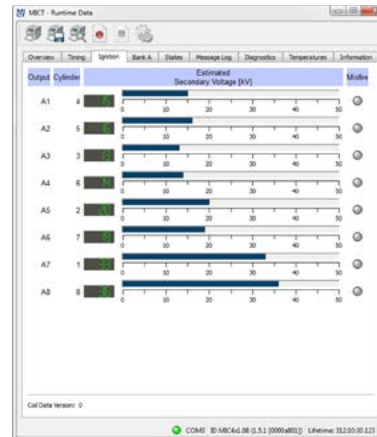

#### Breakdown Voltage

The MICT offers a lot of real time and detailed information about the status of each individual ignition output. Important data will be visually prepared, so that any irregularities will stand out easily. For example, secondary voltage will be displayed as bar graph, and the type of misfiring carries a warning light as symbol.

### Sample Screens – Parameter Set

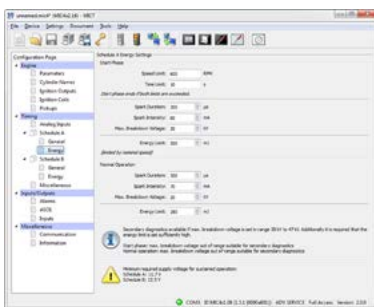

#### Energy Settings

For start phase and normal operation of the engine, durations at different high voltage levels and ignition spark intensity can be adjusted with the advanced energy settings.

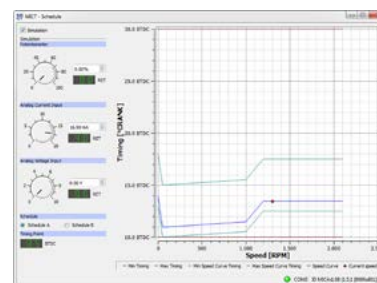

#### Configuration Visualization

The graphic display of the parameter set A and B offers a fast, visual control of the configured values.

# Ignition Controllers & Harnesses

## System Overview MIC3+/MIC4/MIC5 Series

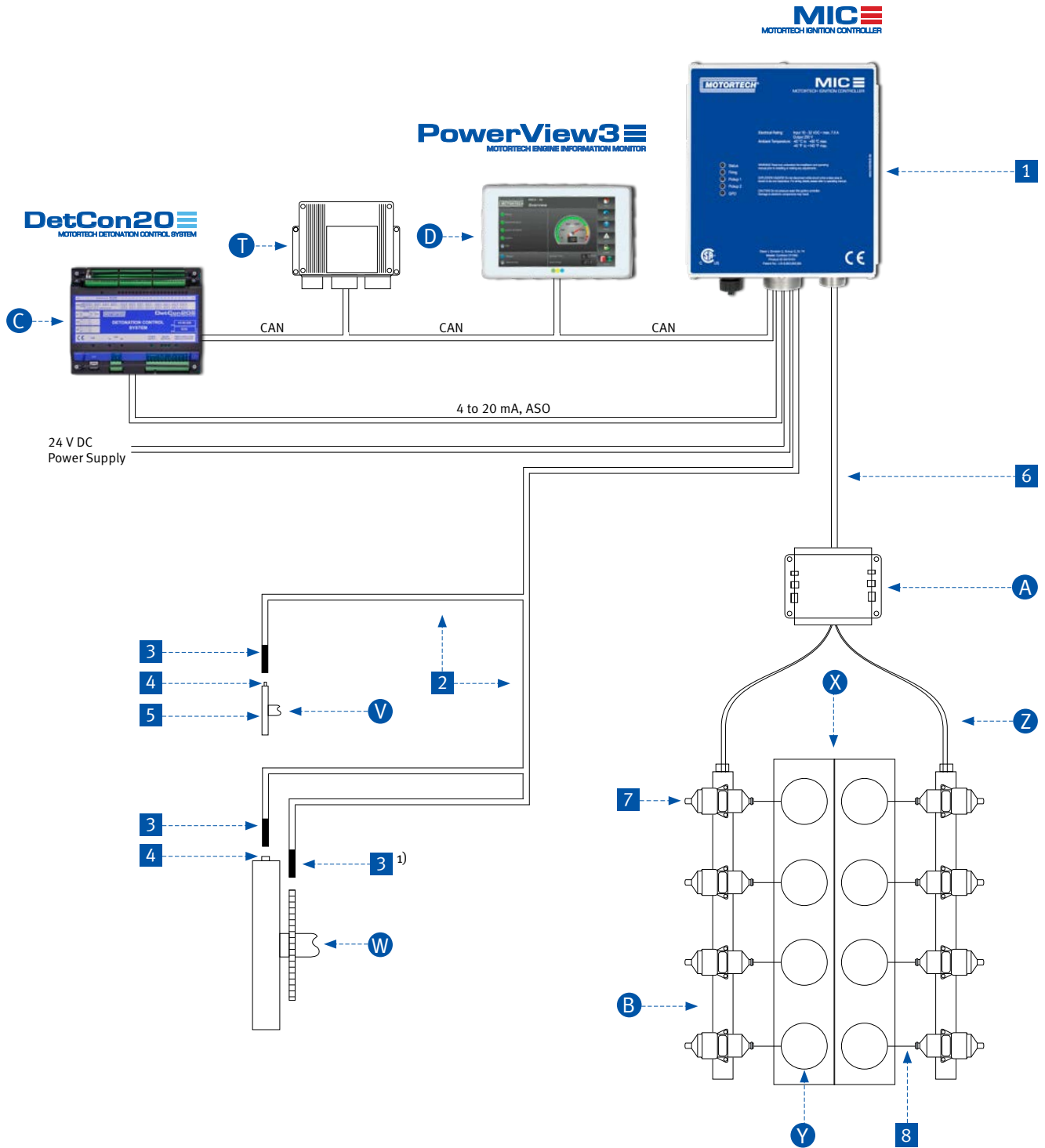

<sup>1)</sup> In combination with the MIC3+ series only one crankshaft pickup possible

## Legend

### Necessary Components

- 1 MIC ignition controller
- 2 Pickup lead\*
- 3 Pickup\*
- 4 Reluctor pins/trigger magnets

*alternative*

- 5 Trigger disc

*alternative*

Trigger drive

- 6 Output harness\*
- 7 Ignition coil\*
- 8 1 primary lead/spark plug lead per ignition coil\*

\* Shielded and unshielded versions available.

### Accessories

- A Junction box
- B AlphaRail/LiteRail – ignition wiring rail

### System Enhancement

- C DetCon20 – Detonation controller
- D PowerView3 – HMI module

### Description

- T Engine Control Unit (ECU)
- V Camshaft
- W Crankshaft
- X Engine
- Y Cylinder
- Z Harness to connect the ignition wiring rails and the junction box

## Established Pickup Arrangements

### 3-Pickup Arrangement for 4-Stroke Engines

- 1) Crankshaft (Reset)  
Magnetic pickup  
(holes, pins, teeth, screws)
- 2) Crankshaft (Speed)  
Magnetic pickup  
(holes, pins, teeth, screws)
- 3) Camshaft (Reset)  
Hall effect pickup  
(magnets)

*alternative*

- 3) Camshaft (Reset)  
Inductive pickup  
(pins, screws, slots)

### 1-Pickup Arrangement for 4-Stroke Engines

- 1) Camshaft (N+1/N-1)  
Hall effect pickup  
(disc with magnets)
- alternative*
- 1) Camshaft (N+1/N-1)  
Inductive pickup  
(disc with pins, screws, slots)

### 2-Pickup Arrangement for 2-Stroke Engines

- 1) Crankshaft (Reset)  
Magnetic pickup  
(holes, pins, teeth, screws)
- 2) Crankshaft (Speed)  
Magnetic pickup  
(holes, pins, teeth, screws)

# Ignition Controllers & Harnesses



## Ignition Controllers – Light Duty – Standard

P/N	max. Outputs	Connector Style	Connectors		Pickup		Equivalent to
			Input	Output	Inputs	Voltage	
66.00.350-6	6	MIL	35 pole, pin	17 pole, socket	2	programmable via MICT	
66.00.350-12	12	MIL	35 pole, pin	17 pole, socket	2	programmable via MICT	

## Input Harnesses for Ignition Controllers – Light Duty – Standard

P/N	Description	Interfaces	Connector	Length	Pickup
06.02.034-160	Input harness for P/N 66.00.350-6/-12	CAN Bus/RS485 (4 wire)	MIL, 35 pole, socket, 180°	160 in	1 inductive
06.02.035-160	Input harness for P/N 66.00.350-6/-12	CAN Bus/RS485 (4 wire)	MIL, 35 pole, socket, 180°	160 in	2 inductive
06.02.036-160	Input harness for P/N 66.00.350-6/-12	CAN Bus/RS485 (4 wire)	MIL, 35 pole, socket, 180°	160 in	1 Hall effect
06.02.040-160	Input harness for P/N 66.00.350-6/-12	RS485 (2 wire)	MIL, 35 pole, socket, 180°	160 in	1 Hall effect
06.02.041-160	Input harness for P/N 66.00.350-6/-12	CAN Bus/RS485 (4 wire)	MIL, 35 pole, socket, 180°	160 in	1 inductive, 1 magnetic

## Input Harnesses for Ignition Controllers – Light Duty – Standard <sup>1)</sup>



P/N	Description	Interfaces	Connector	Length	Pickup
95.30.300-L	Input harness for P/N 66.00.350-6/-12	CAN Bus (4 wire)	MIL, 35 pole, socket, 180°	L= 5/15/25/50 ft	1 inductive
95.30.301-L	Input harness for P/N 66.00.350-6/-12	CAN Bus (4 wire)	MIL, 35 pole, socket, 180°	L= 5/15/25/50 ft	1 Hall effect
95.30.302-L	Input harness for P/N 66.00.350-6/-12	CAN Bus (4 wire)	MIL, 35 pole, socket, 180°	L= 5/15/25/50 ft	1 magnetic

<sup>1)</sup> For CSA applications flex conduit has to be ordered separately or supplied by customer.

## Output Harnesses for Ignition Controllers – Light Duty – Standard

P/N	Description	Connector	Length	Equivalent to
06.02.618-L	Output harness for P/N 66.00.350-6/-12, 12 outputs max.	MIL, 17 pole, pin, 180°	L= 160/240/320 in	

## Output Harnesses for Ignition Controllers – Light Duty – Standard <sup>1)</sup>



P/N	Description	Connector	Length	Equivalent to
95.40.217-L	Output harness for P/N 66.00.350-6/-12, 16 outputs max.	MIL, 17 pole, pin, 180°	L= 5/15/25/50 ft	

<sup>1)</sup> For CSA applications flex conduit has to be ordered separately or supplied by customer.

## Output Adaptor Harnesses for Ignition Controllers – Light Duty – Standard – Interface to ALTRONIC® Ignition Controllers

P/N	Description	Connector	Length	Equivalent to
06.02.027	Output adaptor harness for P/N 66.00.350-6/-12, use to replace ALTRONIC® CD200 ignition controller P/N 791070-6, 791070-8, 8 outputs max.	MIL, 17 pole, pin, 180°	12 in	
06.02.028	Output adaptor harness for P/N 66.00.350-6/-12, use to replace ALTRONIC® CD200 ignition controller P/N 791070-12, 12 outputs max.	MIL, 17 pole, pin, 180°	12 in	
77.49.029-L	Output adaptor harness for P/N 66.00.350-6/-12, use to replace ALTRONIC® CPU95 ignition controller P/N 791950-16, 16 outputs max.	MIL, 17 pole, pin, 180°	L= 1/5/7/10 ft	





## Junction Box & Accessories

P/N	Figure	Description	Equivalent to
06.05.075	1	Junction box	593600-1
15.07.134	2	Flex conduit, 3/4 in, black <sup>1)</sup>	
15.07.231	3	Fitting, 3/4 in, junction box to flex conduit	

<sup>1)</sup> Flex conduit needs to be ordered in m/ft in required length.

## Ignition Controllers – Light Duty – Special – Retrofit for MOTORTECH MIC500 Ignition Controllers



P/N	max. Outputs	Connector Style	Connectors		Pickup		Equivalent to
			Input	Output	Inputs	Voltage	
66.00.361-8	8	MIL	10 pole, pin	10 pole, socket	1	programmable via MICT	06.00.520
66.00.362-12	12	MIL	10 pole, pin	14 pole, socket	1	programmable via MICT	06.00.525



1



2



3

# Ignition Controllers & Harnesses

**MIC3+CATDI**  
MOTORTECH IGNITION CONTROLLER

**MIC3+CEC**  
MOTORTECH IGNITION CONTROLLER

Based on the MIC3+ series, MOTORTECH produces special controllers as replacements for the OEM ignition systems used on **CATERPILLAR**® G3300 and G3400 and **WAUKESHA**® ATGL, VGF and VHP series gas engines. Designed as an exchange device, the MIC3+CATDI and MIC3+CEC enable a quick conversion without great effort.



## Ignition Controllers – Light Duty – Special – Retrofit for CATERPILLAR® G3300 and G3400 Series Gas Engines

P/N	max. Outputs	Connector Style	Connectors			Inputs	Pickup Voltage	Equivalent to
			Input	Output	Analog Input			
66.00.356-8 <sup>1)</sup>	8	MIL	6 pole, pin	10 pole, pin	10 pole, socket	1	programmable via MICT	CAT DI Model – P/N 163-6164, MOTORTECH MIC500 – P/N 06.00.513
66.00.357-12 <sup>2)</sup>	12	MIL	6 pole, pin	19 pole, pin	10 pole, socket	1	programmable via MICT	CAT DI Model – P/N 163-6108 MOTORTECH MIC500 – P/N 06.00.514

<sup>1)</sup> For use with G3304, G3306, G3406, G3408 <sup>2)</sup> For use with G3412

## Ignition Controllers – Light Duty – Special – Retrofit for WAUKESHA® ATGL, VGF and VHP Series Gas Engines

P/N	max. Outputs	Connector Style	Connectors			Inputs	Pickup Voltage	Equivalent to
			Input	Output	Analog Input			
66.00.358-8 <sup>1)</sup>	8	MIL	7 pole, pin	10 pole, pin	10 pole, socket	1	programmable via MICT	CEC Models 811/811A – P/N 740608A, 740608 – P/N 69786A, 69786 – P/N 69787B, 69787 MOTORTECH MIC500 – P/N 06.00.515-6/-8
66.00.359-12 <sup>2)</sup>	12	MIL	7 pole, pin	19 pole, pin	10 pole, socket	1	programmable via MICT	CEC Models 1211/1211A – P/N 740609A, 740609 – P/N 68788A, 69788 – P/N 69789B, 69789 MOTORTECH MIC500 – P/N 06.00.516

<sup>1)</sup> For use with 8L-AT27GL, VGF F18, H24 and VHP F2895, F3521

<sup>2)</sup> For use with 12V-AT25GL, 12V-AT27GL, VGF L36 and VHP L5108, L5790, L7042

## Analog Input Harness for Ignition Controllers – Light Duty – Special

P/N	Description	Connector	Length	Equivalent to
06.02.046-160	Analog input harness for P/N 66.00.356-8, 66.00.357-12, 66.00.358-8, 66.00.359-12	MIL, 10 pole, pin, 180°	160 in	

# Ignition Controllers & Harnesses



## Ignition Controllers – Light Duty – Standard

P/N	max. Outputs	Connector Style	Connectors		Inputs	Pickup Voltage	Equivalent to
			Input	Output			
66.00.410-8	8	MIL/terminal strip	terminal strip	17 pole, socket	3	programmable via MICT	
66.00.410-16	16	MIL/terminal strip	terminal strip	17 pole, socket	3	programmable via MICT	
66.00.424-8	8	MIL	35 pole, pin	17 pole, socket	2	programmable via MICT	
66.00.424-16	16	MIL	35 pole, pin	17 pole, socket	2	programmable via MICT	

Consult factory for availability of ATEX certified ignition controllers.

## Ignition Controllers – Panel Mount – Standard



P/N	max. Outputs	Connector Style	Connectors		Inputs	Pickup Voltage	Equivalent to
			Input	Output			
66.00.400-8	8	terminal strip	terminal strip	terminal strip	3	programmable via MICT	
66.00.400-16	16	terminal strip	terminal strip	terminal strip	3	programmable via MICT	

## Ignition Controllers – Heavy Duty – Standard



P/N	max. Outputs	Connector Style	Connectors		Inputs	Pickup Voltage	Equivalent to
			Input	Output			
66.00.440-8	8	MIL/terminal strip	terminal strip	17 pole, socket	3	programmable via MICT	
66.00.440-16	16	MIL/terminal strip	terminal strip	17 pole, socket	3	programmable via MICT	



Light Duty (LD)



Panel Mount (PM)



Heavy Duty (HD)

back

# Ignition Controllers & Harnesses

## Input Harnesses for Ignition Controllers – Light Duty – Standard

P/N	Description	Interfaces	Connector	Length	Pickup
06.02.034-160	Input harness for P/N 66.00.424-8/-16	CAN Bus/RS485 (4 wire)	MIL, 35 pole, socket, 180°	160 in	1 inductive
06.02.035-160	Input harness for P/N 66.00.424-8/-16	CAN Bus/RS485 (4 wire)	MIL, 35 pole, socket, 180°	160 in	2 inductive
06.02.036-160	Input harness for P/N 66.00.424-8/-16	CAN Bus/RS485 (4 wire)	MIL, 35 pole, socket, 180°	160 in	1 Hall effect
06.02.040-160	Input harness for P/N 66.00.424-8/-16	RS485 (2 wire)	MIL, 35 pole, socket, 180°	160 in	1 Hall effect
06.02.041-160	Input harness for P/N 66.00.424-8/-16	CAN Bus/RS485 (4 wire)	MIL, 35 pole, socket, 180°	160 in	1 inductive, 1 magnetic

## Input Harnesses for Ignition Controllers – Light Duty – Standard <sup>1)</sup>



P/N	Description	Interfaces	Connector	Length	Pickup
95.30.300-L	Input harness for P/N 66.00.424-8/-16	CAN Bus (4 wire)	MIL, 35 pole, socket, 180°	L= 5/15/25/50 ft	1 inductive
95.30.301-L	Input harness for P/N 66.00.424-8/-16	CAN Bus (4 wire)	MIL, 35 pole, socket, 180°	L= 5/15/25/50 ft	1 Hall effect
95.30.302-L	Input harness for P/N 66.00.424-8/-16	CAN Bus (4 wire)	MIL, 35 pole, socket, 180°	L= 5/15/25/50 ft	1 magnetic

<sup>1)</sup> For CSA applications flex conduit has to be ordered separately or supplied by customer.

## Output Harnesses for Ignition Controllers – Light Duty/Heavy Duty – Standard

P/N	Description	Connector	Length	Equivalent to
06.02.617-L	Output harness for P/N 66.00.410-8/-16, P/N 66.00.424-8/-16 and P/N 66.00.440-8/-16, 16 outputs max.	MIL, 17 pole, pin, 180°	L= 160/240/320 in	

## Output Harnesses for Ignition Controllers – Light Duty/Heavy Duty – Standard <sup>1)</sup>



P/N	Description	Connector	Length	Equivalent to
95.40.217-L	Output harness for P/N 66.00.410-8/-16, P/N 66.00.424-8/-16 and P/N 66.00.440-8/-16, 16 outputs max.	MIL, 17 pole, pin, 180°	L= 5/15/25/50 ft	

<sup>1)</sup> For CSA applications flex conduit has to be ordered separately or supplied by customer.

## Output Adaptor Harnesses for Ignition Controllers – Light Duty/Heavy Duty – Standard – Interface to ALTRONIC® Ignition Controllers

P/N	Description	Connector	Length	Equivalent to
06.02.027	Output adaptor harness for P/N 66.00.410-8/-16, P/N 66.00.424-8/-16 and P/N 66.00.440-8/-16, use to replace ALTRONIC® CD200 ignition controller P/N 791070-6 , 791070-8, 8 outputs max.	MIL, 17 pole, pin, 180°	12 in	
06.02.028	Output adaptor harness for P/N 66.00.410-8/-16, P/N 66.00.424-8/-16 and P/N 66.00.440-8/-16, use to replace ALTRONIC® CD200 ignition controller P/N 791070-12, 12 outputs max.	MIL, 17 pole, pin, 180°	12 in	
77.49.029-L	Output adaptor harness for P/N 66.00.410-8/-16, P/N 66.00.424-8/-16 and P/N 66.00.440-8/-16, use to replace ALTRONIC® CPU95 ignition controller P/N 791950-16, 16 outputs max.	MIL, 17 pole, pin, 180°	L= 1/5/7/10 ft	





## Junction Box & Accessories

P/N	Figure	Description	Equivalent to
06.05.075	<a href="#">1</a>	Junction box	593600-1
15.07.134	<a href="#">2</a>	Flex conduit, 3/4 in, black <sup>1)</sup>	
15.07.231	<a href="#">3</a>	Fitting, 3/4 in, junction box to flex conduit	

<sup>1)</sup> Flex conduit needs to be ordered in m/ft in required length.

## Ignition Controllers – Light Duty – Special – Retrofit for MOTORTECH MIC500 and MWM® TEM-ZS Ignition Controllers



P/N	max. Outputs	Connector Style	Connectors		Inputs	Pickup	Equivalent to
			Input	Output		Voltage	
66.00.413-16	16	MIL	10 pole, pin	19 pole, socket	1	programmable via MICT	06.00.530
66.00.427-16 <sup>1)</sup>	16	MIL	3/5 pole, pin, 14 pole, socket	19 pole, socket	2	programmable via MICT	MWM®/DEUTZ® TEM-ZS1 - P/N 1229 8101 KM MWM®/DEUTZ® TEM-ZS3 - P/N 1232 0993 KM



<sup>1)</sup> **NOTE:** Can be used for conversions of MWM® TEM-ZS ignition controllers only when TEM engine management system is also replaced by ALL-IN-ONE. Requires use of input harness P/N 06.02.055-600 in addition.

## Input Harness for Ignition Controllers – Light Duty – Special – Retrofit for MWM® TEM-ZS Ignition Controllers

P/N	Description	Connector	Length	Equivalent to
06.02.055-600	Input harness for P/N 66.00.427-16 (CAN, ASO, analog/binary inputs)	MIL, 14 pole, pin, 180°	600 in	

## Bracket Sets for Conversions

P/N	Description	Equivalent to
75.10.404	Bracket set for conversion of ALTRONIC® CPU95 ignition controller to MIC4 Light Duty/Heavy Duty	
75.30.146	Universal adaptor plate – MIC4 Light Duty/Heavy Duty	



[1](#)



[2](#)



[3](#)

# Ignition Controllers & Harnesses



## MIC4-ZS MOTORTECH IGNITION CONTROLLER

Based on the MIC4 series, MOTORTECH produces a special controller version as a replacement for the TEM-ZS1 and TEM-ZS3 ignition system used on **MWM®/DEUTZ®** gas engines. Designed as an exchange device, the MIC4-ZS enables a quick conversion without great effort.

In addition to the MIC4-ZS ignition controller, the prepared conversion kits include the required high-performance ignition coils. Pre-chamber spark plugs or spark plug leads can be re-used, as these ignition coils have the same secondary connections as the original ones. The ignition coils – designed for MOTORTECH ignition controllers with MOST technology – guarantee the ideal performance support, especially when it comes to alternative combustibles with alternating or relatively low fuel value, e.g. biogas, mine gas, woodgas, sewage gas, landfill gas etc.



Scan QR Code®

### MIC4-ZS Kits

P/N	Description	Quantity	Equivalent to
75.30.150-08	MIC4-ZS kit for MWM®/DEUTZ® 8 cylinder gas engines <i>Contains:</i> <ul style="list-style-type: none"> <li>■ MIC4-ZS ignition controller P/N 66.00.425-16</li> <li>■ High-performance ignition coil P/N 06.50.065</li> </ul>	1 pc 8 pcs	MWM®/DEUTZ® TEM-ZS1 – P/N 1229 8101 KM MWM®/DEUTZ® TEM-ZS3 – P/N 1232 0993 KM
75.30.150-12	MIC4-ZS kit for MWM®/DEUTZ® 12 cylinder gas engines <i>Contains:</i> <ul style="list-style-type: none"> <li>■ MIC4-ZS ignition controller P/N 66.00.425-16</li> <li>■ High-performance ignition coil P/N 06.50.065</li> </ul>	1 pc 12 pcs	MWM®/DEUTZ® TEM-ZS1 – P/N 1229 8101 KM MWM®/DEUTZ® TEM-ZS3 – P/N 1232 0993 KM
75.30.150-16	MIC4-ZS kit for MWM®/DEUTZ® 16 cylinder gas engines <i>Contains:</i> <ul style="list-style-type: none"> <li>■ MIC4-ZS ignition controller P/N 66.00.425-16</li> <li>■ High-performance ignition coil P/N 06.50.065</li> </ul>	1 pc 16 pcs	MWM®/DEUTZ® TEM-ZS1 – P/N 1229 8101 KM MWM®/DEUTZ® TEM-ZS3 – P/N 1232 0993 KM

### Accessories (optional)

P/N	Description	Quantity	Equivalent to
06.85.179-20	PolyMot™ spark plug lead for MWM®/DEUTZ® gas engines <ul style="list-style-type: none"> <li>■ TBG620 series</li> <li>■ TCG2020 series</li> </ul>	8, 12 or 16 pcs per kit	1230 0136
06.85.310H-11	PolyMot™ spark plug lead for MWM®/DEUTZ® gas engines <ul style="list-style-type: none"> <li>■ TBG616 series</li> <li>■ TCG2016 series</li> </ul>	8, 12 or 16 pcs per kit	1227 8370
GL3-3	DENSO® spark plug <ul style="list-style-type: none"> <li>■ Thread size M18x1.5, thread reach 0.750 in (19.0 mm)</li> <li>■ J-type electrode design (Ir/Pt)</li> <li>■ HEX 13/16 in (20.8 mm)</li> <li>■ <b>Recommended for natural gas applications</b></li> </ul>	8, 12 or 16 pcs per kit	– 1242 0290, RB75WPCC-1 – 1242 0480, 18GZ5-77-2
GL3-5	DENSO® spark plug <ul style="list-style-type: none"> <li>■ Thread size M18x1.5, thread reach 0.750 in (19.0 mm)</li> <li>■ J-type electrode design (Ir/Ir)</li> <li>■ HEX 13/16 in (20.8 mm)</li> <li>■ <b>Recommended for special gas/natural gas applications</b></li> </ul>	8, 12 or 16 pcs per kit	– 1242 0290, RB75WPCC-1 – 1242 0480, 18GZ5-77-2
alternative B8324	MOTORTECH MHP spark plug <ul style="list-style-type: none"> <li>■ Thread size M18x1.5, thread reach 0.750 in (19.0 mm)</li> <li>■ J-type electrode design (Ir/Ir)</li> <li>■ HEX 13/16 in (20.8 mm)</li> <li>■ <b>Recommended for special gas/natural gas applications</b></li> </ul>	8, 12 or 16 pcs per kit	1242 0290, 1242 0480

# Ignition Controllers & Harnesses



## Ignition Controllers – Heavy Duty – Standard

P/N	max. Outputs	Connector Style	Connectors		Pickup		Equivalent to
			Input	Output	Inputs	Voltage	
66.00.540-20	20	MIL/terminal strip	terminal strip	35 pole, socket	3	programmable via MICT	MIC850 P/N 66.00.855-24/-24-D
66.00.541-20	20	MIL	35 pole, pin	35 pole, socket	2	programmable via MICT	
66.00.544-20	20	MIL	35 pole, pin	14/17 pole, socket	3	programmable via MICT	

## Input Harnesses for Ignition Controllers – Heavy Duty – Standard

P/N	Description	Interfaces	Connector	Length	Pickup
06.02.034-160	Input harness for P/N 66.00.541-20	CAN Bus/RS485 (4 wire)	MIL, 35 pole, socket, 180°	160 in	1 inductive
06.02.035-160	Input harness for P/N 66.00.541-20	CAN Bus/RS485 (4 wire)	MIL, 35 pole, socket, 180°	160 in	2 inductive
06.02.036-160	Input harness for P/N 66.00.541-20	CAN Bus/RS485 (4 wire)	MIL, 35 pole, socket, 180°	160 in	1 Hall effect
06.02.040-160	Input harness for P/N 66.00.541-20	RS485 (2 wire)	MIL, 35 pole, socket, 180°	160 in	1 Hall effect
06.02.041-160	Input harness for P/N 66.00.541-20	CAN Bus/RS485 (4 wire)	MIL, 35 pole, socket, 180°	160 in	1 inductive, 1 magnetic
06.02.048-160	Input harness for P/N 66.00.544-20	CAN Bus (4 wire)	MIL, 35 pole, socket, 180°	160 in	1 inductive, 2 magnetic

## Input Harnesses for Ignition Controllers – Light Duty – Standard <sup>1)</sup>



P/N	Description	Interfaces	Connector	Length	Pickup
95.30.300-L	Input harness for P/N 66.00.541-20	CAN Bus (4 wire)	MIL, 35 pole, socket, 180°	L= 5/15/25/50 ft	1 inductive
95.30.301-L	Input harness for P/N 66.00.541-20	CAN Bus (4 wire)	MIL, 35 pole, socket, 180°	L= 5/15/25/50 ft	1 Hall effect
95.30.302-L	Input harness for P/N 66.00.541-20	CAN Bus (4 wire)	MIL, 35 pole, socket, 180°	L= 5/15/25/50 ft	1 magnetic

<sup>1)</sup> For CSA applications flex conduit has to be ordered separately or supplied by customer.

## Output Harnesses for Ignition Controllers – Heavy Duty – Standard <sup>1)</sup>



P/N	Description	Connector	Length	Equivalent to
95.40.235-L	Output harness for P/N 66.00.540-20 and P/N 66.00.541-20, 24 outputs max.	MIL, 35 pole, pin, 180°	L= 5/15/25/50 ft	

<sup>1)</sup> For CSA applications flex conduit has to be ordered separately or supplied by customer.

## Ignition Controllers – Heavy Duty – Special



P/N	max. Outputs	Connector Style	Connectors		Pickup		Equivalent to
			Input	Output	Inputs	Voltage	
66.00.542-20	20	MIL/terminal strip	terminal strip	14/17 pole, socket	3	programmable via MICT	WOODWARD® IC9xx, MIC850 P/N 66.00.851-24/-24-D

Consult factory for availability of ATEX certified ignition controllers.

# Ignition Controllers & Harnesses



## Output Harnesses for Ignition Controllers – Heavy Duty – Standard/Special <sup>1)</sup>

P/N	Description	Connector	Length	Equivalent to
95.40.214-L	Output harness for P/N 66.00.542-20 and P/N 66.00.544-20, 12 outputs max.	MIL, 14 pole, pin, 180°	L= 5/15/25/50 ft	
95.40.217-L	Output harness for P/N 66.00.542-20 and P/N 66.00.544-20, 16 outputs max.	MIL, 17 pole, pin, 180°	L= 5/15/25/50 ft	

<sup>1)</sup> For CSA applications flex conduit has to be ordered separately or supplied by customer.

## Output Adaptor Harnesses for Ignition Controllers – Heavy Duty – Standard/Special

P/N	Description	Connector	Length	Equivalent to
77.49.006	Output adaptor harness for P/N 66.00.540-20 and P/N 66.00.541-20, use to replace WOODWARD® IC9xx ignition controller and MIC850 P/N 66.00.851-24/-24-D, 24 outputs max.	MIL, 35 pole, pin, 180°	16 in	
77.49.007-L	Output adaptor harness for P/N 66.00.540-20 and P/N 66.00.541-20, use to replace ALTRONIC® CPU95 ignition controller P/N 791950-16, 16 outputs max.	MIL, 35 pole, pin, 90°	L= 1/5/7/10 ft	
77.49.008	Output adaptor harness for P/N 66.00.540-20 and P/N 66.00.541-20, use to replace MIC750 ignition controller P/N 66.00.750/-D, 16 outputs max.	MIL, 35 pole, pin, 90°	16 in	



## Junction Box & Accessories

P/N	Figure	Description	Equivalent to
06.05.075	<b>1</b>	Junction box	593600-1
15.07.134	<b>2</b>	Flex conduit, 3/4 in, black <sup>1)</sup>	
15.07.231	<b>3</b>	Fitting, 3/4 in, junction box to flex conduit	

<sup>1)</sup> Flex conduit needs to be ordered in m/ft in required length.



**1**



**2**



**3**



## MIC6 MOTORTECH IGNITION CONTROLLER

### MIC6 Ignition Controller For Stationary and Marine Applications

MOTORTECH expands its MIC product line with the new MIC6 series. The latest development is ideally suited for medium and high speed applications and convinces with a future oriented electronical concept for more power and a significantly higher degree of efficiency. The specially developed MIC6-Marine version meets the strict technical requirements of marine applications and certification societies and comes with extra features like a redundant pickup setup.



#### General

- For medium (up to 900 rpm nominal) and high speed applications (up to 1800 rpm nominal)
- 1000 mJ primary energy max.
- Adjustable spark duration and intensity
- Constant spark intensity via adjusted duration
- 6 pickup inputs for redundant pickup setup

#### Technical Data & Features

- 18 to 32 V DC supply voltage
- 24 ignition outputs
- 250 V DC primary voltage
- 1000 mJ primary energy (when firing 24 outputs at 900 rpm)  
600 mJ primary energy (when firing 24 outputs at 1800 rpm)
- 0.1° crankshaft accuracy
- 6 pickup inputs for integration of 2 redundant pickup sets
- Triggered by 1, 2 or 3 pickups per set (magnetic, Hall effect or inductive/configurable)
- Multiple ignition timing control via
  - Speed curve
  - 0 to 20 mA analog input
  - 0 to 10 V analog input
- Multiple energy control via MOST (MOTORTECH Output Stage Technology)
- Programmable firing order
- 3 multipurpose outputs (GPO)
- 2 Auxiliary Synchronization Outputs (ASO) which can support a detonation control system (e.g. DetCon) or fuel injection pump controllers
- Ignition release input
- Go/NoGo output
- Overspeed shutdown function
- Access controlled

- Ignition diagnostics (primary and secondary)
- More internal memory for faster signal processing and trend data for advanced diagnostics
- Integrated CANopen and RS485 (Modbus RTU) interface
- Easy access per USB port

#### Ignition Diagnostics

- Runtime data
- Alarm and error messages
- Data logging
- Primary and secondary misfire detection
- Cylinder individual high voltage calculation (kV)
- 11 LEDs provide a quick system state overview

#### Interfaces

- CAN Bus 2.0b interface (CANopen/SAE J1939 protocol)
- RS485 interface (Modbus RTU)
- USB 1.1 interface

#### Configuration

- Using the graphic user interface MICT (MOTORTECH Integrated Configuration Tool)

#### Housing/Connections

- Protection class IP65
- MIL style connectors

#### Certifications

- CSA (Class I, Division 2, Group C, D; T4)
- Marine type approval certification in accordance with
  - DNV GL
  - Bureau Veritas
  - Lloyd's Register
  - ABS
- ATEX – on request
- CE

# Ignition Controllers & Harnesses

## System Overview MIC6 Series

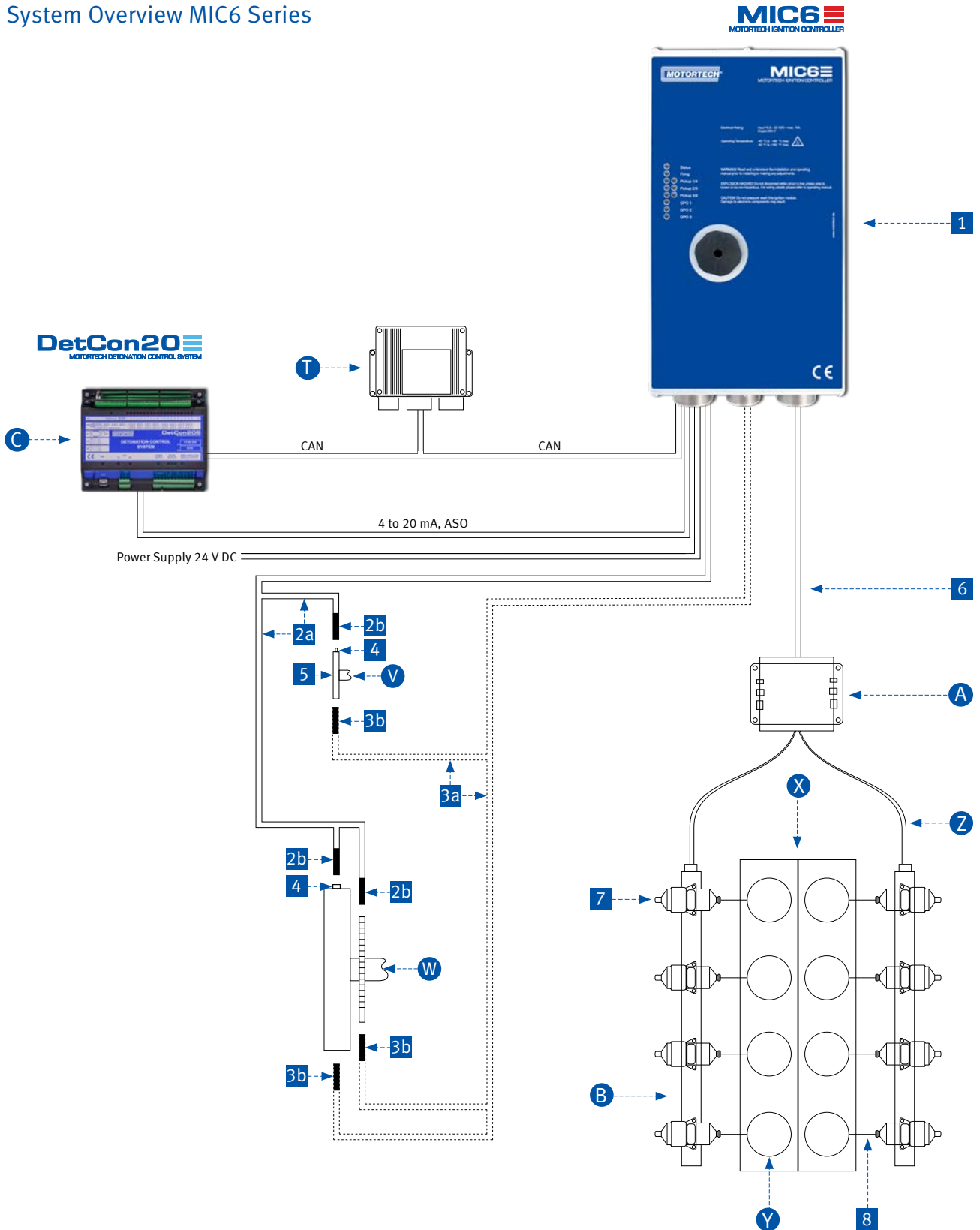

## Legend

### Necessary Components

- 1 MIC6 ignition controller
- 2 Pickup – Set 1
  - 2a Pickup lead\*
  - 2b Pickup\*
- 3 Pickup – Set 2  
(for redundant purposes)
  - 3a Pickup lead\*
  - 3b Pickup\*
- 4 Reluctor pins/trigger magnets  
*alternative*
- 5 Trigger disc  
*alternative*  
Trigger drive
- 6 Output harness\*
- 7 Ignition coil\*
- 8 1 primary lead/spark plug lead per ignition coil\*

\* Shielded and unshielded versions available.

### Accessories

- A Junction box
- B AlphaRail/LiteRail – ignition wiring rail

### System Enhancement

- C DetCon20 – Detonation controller

### Description

- T Engine Control Unit (ECU)
- V Camshaft
- W Crankshaft
- X Engine
- Y Cylinder
- Z Harness to connect the ignition wiring rails and the junction box

## Established Pickup Arrangements

### 3-Pickup Arrangement for 4-Stroke Engines

- 1) Crankshaft (Reset)  
Magnetic pickup  
(holes, pins, teeth, screws)
- 2) Crankshaft (Speed)  
Magnetic pickup  
(holes, pins, teeth, screws)
- 3) Camshaft (Reset)  
Hall effect pickup  
(magnets)

*alternative*

- 3) Camshaft (Reset)  
Inductive pickup  
(pins, screws, slots)

### 1-Pickup Arrangement for 4-Stroke Engines

- 1) Camshaft (N+1/N-1)  
Hall effect pickup  
(disc with magnets)
- alternative*
- 1) Camshaft (N+1/N-1)  
Inductive pickup  
(disc with pins, screws, slots)

### 2-Pickup Arrangement for 2-Stroke Engines

- 1) Crankshaft (Reset)  
Magnetic pickup  
(holes, pins, teeth, screws)
- 2) Crankshaft (Speed)  
Magnetic pickup  
(holes, pins, teeth, screws)

# Ignition Controllers & Harnesses



## For Stationary Applications

Ignition Controllers – **Heavy Duty** – Standard – For High Speed Applications <sup>1)</sup>

P/N	max. Outputs	Connector Style	Connectors		Pickup		Equivalent to
			Input	Output	Inputs	Voltage	
66.00.645-24	24	MIL	35 pole, pin	35 pole, socket	3	programmable via MICT	
66.00.646-24	24	MIL	35/26 pole, pin	35 pole, socket	6	programmable via MICT	

<sup>1)</sup> Consult factory for ignition controllers for medium speed applications.

## Input Harnesses for Ignition Controllers – **Heavy Duty** – Standard

P/N	Description	Interfaces	Connector	Length	Pickup
06.02.048-160	Input harness for P/N 66.00.645-24 and P/N 66.00.646-24	CAN Bus (4 wire)	MIL, 35 pole, socket, 180°	160 in	1 inductive, 2 magnetic
06.02.049-160	Input harness for P/N 66.00.646-24	CAN Bus/RS485 (4 wire)	MIL, 26 pole, socket, 180°	160 in	1 inductive, 2 magnetic

## Output Harnesses for Ignition Controllers – **Heavy Duty** – Standard <sup>1)</sup>



P/N	Description	Connector	Length	Equivalent to
95.40.235-L	Output harness for P/N 66.00.645-24 and P/N 66.00.646-24, 24 outputs max.	MIL, 35 pole, pin, 180°	L= 5/15/25/50 ft	

<sup>1)</sup> For CSA applications flex conduit has to be ordered separately or supplied by customer.

## Junction Box & Accessories



P/N	Figure	Description	Equivalent to
06.05.075	<b>1</b>	Junction box	593600-1
15.07.134	<b>2</b>	Flex conduit, 3/4 in, black <sup>1)</sup>	
15.07.231	<b>3</b>	Fitting, 3/4 in, junction box to flex conduit	

<sup>1)</sup> Flex conduit needs to be ordered in m/ft in required length.



**1**



**2**



**3**

# Ignition Controllers & Harnesses



## MIC6-Marine

MOTORTECH IGNITION CONTROLLER



For Marine Applications

Ignition Controllers – **Heavy Duty** – Standard – For High Speed Applications<sup>1)</sup>

MOST

P/N	max. Outputs	Connector Style	Connectors		Pickup		Equivalent to
			Input	Output	Inputs	Voltage	
92.00.646-24	24	MIL	35/26 pole, pin	35 pole, socket	6	programmable via MICT	

<sup>1)</sup> Consult factory for ignition controllers for medium speed applications.

Input Harnesses for Ignition Controllers – **Heavy Duty** – Standard<sup>1)</sup>

P/N	Description	Interfaces	Connector	Length	Pickup
92.02.001-160	Input harness for P/N 92.00.646-24	CAN Bus (4 wire)	MIL, 35 pole, socket, 180°	160 in	1 inductive, 2 magnetic
92.02.002-160	Input harness for P/N 92.00.646-24	CAN Bus/RS485 (4 wire)	MIL, 26 pole, socket, 180°	160 in	1 inductive, 2 magnetic

<sup>1)</sup> **NOTE:** Please consult factory for individual layout of Marine certified output harnesses.





# Ignition Controllers & Harnesses



## Ignition Control Visualization

The operating data of MIC3/3+, MIC4 and MIC5 series ignition controllers will be completely visualized via HMI module (Human Machine Interface). The overview screen shows the relevant information as engine speed, ignition timing and status of pickups, ignition outputs or active parameter set. The PowerView3 also allows adjustment of various ignition parameters such as ignition timing and energy. Functions as the self-test for error diagnostics can also be executed via HMI module. The control keys guarantee simple navigation through different display pages and menus. All in all the PowerView3 HMI module is also able to provide error diagnostics on-site without requiring a laptop!

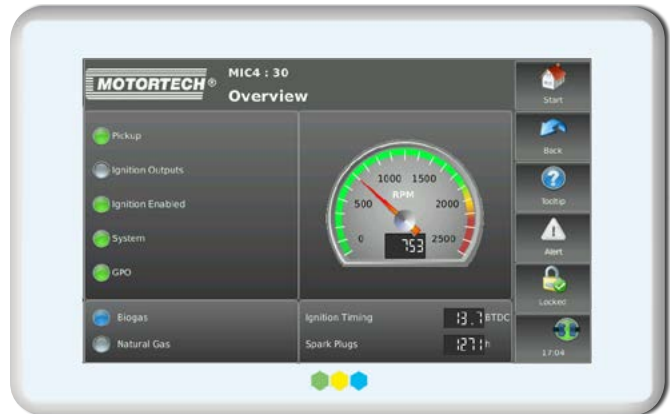

1

The PowerView3 is also available for data visualization of:

- DetCon Detonation Control
- TempScan20 Temperature Module

### General Features

- Visualization of ignition, detonation and temperature control via CAN bus
- Access control
- Display of CAN connection status
- Several display configurations (languages, date, display calibration, etc.)
- For assembly in control panels
- Day and night mode
- CSA® certified (Class I, Division 2, Group C, D; T4)

### Ignition Control (MIC3/3+/MIC4/MIC5 series)

- Overview with status indication for
  - Pickup signals
  - Active schedule
  - Analog display of engine speed
  - Ignition timing
  - Spark plugs (operating hours)
- Display of global ignition timing dependent on
  - Base ignition timing
  - Potentiometer adjustment
  - Analog current and voltage input
  - Speed curve
- Displays the ignition of each cylinder
  - Ignition voltage
  - Misfires
- Display of misfires
  - Primary and secondary sided wiring errors
  - Type of error (no connection/short circuit)
- Display and adjustment of energy
  - Spark duration
  - Spark intensity
- Display and adjustment of firing angles and ignition energy
- Self-test activation
- Warning, alarm and error messages

## Sample Screens – MIC3/3+/MIC4/MIC5

### MIC Overview



- Status displays (pickup, ignition outputs, ignition enabled, system status, schedule)
- Displays the current engine speed
- Shows the current global ignition timing in ° crankshaft
- Displays the previous operating hours of the spark plugs

### Ignition



- Displays the estimated ignition voltage for each individual cylinder
- Display of current and past misfires of each individual cylinder

### Secondary Voltage

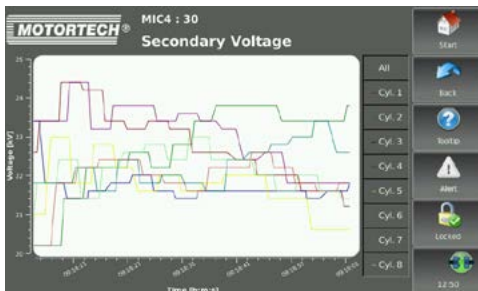

- Display of estimated secondary voltage of all selected cylinders
- Cylinders can be displayed and hidden individually
- Zoom function for detailed view of secondary voltage
- Navigation within the timeline

### PowerView3 HMI Modules & Activation Codes



P/N	Figure	Description
06.05.085	1	PowerView3 HMI module
06.05.185	2	PowerView3 HMI module, built into stainless steel enclosure
06.05.186	3	PowerView3 HMI modules (2 pcs), built into stainless steel enclosure, incl. activation codes for visualization of MIC3/3+/MIC4/MIC5 data, for use with dual ignition controller applications
06.05.187	4	PowerView3 HMI module, built into steel enclosure with sight window
06.05.086-F		PowerView3 activation code for visualization of MIC3/3+/MIC4/MIC5 data – Activation code has to be ordered separately with each PowerView3 HMI module
06.05.086-U		PowerView3 activation code for visualization of MIC3/3+/MIC4/MIC5 data – Only available for upgrade of existing PowerView3 HMI module in the field



# Ignition Controllers & Harnesses



The self-powered MOT601 is a capacitor discharge ignition system for use on spark-ignited, single cylinder gas engines with large flywheels. Closely mounted to the engine's flywheel, the electronic components are supplied with power by magnetic charging circuitry.

## Features

- Applicable for single cylinder engines with different flywheel sizes
- Self-powered electromagnetic system, no need for external power
- High primary energy
- Using crankshaft reference timing
- High accuracy ignition timing
- Two separate ignition timings (startup and nominal)
- Safety shutdown input
- Supplies panel power



## Benefits

- Price effective system and accessories
- Mainly maintenance-free system due to non-moving parts that wear out
- All components are available as spare parts and can be used with competitive systems
- 1 year warranty



## Mode of Operation

The charging bar **5** with three strong magnets attached to the flywheel passes the charging generator **3** that is attached to the engine in a fixed position at every revolution of the flywheel. At every revolution the generator module charges a capacitor in the ignition module **2** as a result of the magnetic field.

The trigger bar **6** with two magnets, which is likewise attached to the flywheel, passes a pickup coil **4** that is attached to the engine in a fixed position at every revolution of the engine. When the trigger bar passes the pickup coil, the energy stored in the capacitor is discharged into the attached ignition coil **7**.

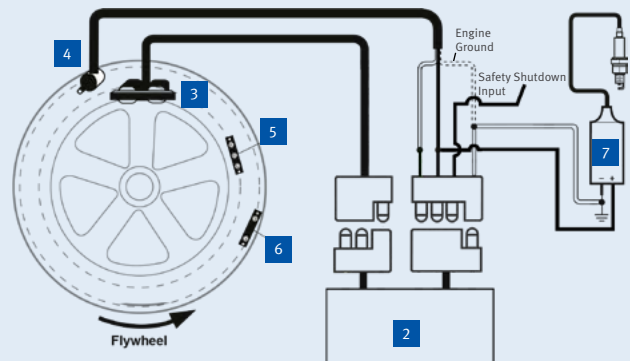

# Ignition Controllers & Harnesses



## Ignition System for Single Cylinder Engines

P/N	Figure	Description	Equivalent to
MOT601	1	MOT601 ignition system for single cylinder engines	AEI® FM601, ARROW® SFI-KIT, MURPHY® 72-70-0125

## Subcomponents

P/N	Figure	Description	Equivalent to
M-400A-8814	2	Electronic ignition module	AEI® 400A-8814, ARROW® A400A-8814, MURPHY® 72-00-0024,
M-260D-8810	3	Charging generator	AEI® 260D-8810, ARROW® A260D-8810, MURPHY® 72-00-0025
M-270A-8817	4	Magnetic pickup harness	AEI® 270A-8817, ARROW® A400A-8817, MURPHY® 72-00-0026
M-400A-8813	5	Magnetic charging bar	AEI® 400A-8813, ARROW® A400A-8813, MURPHY® 72-00-0027
M-400A-8811	6	Magnetic trigger bar	AEI® 400A-8811, ARROW® A400A-8811, MURPHY® 72-00-0028
06.50.055	7	Ignition coil	AEI® 1187, ARROW® 330-2-AI-46, MURPHY® 72-70-0235

MOT601 Single Cylinder Ignition System

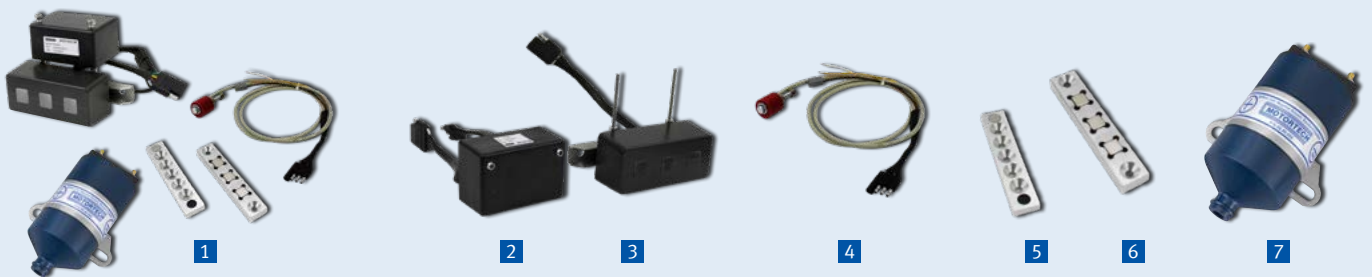

# Ignition Controllers & Harnesses

## UNSHIELDED

### Harnesses for Competition Ignition Control Systems

For use with competitor ignition systems, MOTORTECH offers a special range of harnesses. Based on the reliable design and quality of MOTORTECH's standard harnesses, this series represents a suitable replacement for existing harnesses in the field.



### Output Harnesses for ALTRONIC® Ignition Systems – For Unshielded Applications

P/N	Figure	Description	Connector	Length	Equivalent to
06.31.030-1	1	Output harness for ALT III ignition magneto, for unshielded applications up to 8 cylinders	MIL, 14 pole, socket, 180°	180 in	393018-1, 2W-3742, 69703, 178622
06.31.030-2	1	Output harness for ALT III ignition magneto, for unshielded applications up to 12 cylinders	MIL, 14 pole, socket, 180°	180 in	393018-2, 2W-3744, 269717B
06.31.032-1	1	Output harness for ALT III/III-CPU/V ignition magneto, CPU95-EVS (ignition unit to J-Box or DC-DC power supply), for unshielded applications up to 6 cylinders	MIL, 7 pole, socket, 180°	72 in	393023-1
06.31.032-2	1	Output harness for ALT III/III-CPU/V ignition magneto, CPU95-EVS (ignition unit to J-Box or DC-DC power supply), for unshielded applications up to 6 cylinders	MIL, 7 pole, socket, 180°	180 in	393023-2, 2W-3748, 69692B
06.70.191-180	1	Output harness for DISN800C, DISN801M, CD200D, CPU90, CPU95, CPU95EVS, for unshielded applications up to 12 cylinders	MIL, 19 pole, socket, 180°	180 in	793012-6, 793012-8, 793012-12
06.77.006-72	1	Output harness for ALT V ignition magneto, for unshielded applications up to 6 cylinders	MIL, 5 pole, socket, 180°	72 in	593041-1, 209728
06.77.006-96	1	Output harness for ALT V ignition magneto, for unshielded applications up to 6 cylinders	MIL, 5 pole, socket, 180°	96 in	593041-2



1



2



3



4



5



6



## Output Harnesses for ALTRONIC® Ignition Systems – For Shielded Applications

P/N	Figure	Description	Connector	Length		Equivalent to
				Conduit	Conductor	
95.30.007-1	2	Output harness for ALT III/III-CPU ignition magneto, for shielded applications up to 6 cylinders	MIL, 7 pole, socket, 90°	48 in	72 in	393013-1, 393013-3, 393013-7, 178788, 033-099-004, 208502E, BM-11533-B
95.30.007-2	2	Output harness for ALT III/III-CPU ignition magneto, CPU95-EVS (DC-DC power supply), for shielded applications up to 6 cylinders	MIL, 7 pole, socket, 90°	48 in	180 in	393013-2
95.30.007-4	2	Output harness for ALT III/III-CPU ignition magneto, CPU95-EVS (DC-DC power supply), for shielded applications up to 6 cylinders	MIL, 7 pole, socket, 90°	20 in	60 in	393013-4, 178788A
95.30.007-5	2	Output harness for ALT III/III-CPU ignition magneto, CPU95-EVS (DC-DC power supply), for shielded applications up to 6 cylinders	MIL, 7 pole, socket, 90°	120 in	300 in	393013-5
95.30.007-8	2	Output harness for ALT III/III-CPU ignition magneto, CPU95-EVS (DC-DC power supply), for shielded applications up to 6 cylinders	MIL, 7 pole, socket, 90°	60 in	72 in	393013-8
95.30.007-9	2	Output harness for ALT III/III-CPU ignition magneto, for shielded applications up to 6 cylinders	MIL, 7 pole, socket, 90°	48 in	240 in	393013-9
95.30.007-10	2	Output harness for ALT III/III-CPU ignition magneto, for shielded applications up to 6 cylinders	MIL, 7 pole, socket, 90°	38 in	72 in	393013-6, 393013-10
95.30.007-12	2	Output harness for ALT III/III-CPU ignition magneto, CPU95-EVS (DC-DC power supply), for shielded applications up to 6 cylinders	MIL, 7 pole, socket, 90°	26 in	48 in	393013-12
95.30.007-13	2	Output harness for ALT III/III-CPU ignition magneto, CPU95-EVS (DC-DC power supply), for shielded applications up to 6 cylinders	MIL, 7 pole, socket, 90°	30 in	48 in	393013-13
95.30.007-14	2	Output harness for ALT III/III-CPU ignition magneto, CPU95-EVS (DC-DC power supply), for shielded applications up to 6 cylinders	MIL, 7 pole, socket, 90°	30 in	80 in	393013-14
95.30.008-1	2	Output harness for ALT III/III-CPU ignition magneto, for shielded applications up to 8 cylinders	MIL, 14 pole, socket, 90°	48 in	180 in	393014-1
95.30.008-2	2	Output harness for ALT III/III-CPU ignition magneto, for shielded applications up to 12 cylinders	MIL, 14 pole, socket, 90°	48 in	180 in	393014-2
95.30.008-3	2	Output harness for ALT III/III-CPU ignition magneto, for shielded applications up to 8 cylinders	MIL, 14 pole, socket, 90°	20 in	42 in	393014-3, 178803
95.30.008-4	2	Output harness for ALT III/III-CPU ignition magneto, for shielded applications up to 12 cylinders	MIL, 14 pole, socket, 90°	48 in	72 in	393014-4, 4W-5466, 208502C
95.30.008-5	2	Output harness for ALT III/III-CPU ignition magneto, for shielded applications up to 8 cylinders	MIL, 14 pole, socket, 90°	120 in	300 in	393014-5
95.30.008-6	2	Output harness for ALT III/III-CPU ignition magneto, for shielded applications up to 12 cylinders	MIL, 14 pole, socket, 90°	120 in	300 in	393014-6
95.30.008-7	2	Output harness for ALT III/III-CPU ignition magneto, for shielded applications up to 8 cylinders	MIL, 14 pole, socket, 90°	48 in	72 in	393014-7, 4W-5468
95.30.008-8	2	Output harness for ALT III/III-CPU ignition magneto, for shielded applications up to 12 cylinders	MIL, 14 pole, socket, 90°	36 in	60 in	393014-8, 178804
95.30.008-9	2	Output harness for ALT III/III-CPU ignition magneto, for shielded applications up to 12 cylinders	MIL, 14 pole, socket, 90°	66 in	96 in	393014-9
95.30.008-10	2	Output harness for ALT III/III-CPU ignition magneto, for shielded applications up to 8 cylinders	MIL, 14 pole, socket, 90°	48 in	60 in	393014-10
95.30.008-11	2	Output harness for ALT III/III-CPU ignition magneto, for shielded applications up to 8 cylinders	MIL, 14 pole, socket, 90°	36 in	60 in	393014-11

## Harnesses for WAUKESHA® VHP Series Gas Engines with ESM

P/N	Figure	Description	Length	Equivalent to
A740749-MOT	3	Harness, crankshaft pickup	45 in	A740749
A740750-MOT	4	Harness, camshaft pickup	43 in	A740750
740744-MOT	5	Harness, electric start	46 in	740744
740753-MOT	6	Harness, ground, left bank to right bank	94 in	740753

# Ignition Coils

## UNSHIELDED

### New MOTORTECH Style

Ignition coils are becoming more and more important in modern, state of the art ignition systems. MOTORTECH offers a series of high performance ignition coils produced in its European facilities which are specially designed for use with newest technologies of MOTORTECH ignitions controllers:

- MOST – MOTORTECH Output Stage Technology of MOTORTECH MIC3/3+, MIC4, MIC5 and MIC6 ignition controllers
- Ideally suited for ignition of alternative fuels such as biogas

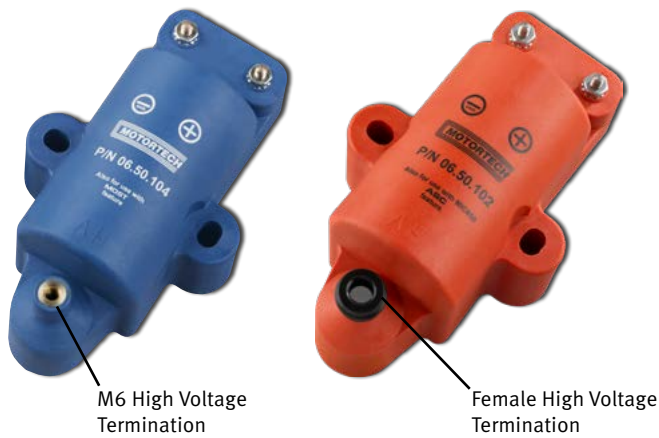

P/N	Color	Primary Termination	HV Termination	Polarity	MOST	Equivalent to
06.50.100	red	#10-32 UNF studs	M6	(-) ground	X (MIC3/3+/4/5)	
06.50.102	red	#10-32 UNF studs	female	(-) ground	X (MIC3/3+/4/5)	
06.50.104 <sup>1)</sup>	blue	#10-32 UNF studs	M6	(-) ground	X (MIC3/3+/4/5/6)	
06.50.105 <sup>1)</sup>	blue	#10-32 UNF studs	female	(-) ground	X (MIC3/3+/4/5/6)	
06.50.112	blue	#10-32 UNF studs	M6	(-) ground	X (MIC3/3+/4/5/6)	
06.50.113	blue	#10-32 UNF studs	female	(-) ground	X (MIC3/3+/4/5/6)	
06.50.300 <sup>2)</sup>	blue	#10-32 UNF studs	M6	(-) ground	X (MIC3/3+)	
06.50.301 <sup>2)</sup>	blue	#10-32 UNF studs	female	(-) ground	X (MIC3/3+)	

<sup>1)</sup> Ignition coils only available as spare parts. <sup>2)</sup> Only for use with MIC3/3+ ignition controllers.

## MOST

MOTORTECH OUTPUT STAGE TECHNOLOGY

**MOST** works with the following principles:

- adjustable ignition spark duration with different available ignition voltages
- constant spark intensity via adjusted ignition spark duration
- 300 to 1000 mJ of primary energy (device dependent) are available

\* Patented Technology US 8,893,692 B2

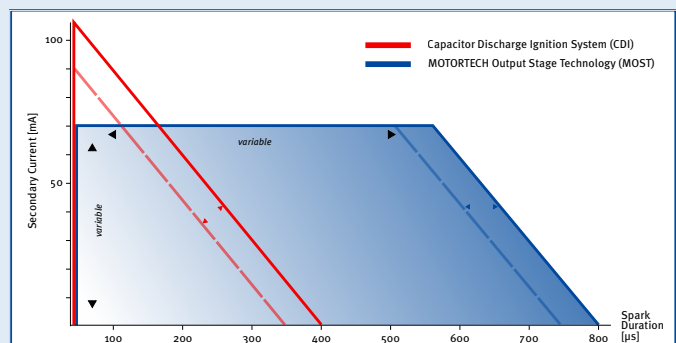

# Ignition Coils



## MOTORTECH Style

Several EPOXY ignition coils with different ignition characteristics are available for unshielded applications. These coils, commonly used with MIC500 and MIC850 or ALTRONIC® CPU95 series ignition controllers, feature a screw type high voltage termination and are designed to function with the appropriate high voltage indication systems.



P/N	Supersedes	Color	Primary Termination	HV Termination	Polarity	MOST	Equivalent to
06.50.003 <sup>1)</sup>	06.50.007	black	#10-32 UNF studs	M6	(-) ground	X (MIC3/3+/4/5)	118257
06.50.060 <sup>2)</sup>		black	#10-32 UNF studs	M6	(-) ground	not applicable	76.64.302

<sup>1)</sup> Also for use with MIC500 and MIC850 ignition controllers.  
<sup>2)</sup> For use with ALTRONIC® CPU95 ignition controllers.

## ALTRONIC® Style

For existing installations with ALTRONIC® ignition coils, MOTORTECH offers a series of replacement products. The ignition coils are designed to have the same characteristics in regards of standard and extended duration as well as the electrical characteristics to function with the ALTRONIC® patented “Spark Reference” high voltage indication system. See chart below for cross reference numbers.



P/N	Color	Primary Termination	HV Termination	Polarity	MOST	Equivalent to
06.50.053	black	#10-32 UNF studs	female	(+) ground	not applicable	291001, 1215 3964
06.50.054	red	#10-32 UNF studs	female	(-) ground	not applicable	591010, Z00-17-001-00, 837/13, 69694B, 4W-5439, 99034
06.50.055	blue	#10-32 UNF studs	female	(-) ground	not applicable	501061, Z00-17-000-00, 837/12, 69694, 2W-3747, 76.64.005, 1215 3965, 99033
06.50.065	black	#10-32 UNF studs	female	(-) ground	X (MIC3/3+/4/5)	

Thousands of smaller gas engines (including CUMMINS®) are equipped with low cost ignition controllers like ALTRONIC® CD1 or CD200 series that use this compact coil. MOTORTECH offers an alternative.



P/N	Color	Primary Termination	HV Termination	Polarity	MOST	Equivalent to
06.50.103	black	#10-32 UNF studs	male	(-) ground	not applicable	591040, 3394578

# Ignition Coils

## UNSHIELDED

### Ignition Coils for CATERPILLAR® Gas Engines

The rising demand for specialized ignition coils has led MOTORTECH to the decision to design a new series of ignition coils, specially made for use with CATERPILLAR® gas engines.

- Compatible with original ignition coils
- Support CATERPILLAR® ignition systems
- Made in Europe



#### For CATERPILLAR® G3400/C & G3500/B/C/E/H Series Gas Engines (Non CSA Applications)

P/N	Color	Primary Termination	HV Termination	Polarity	MOST	Application	Equivalent to
06.50.141	white	DEUTSCH® connector	female	(-) ground	not applicable	G3400/C series, EIS, short cylinder head	437-4049, 232-6348, 165-1591, 131-3277, 129-8802, 108-0615
06.50.145 <sup>1)</sup>	white	DEUTSCH® connector	female	(-) ground	X (MIC3/3+/4/5)	G3400/C series, MIC, short cylinder head	437-4049, 232-6348, 165-1591, 131-3277, 129-8802, 108-0615
06.50.143	white	DEUTSCH® connector	female	(-) ground	not applicable	G3400/C series, EIS, tall cylinder head	232-6352, 213-7443
06.50.147 <sup>1)</sup>	white	DEUTSCH® connector	female	(-) ground	X (MIC3/3+/4/5)	G3400/C series, MIC, tall cylinder head	232-6352, 213-7443
06.50.151	white	DEUTSCH® connector	female	(-) ground	not applicable	G3500 series, EIS	418-4861, 232-6346, 165-1589, 124-0749
06.50.155 <sup>1)</sup>	white	DEUTSCH® connector	female	(-) ground	X (MIC3/3+/4/5)	G3500 series, MIC	418-4861, 232-6346, 165-1589, 124-0749
06.50.153	white	DEUTSCH® connector	female	(-) ground	not applicable	G3500/B series, ADEM	437-4106, 232-6350, 199-9011
06.50.157 <sup>1)</sup>	white	DEUTSCH® connector	female	(-) ground	X (MIC3/3+/4/5)	G3500/B series, MIC	437-4106, 232-6350, 199-9011
06.50.159	white	DEUTSCH® connector	female	(-) ground	not applicable	G3500C/E/H series, ADEM	356-3701
06.50.160 <sup>1)</sup>	white	DEUTSCH® connector	female	(-) ground	X	G3500C/E/H series, MIC	356-3701

<sup>1)</sup> Only for use with MIC3/3+, MIC4 and MIC5 ignition controllers.

#### For CATERPILLAR® G3400/C & G3500/B Series Gas Engines (CSA Applications)

P/N	Color	Primary Termination	HV Termination	Polarity	MOST	Application	Equivalent to
06.50.142	white	DEUTSCH® connector	female	(-) ground	not applicable	G3400/C series, EIS, short cylinder head	232-6349, 165-1592, 122-8070
06.50.146 <sup>1)</sup>	white	DEUTSCH® connector	female	(-) ground	X (MIC3/3+/4/5)	G3400/C series, MIC, short cylinder head	232-6349, 165-1592, 122-8070
06.50.144	white	DEUTSCH® connector	female	(-) ground	not applicable	G3400/C series, EIS, tall cylinder head	232-6353, 213-7444
06.50.148 <sup>1)</sup>	white	DEUTSCH® connector	female	(-) ground	X (MIC3/3+/4/5)	G3400/C series, MIC, tall cylinder head	232-6353, 213-7444
06.50.152	white	DEUTSCH® connector	female	(-) ground	not applicable	G3500 series, EIS	437-4047, 232-6347, 165-1590
06.50.156 <sup>1)</sup>	white	DEUTSCH® connector	female	(-) ground	X (MIC3/3+/4/5)	G3500 series, MIC	437-4047, 232-6347, 165-1590
06.50.154	white	DEUTSCH® connector	female	(-) ground	not applicable	G3500/B series, ADEM	418-4862, 259-2078
06.50.158 <sup>1)</sup>	white	DEUTSCH® connector	female	(-) ground	X (MIC3/3+/4/5)	G3500/B series, MIC	418-4862, 259-2078

<sup>1)</sup> Only for use with MIC3/3+, MIC4 and MIC5 ignition controllers.

Please see pages 38 and 100 for suitable ignition coil extensions and extension overhaul kits.



## For CATERPILLAR® G3500C/E & G3600 Series Gas Engines with Ignition Coil Extension

P/N	Figure	Supersedes	Color	Primary Termination	HV Termination	Polarity	MOST	Application	Equivalent to
06.50.164	<b>1</b>	06.50.161	white	MIL, 3 pole, pin	female	(-) ground	not applicable	G3500C/E, G3600 series, ADEM	438-5682, 310-3180, 283-5269, 232-6351, 191-9346
06.50.165 <sup>1)</sup>	<b>1</b>	06.50.162	white	MIL, 3 pole, pin	female	(-) ground	X	G3500C/E, G3600 series, MIC	438-5682, 310-3180, 283-5269, 232-6351, 191-9346

<sup>1)</sup> Only for use with MIC3/3+, MIC4 and MIC5 ignition controllers.

## For CATERPILLAR® GCM34 Series Gas Engines with Ignition Coil Extension

P/N	Figure	Supersedes	Color	Primary Termination	HV Termination	Polarity	MOST	Application	Equivalent to
06.50.174	<b>2</b>	06.50.170	white	MIL, 3 pole, pin	female	(-) ground	not applicable		193-468157, 258-4893
06.50.175 <sup>1)</sup>	<b>2</b>		white	MIL, 3 pole, pin	female	(-) ground	X		193-468157, 258-4893

<sup>1)</sup> Only for use with MIC3/3+, MIC4 and MIC5 ignition controllers.

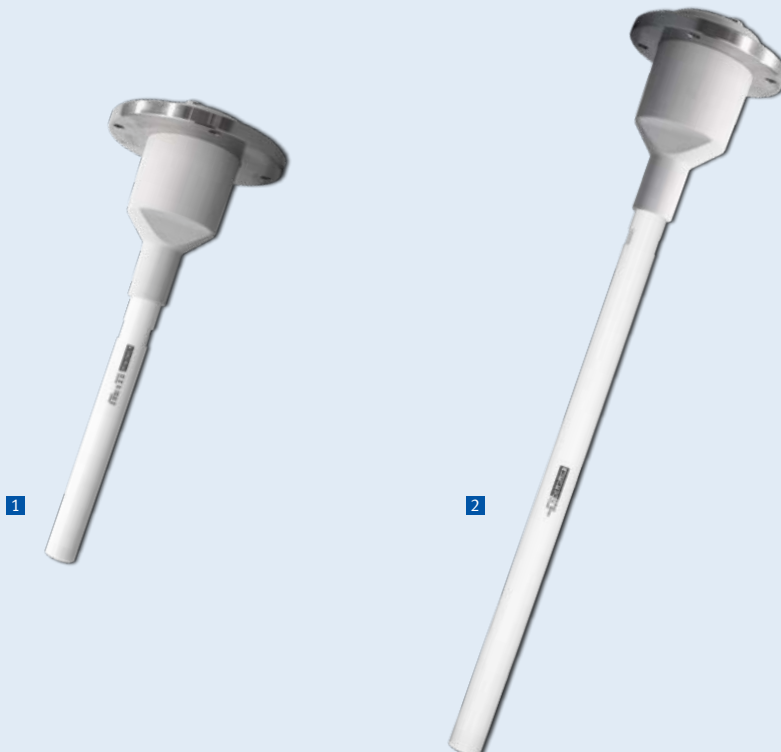



# Ignition Coils

**UNSHIELDED**

## Ignition Coil for WÄRTSILÄ® Gas Engines



For WÄRTSILÄ® 25SG, 28SG and 220G/SG Gas Engines

P/N	Color	Primary Termination	HV Termination	Polarity	MOST	Equivalent to
06.50.059	black	2 pole, pin	female	(-) ground	not applicable	1469-008

**NEW**

## Ignition Coil Conversion Kits for CUMMINS® QSK60G and QSV91G Gas Engines

Many operators of CUMMINS® motors are regularly confronted with a problem. The ignition coils installed by the engine manufacturer wear out quickly and must be replaced at an early stage. Especially the ignition coil extension made of plastic and its insert can break during operation and lead to engine failure. The various conversion kits can be used to solve this problem in the long run. The conversion kits P/N 75.30.156 and P/N 75.30.157 are equipped with a standard ignition coil mounted on a metal plate on the engine's valve cover. A PolyMot™ spark plug lead connects ignition coil and spark plug. With the included primary lead, the ignition coil is simply connected to the existing engine wiring. Due to the modular design of the conversion kits, all components can be replaced individually if necessary, thus reducing the operating costs of the engine.



### Features

- Easy and fast conversion (plug & play) of existing OEM ignition coil
- Use of long-lasting components
- Components available individually if required
- Cost effective solution

P/N	Description	Quantity	Equivalent to
75.30.156	Ignition coil conversion kit for CUMMINS® QSK60G <i>Contains:</i> <ul style="list-style-type: none"> <li>■ Ignition coil</li> <li>■ Primary lead with connector (3 pole, socket) for connection to engine wiring</li> <li>■ Ignition coil mounting plate with fastening material</li> <li>■ PolyMot™ spark plug lead</li> </ul>	1 pc 1 pc 1 pc 1 pc	2881124, 4011615, 11.371
75.30.157	Ignition coil conversion kit for CUMMINS® QSV91G <i>Contains:</i> <ul style="list-style-type: none"> <li>■ Ignition coil</li> <li>■ Primary lead with connector (3 pole, socket) for connection to engine wiring</li> <li>■ Ignition coil mounting plate with fastening material</li> <li>■ PolyMot™ spark plug lead</li> </ul>	1 pc 1 pc 1 pc 1 pc	2881124, 4011615, 11.020

## Ignition Coil Conversion Kits for CUMMINS® & WÄRTSILÄ® Gas Engines

As an alternative to the simple variants, ignition coil conversion kits are available, which additionally enable professional monitoring of the high voltage during engine operation at each ignition coil. These conversion kits are equipped with MOTORTECH flange ignition coils with diagnostic interface and integrated primary lead as well as PolyMot™ spark plug extensions and also enable easy and fast retrofitting.

### Features

- For CUMMINS® QSK60G and QSV81G/ QSV91G and WÄRTSILÄ® 28SG and 34SG series gas engines
- Easy and fast conversion (plug & play) of existing OEM ignition coil
- Use of long-lasting components
- Components available individually if required
- For unshielded applications (non CSA)
- Professional solution

### 1 Ignition Coil

- MOTORTECH ignition coil with specific flange
- Diagnostic interface (BNC connector) for easy monitoring of high voltage traces via MOTORTECH SparkView or digital oscilloscope
- Pressure proof metal housing

### 2 Adaptor Flange

### 3 Engine specific PolyMot™ Spark Plug Extension

- High quality Teflon® for long life
- Built in 5 kOhm resistor for EMI suppression
- Integrated silicone seal ring for best flashover protection
- Special top thread for easy removal with MOTORTECH removal tool (P/N 44.99.912)

### 4 Fastening Material



Ignition Coil for WÄRTSILÄ Gas Engines | Ignition Coil Conversion Kits

P/N	Description	Quantity	Equivalent to
75.30.143	Ignition coil conversion kit for CUMMINS® QSK60G <i>Contains:</i> <ul style="list-style-type: none"> <li>■ Flange ignition coil with diagnostic interface and integrated primary lead</li> <li>■ Adaptor flange with fastening material</li> <li>■ PolyMot™ spark plug extension</li> </ul>	1 pc 1 pc 1 pc	2881124, 4011615
75.30.144	Ignition coil conversion kit for CUMMINS® QSV81G/QSV91G <i>Contains:</i> <ul style="list-style-type: none"> <li>■ Flange ignition coil with diagnostic interface and integrated primary lead</li> <li>■ Adaptor flange with fastening material</li> <li>■ PolyMot™ spark plug extension</li> </ul>	1 pc 1 pc 1 pc	2881124, 4011615
75.30.154	Ignition coil conversion kit for WÄRTSILÄ® 28SG series <i>Contains:</i> <ul style="list-style-type: none"> <li>■ Flange ignition coil with diagnostic interface and integrated primary lead</li> <li>■ Adaptor flange with fastening material</li> <li>■ PolyMot™ spark plug extension</li> </ul>	1 pc 1 pc 1 pc	2313-011
75.30.155	Ignition coil conversion kit for WÄRTSILÄ® 34SG series <i>Contains:</i> <ul style="list-style-type: none"> <li>■ Flange ignition coil with diagnostic interface and integrated primary lead</li> <li>■ Adaptor flange with fastening material</li> <li>■ PolyMot™ spark plug extension</li> </ul>	1 pc 1 pc 1 pc	120095 (18V34SG) 120096 (20V34SG)

# Ignition Coils

## Ignition Coil Extensions

For **MOTORTECH/CATERPILLAR®** Ignition Coils – For **CATERPILLAR®** G3500C/E and G3600 Series Gas Engines

P/N	Figure	Description	Application	Resistance	Teflon® Insulator		Fits Ignition Coil P/N	Equivalent to
					Length	Diameter		
06.80.459H <sup>1)</sup>	1	Ignition coil extension	G3500C/E, G3600	0 kΩ	248 mm	26 mm	06.50.161, 06.50.162, 283-5270	308-1380, 283-5271, 264-5323, 150-2050
06.80.600	2	Ignition coil extension	G3500C/E, G3600	0 kΩ	252 mm	26 mm	06.50.164, 06.50.165	

<sup>1)</sup> Supersedes ignition coil extensions P/N 06.80.375H and 06.80.446H.

For **MOTORTECH/CATERPILLAR®** Ignition Coils – For **CATERPILLAR®** GCM34 Series Gas Engines

P/N	Figure	Description	Application	Resistance	Teflon® Insulator		Fits Ignition Coil P/N	Equivalent to
					Length	Diameter		
06.80.1013-T	3	Ignition coil extension	GCM34	5 kΩ	530 mm	26 mm	193-468157, 258-4893, 06.50.170	263210167, 3400.7-21.07.02-03
06.80.602	4	Ignition coil extension	GCM34	5 kΩ	534 mm	26 mm	06.50.174, 06.50.175	

For **WÄRTSILÄ®** 34SG Series Gas Engines

P/N	Description	Application	Resistance	Teflon® Insulator		Fits Ignition Coil P/N	Equivalent to
				Length	Diameter		
06.80.460	Ignition coil extension	34SG series	5 kΩ	460 mm	26 mm		0012E002200
06.80.461	Ignition coil extension	34SG series	5 kΩ	446 mm	26 mm		0012E006500

Please consult factory for availability of ignition coil extensions for 220G/SG series gas engines (P/N 3340063 and 3341380)



## Ignition Coil Extension Overhaul Kits

Kits for **MOTORTECH** Ignition Coils – For **CATERPILLAR**® G3400/C and G3500/B/C/E/H Series Gas Engines

P/N	Figure	Supersedes	Description	Application	Teflon® Insulator		Fits Ignition Coil P/N
					Length	Diameter	
06.80.741	5		Extension overhaul kit	G3400 – Non CSA	95 mm	30 mm	06.50.141, 06.50.145
06.80.742	5		Extension overhaul kit	G3400 – CSA	97 mm	30 mm	06.50.142, 06.50.146
06.80.743	5		Extension overhaul kit	G3400 – Non CSA	107 mm	30 mm	06.50.143, 06.50.147
06.80.744	5		Extension overhaul kit	G3400 – CSA	109 mm	30 mm	06.50.144, 06.50.148
06.80.751	5		Extension overhaul kit	G3500 – Non CSA	118 mm	30 mm	06.50.151, 06.50.155
06.80.752	5		Extension overhaul kit	G3500 – CSA	105 mm	30 mm	06.50.152, 06.50.156
06.80.753	5		Extension overhaul kit	G3500 – Non CSA	112 mm	30 mm	06.50.153, 06.50.157
06.80.754	5		Extension overhaul kit	G3500 – CSA	105 mm	30 mm	06.50.154, 06.50.158
06.80.764	5		Extension overhaul kit	G3500 – Non CSA	104 mm	25 mm	06.50.159, 06.50.160

Kits for **CATERPILLAR**® Ignition Coils – For **CATERPILLAR**® G3400/C and G3500/B Series Gas Engines

P/N	Figure	Supersedes	Description	Application	Teflon® Insulator		Fits Ignition Coil P/N
					Length	Diameter	
06.80.419H	5		Extension overhaul kit	G3400 – Non CSA	95 mm	30 mm	232-6348, 165-1591, 131-3277, 129-8802, 108-0615
06.80.742	5	06.80.418H	Extension overhaul kit	G3400 – CSA	97 mm	30 mm	232-6349, 165-1592, 122-8070
06.80.420H	5		Extension overhaul kit	G3400 – Non CSA	107 mm	30 mm	232-6352, 213-7443
06.80.744	5	06.80.417H	Extension overhaul kit	G3400 – CSA	109 mm	30 mm	232-6353, 213-7444
06.80.515H	5	06.80.315H	Extension overhaul kit	G3500 – Non CSA	118 mm	30 mm	232-6346, 165-1589, 124-0749
06.80.752	5	06.80.415H	Extension overhaul kit	G3500 – CSA	105 mm	30 mm	232-6347, 165-1590
06.80.480	5		Extension overhaul kit	G3500 – Non CSA	112 mm	30 mm	232-6350
06.80.754	5	06.80.415H	Extension overhaul kit	G3500 – CSA	105 mm	30 mm	259-2078



5

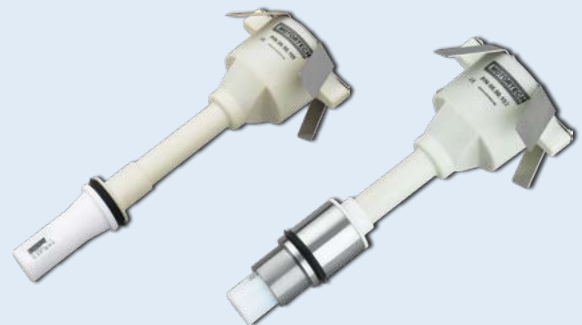

# Ignition Coils

## UNSHIELDED

### Accessories for Unshielded Ignition Coils

Different ignition coil styles require different boots to seal the primary or secondary terminals. MOTORTECH boots are all made from highest grade of silicone (482 °F/ 250 °C).

The boots will remain soft and flexible over a long time and protect the operator from touching any low or high voltage terminations. The boots also ensure that the critical areas stay clean and dry even in the worst environment.

#### Boots for MOTORTECH Ignition Coils

P/N	Figure	Ignition Coil Side		Outlet		Ignition Coil 06.50. ...															
		Primary	Secondary	90 °	180 °	003	053	054	055	060	065	100	102	103	104	105	112	113	300	301	
06.80.037	1	x		x		x	x	x	x	x	x										
06.84.082	2	x		x								x	x		x	x	x	x	x	x	x
06.84.021	3	x		x										x <sup>1)</sup>							
06.80.005	4	x			x	x	x	x	x	x	x										
06.84.083	5		x	x								x			x		x			x	
06.80.006	6		x		x	x				x											
06.84.006	7		x		x		x	x	x		x		x			x		x			x

<sup>1)</sup> Two boots needed for each ignition coil.



#### Boots for ALTRONIC® Ignition Coils

P/N	Figure	Ignition Coil Side		Outlet		Ignition Coil
		Primary	Secondary	90 °	180 °	
06.80.037	1	x		x		291001, 591010, 501061
06.80.036	2	x			x	291001, 591010, 501061
06.84.006	3		x		x	291001, 591010, 501061



## Secondary Connections

P/N	Figure	Description	Ignition Coil 06.50. ...														
			003	053	054	055	060	065	100	102	103	104	105	112	113	300	301
06.80.261	1	Coil terminal, 180°, requires P/N 06.80.126		x	x	x		x		x			x		x		x
06.80.091	2	Coil terminal, 180°, requires P/N 06.80.126							x <sup>1)</sup>		x	x <sup>1)</sup>		x <sup>1)</sup>		x <sup>1)</sup>	
06.80.108	3	Crimp terminal base	x				x	x			x		x		x		
06.80.116	4	Crimp terminal, 90°, requires P/N 06.80.108	x				x										
06.80.116-180	5	Crimp terminal, 180°, requires P/N 06.80.108						x			x		x		x		
06.80.126	6	Crimp terminal base		x	x	x		x	x <sup>1)</sup>	x	x	x <sup>1)</sup>	x	x <sup>1)</sup>	x	x <sup>1)</sup>	x
06.84.024	7	Coil terminal, 90°, including terminal P/N 02.85.920									x						
06.84.025	8	Coil terminal, 180°, including terminal P/N 02.85.920									x						
22.80.009	9	Coil terminal, 90°, 1 kΩ resistor, requires P/N 06.80.126								x			x		x		x

<sup>1)</sup> When using SAE contact pin P/N 06.51.223.



## Accessories

P/N	Figure	Description	Ignition Coil 06.50. ...														
			003	053	054	055	060	065	100	102	103	104	105	112	113	300	301
06.51.223	1	SAE contact pin							x			x		x		x	
06.90.264 <sup>1)</sup>	2	Accessory kit incl. fastening screws and nuts							x	x		x	x	x	x	x	x
02.85.1012	3	SAE spreading adaptor		x	x	x		x		x		x		x			x

<sup>1)</sup> Comes with each New MOTORTECH Style ignition coil.





# Ignition Coils

**SHIELDED**

## Flange Ignition Coils

MOTORTECH makes available the BLUE and RED flanged ignition coil as a replacement for the existing products sold by ALTRONIC® and the engine manufacturers.

A specially designed version for use with newest technologies of MOTORTECH ignitions controllers is also available:

- MOST – MOTORTECH Output Stage Technology of MOTORTECH MIC3/3+, MIC4, MIC5 and MIC6 ignition controllers



### 3 Pole Primary Connector Arrangement



P/N	Supersedes	Color	Primary Termination	HV Termination	Polarity	MOST	Equivalent to
06.50.034	95.09.134	red	MIL, 3 pole, pin	female	(-) ground	not applicable	591012, 69694F, 7W-4377
06.50.035	95.09.135	blue	MIL, 3 pole, pin	female	(-) ground	not applicable	591018, 69694G, A69694G
06.50.036	95.09.100	red	MIL, 3 pole, pin	female	(-) ground	x	

# Ignition Coils



## Flange Ignition Coils with integrated Primary Lead

Based on its known flange ignition coils, MOTORTECH offers a series with integrated primary leads. Different configurations with 2-pole and 3-pole connectors in 90° and 180° are available to connect the ignition coil directly to a wiring rail or to replace OEM products in the field.



SHIELDED



### 2 Pole Primary Connector Arrangement – For use with AlphaRail Wiring Rails



P/N <sup>1)</sup>	Figure	Color	Wiring Rail Connector	HV Termination	Polarity	MOST	Equivalent to
06.50.034-L-C	1	red	MIL, 2 pole, pin, 180°	female	(-) ground	not applicable	
06.50.034-L-D	2	red	MIL, 2 pole, pin, 90°	female	(-) ground	not applicable	
06.50.035-L-C	1	blue	MIL, 2 pole, pin, 180°	female	(-) ground	not applicable	
06.50.035-L-D	2	blue	MIL, 2 pole, pin, 90°	female	(-) ground	not applicable	
06.50.036-L-C	1	red	MIL, 2 pole, pin, 180°	female	(-) ground	X	
06.50.036-L-D	2	red	MIL, 2 pole, pin, 90°	female	(-) ground	X	

<sup>1)</sup> Standard primary lead lengths (-L) = 12 in, 18 in, 24 in, 30 in, 36 in, 42 in. Other lengths available on request.

### For use with WAUKESHA® ESM Gas Engines



P/N	Figure	Color	Primary Lead Length	Wiring Rail Connector	HV Termination	Polarity	MOST	Equivalent to
06.50.035-36-E	3	blue	36 in	MIL, 3 pole, pin, 180°	female	(-) ground	not applicable	69957, 69957A



# Ignition Coils

**SHIELDED**



## Flange Ignition Coils with Diagnostic Interface

These MOTORTECH ignition coils are designed for operators who want to monitor their high voltage traces in a simple way. Measuring high voltage peak (kV) and spark duration ( $\mu\text{sec}$ ) of all cylinders of an engine with flange ignition coils regularly, will allow easy maintenance of the equipment.

With a MOTORTECH SparkView or digital Scope Meter the operator can receive real time data.



### 3 Pole Primary Connector Arrangement



P/N	Color	Primary Termination	HV Termination	Polarity	MOST	Equivalent to
95.09.150 <sup>1)</sup>	steel	MIL, 3 pole, pin	female	(-) ground	X (MIC3/3+/4/5)	06.50.036, 95.09.100
95.09.153 <sup>2)</sup>	steel	MIL, 3 pole, pin	female	(+) ground	not applicable	95.09.133
95.09.154 <sup>3)</sup>	steel	MIL, 3 pole, pin	female	(-) ground	not applicable	06.50.034, 95.09.134
95.09.155 <sup>4)</sup>	steel	MIL, 3 pole, pin	female	(-) ground	not applicable	06.50.035, 95.09.135

<sup>1)</sup> Same coil winding as P/N 06.50.036 and 95.09.100, but with diagnostic interface.

<sup>2)</sup> Same coil winding as P/N 95.09.133, but with diagnostic interface.

<sup>3)</sup> Same coil winding as P/N 06.50.034 and 95.09.134, but with diagnostic interface. Thus also equivalent to P/N 591012, 69694F and 7W-4377.

<sup>4)</sup> Same coil winding as P/N 06.50.035 and 95.09.135, but with diagnostic interface. Thus also equivalent to P/N 591018, 69694G and A69694G.



Additional BNC connector for high voltage measurement

## SparkView

MOTORTECH HIGH VOLTAGE INDICATOR

The SparkView is a handheld device developed by MOTORTECH that can monitor the high voltage required by the spark plug while the engine is running. With a measuring clamp or cable and the display for up to 40 kV, it is easy to determine the condition of the spark plugs and the time at which they need to be replaced.



See page 120.

# Ignition Coils



## Flange Ignition Coils with Diagnostic Interface and integrated Primary Lead

MOTORTECH flange ignition coils with diagnostic interface are also available with integrated primary leads. These include different connector arrangements for a direct wiring rail connection and to offer an upgrade and replacement to used OEM products.



### 2 Pole Primary Connector Arrangement – For use with AlphaRail Wiring Rails



P/N <sup>1)</sup>	Figure	Color	Wiring Rail Connector	HV Termination	Polarity	MOST	Equivalent to
95.09.150-L-C	1	steel	MIL, 2 pole, pin, 180°	female	(-) ground	X (MIC3/3+/4/5)	
95.09.150-L-D	2	steel	MIL, 2 pole, pin, 90°	female	(-) ground	X (MIC3/3+/4/5)	
95.09.154-L-C	1	steel	MIL, 2 pole, pin, 180°	female	(-) ground	not applicable	
95.09.154-L-D	2	steel	MIL, 2 pole, pin, 90°	female	(-) ground	not applicable	
95.09.155-L-C	1	steel	MIL, 2 pole, pin, 180°	female	(-) ground	not applicable	
95.09.155-L-D	2	steel	MIL, 2 pole, pin, 90°	female	(-) ground	not applicable	

<sup>1)</sup> Standard primary lead lengths (-L) = 12 in, 18 in, 24 in, 30 in, 36 in, 42 in. Other lengths available on request.

### For use with WAUKESHA® ESM Gas Engines



P/N	Figure	Color	Primary Lead Length	Wiring Rail Connector	HV Termination	Polarity	MOST	Equivalent to
95.09.155-36-E <sup>1)</sup>	3	steel	36 in	MIL, 3 pole, pin, 180°	female	(-) ground	not applicable	06.50.035-36-E

<sup>1)</sup> Same coil winding as P/N 06.50.035-36-E, but with diagnostic interface. Thus also equivalent to P/N 69957 and 69957A.

### For use with CUMMINS® and WÄRTSILÄ® Gas Engines

P/N	Figure	Color	Primary Lead Length	Wiring Rail Connector	HV Termination	Polarity	MOST	Equivalent to
95.09.156-20-B <sup>1)</sup>		steel	20 in	3 pole, socket, 180°	female	(-) ground	X (MIC3/3+/4/5)	
95.09.157-28-G <sup>2)</sup>	4	steel	28 in	MIL, 5 pole, pin, 180°	female	(-) ground	X (MIC3/3+/4/5)	

<sup>1)</sup> Use of ignition coil only possible, if conversion kits P/N 75.30.143 (CUMMINS® QSK60G) or 75.30.144 (CUMMINS® QSV81/91G) previously were used.

<sup>2)</sup> Use of ignition coil only possible, if conversion kits P/N 75.30.154 (WÄRTSILÄ® 28SG) or 75.30.155 (WÄRTSILÄ® 34SG) previously were used.



## Ignition Coils

### Spark Plug Carrier and Flange Adaptor Hardware Kit for **WAUKESHA**® VHP-GL Engines – CSA® Conversion

- For modification of standard ignition coil to flange ignition coil arrangement
- Available as single parts
- Stock item

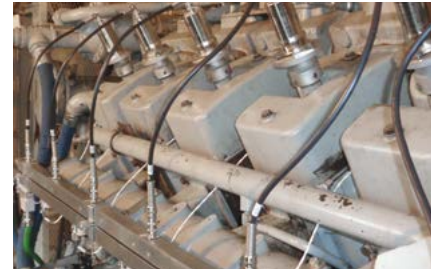

#### A Primary Lead

P/N	Description	Equivalent to	Required Qty per Cylinder
95.01.020-30	Primary lead, Conventional Style, 3 pole ignition coil connector, 1/2-14 NPT junction box adaptor	208503K, 593027-30	1
alternative 95.01.120-30	Primary lead, New Flex Style, 3 pole ignition coil connector, 1/2-14 NPT junction box adaptor	95.01.020-30	1

#### B Flange Ignition Coil

P/N	Description	Equivalent to	Required Qty per Cylinder
06.50.035	Flange ignition coil	A69694G, 69694G, 591018	1
alternative 95.09.155 <sup>1)</sup>	Flange ignition coil with diagnostic interface	06.50.035	1

<sup>1)</sup> Same coil winding as P/N 06.50.035, but with diagnostic interface. Thus also equivalent to P/N 591018 and 69694G, A69694G.

#### C PolyMot™ Spark Plug Extension

P/N	Description	Equivalent to	Required Qty per Cylinder
06.80.321-T	PolyMot™ spark plug extension	A211797H, A211797P, 211357P, 211357U, A211797R	1

#### D Spark Plug

P/N	Description	Equivalent to	Required Qty per Cylinder
FB77WPCC	CHAMPION® spark plug, M18x1.5, reach 0.750 in, J-type Ir/Pt, HEX 7/8 in (22.2 mm)	69919, 60999T	1
alternative B8324	MOTORTECH MHP spark plug, M18x1.5, reach 0.750 in, J-type Ir/Ir, HEX 13/16 in (20.8 mm)		1
alternative G13-3	DENSO® spark plug, M18x1.5, reach 0.750 in, J-type Ir/Pt, HEX 7/8 in (22.2 mm)		1

**SparkView**  
MOTORTECH HIGH VOLTAGE INDICATOR

The SparkView is a handheld device developed by MOTORTECH that can monitor the high voltage required by the spark plug while the engine is running. With a measuring clamp or cable and the display for up to 40 kV, it is easy to determine the condition of the spark plugs and the time at which they need to be replaced.



# Ignition Coils



A



B



C



D



E



F



## E Adaptor for Flange Ignition Coil/Spark Plug Carrier

P/N	Description	Equivalent to	Required Qty per Cylinder
211749-MOT	Adaptor for flange ignition coil/spark plug carrier	211749	1

**NOTE:** Screws and washers for fastening of flange ignition coil not included. Hex head screws (3 pcs 5/16-18x3/4 in – WED P/N 21309) and washers (3 pcs 5/16 in – WED P/N 21051) have to be supplied by customer.

## F Spark Plug Carrier

P/N	Description	Equivalent to	Required Qty per Cylinder
209567R-MOT	Spark plug carrier	209567R	1

**NOTE:** Screws and washers for fastening of flange adaptor not included. Hex head screws (4 pcs 1/4-28x1/2 in – WED P/N 21296) and lock washers (4 pcs 1/4 in – WED P/N 21050) have to be supplied by customer.

## Optional Tools

### Installation Tool for Spark Plug Carrier

P/N	Description
44.01.015	Installation tool for spark plug carrier

### Spare Part for Installation Tool

P/N	Description
44.01.017	Feather key for installation tool

### Extended Barrel Magnetic Spark Plug Sockets

P/N	Description
07.99.022-3-18	Magnetic spark plug socket, HEX 7/8 in (22.2 mm), 1/2 in drive, length 18 in (457.2 mm), for use with spark plugs P/N 69919, 60999T, FB77WPCC, G13-3
07.99.022-4-18	Magnetic spark plug socket, HEX 13/16 in (20.8 mm), 1/2 in drive, length 18 in (457.2 mm), for use with spark plug P/N B8324

### SparkView – High Voltage Indicator

P/N	Description
06.90.099-105	SparkView high voltage indicator – incl. BNC cable P/N 06.90.105, for use with flange ignition coils with diagnostic interface



# Ignition Coils

## SHIELDED

### Externally Mounted Ignition Coils

Shielded – externally mounted – ignition coils are encapsulated in a steel housing with welded lids. A bracket is used to install the ignition coils on a wiring rail or directly on the engine. This type of ignition coil is connected to the spark plug by a shielded spark plug lead with a 3/4 in or 1 in termination. Primary voltage connection is made by a 2 or 3 pole military style screw connector. All parts meet the CSA Class I, Division 2, Group C/D.



### 3 Pole Primary Connector Arrangement



P/N	Supersedes	Color	Primary Termination	HV Termination	Polarity	MOST	Equivalent to
95.09.005		steel	MIL, 3 pole, pin	3/4-20 UNEF	(-) ground	X (MIC3/3+/4/5/6)	
95.09.053	95.09.001	steel	MIL, 3 pole, pin	3/4-20 UNEF	(+) ground	not applicable	291001-S, R65431A
95.09.054	95.09.003	steel	MIL, 3 pole, pin	3/4-20 UNEF	(-) ground	not applicable	591010-S
95.09.055	95.09.002	steel	MIL, 3 pole, pin	3/4-20 UNEF	(-) ground	not applicable	501061-S, 2881178, 701501, 028-989-001

### 2 Pole Primary Connector Arrangement



P/N	Supersedes	Color	Primary Termination	HV Termination	Polarity	MOST	Equivalent to
95.08.003	95.08.001, 95.08.002	steel	MIL, 2 pole, pin	1-20 UNEF	(-) ground	X	PPT2477AD, PPT2477AD-L
95.08.005		steel	MIL, 2 pole, pin	3/4-20 UNEF	(+) ground	not applicable	10-382040-1

# Ignition Coils



## Externally Mounted Ignition Coils with Diagnostic Interface

These MOTORTECH ignition coils are designed for operators who want to monitor their high voltage traces in a simple way. Measuring high voltage peak (kV) and spark duration (µsec) of all cylinders of an engine with externally mounted ignition coils regularly, will allow easy maintenance of the equipment.

With a MOTORTECH SparkView or digital Scope Meter the operator can receive real time data.



### 3 Pole Primary Connector Arrangement

P/N	Supersedes	Color	Primary Termination	HV Termination	Polarity	MOST	Equivalent to
95.09.070 <sup>1)</sup>		steel	MIL, 3 pole, pin	3/4-20 UNEF	(-) ground	X	95.09.005
95.09.073 <sup>2)</sup>		steel	MIL, 3 pole, pin	3/4-20 UNEF	(+) ground	not applicable	95.09.053
95.09.074 <sup>3)</sup>		steel	MIL, 3 pole, pin	3/4-20 UNEF	(-) ground	not applicable	95.09.054
95.09.075 <sup>4)</sup>		steel	MIL, 3 pole, pin	3/4-20 UNEF	(-) ground	not applicable	95.09.055

<sup>1)</sup> Same coil winding as P/N 95.09.005, but with diagnostic interface.

<sup>2)</sup> Same coil winding as P/N 95.09.053, but with diagnostic interface. Thus also equivalent to P/N 291001-S and R65431A.

<sup>3)</sup> Same coil winding as P/N 95.09.054, but with diagnostic interface. Thus also equivalent to P/N 591010-S.

<sup>4)</sup> Same coil winding as P/N 95.09.055, but with diagnostic interface. Thus also equivalent to P/N 501061-S, 2881178, 701501 and 028-989-001.

### 2 Pole Primary Connector Arrangement

P/N	Supersedes	Color	Primary Termination	HV Termination	Polarity	MOST	Equivalent to
95.08.070 <sup>1)</sup>		steel	MIL, 2 pole, pin	1-20 UNEF	(-) ground	X	95.08.003

<sup>1)</sup> Same coil winding as P/N 95.08.003, but with diagnostic interface. Thus also equivalent to P/N PPT2477AD and PPT2477AD-L.



Additional BNC connector for high voltage measurement

## SparkView

MOTORTECH HIGH VOLTAGE INDICATOR

The SparkView is a handheld device developed by MOTORTECH that can monitor the high voltage required by the spark plug while the engine is running. With a measuring clamp or cable and the display for up to 40 kV, it is easy to determine the condition of the spark plugs and the time at which they need to be replaced.



See page 120.

# Ignition Coils

**SHIELDED**

## Integral Ignition Coils – Slim Design

Integral ignition coils are mostly used in shielded applications and are designed to be mounted directly on a dual threaded spark plug. This design does not require a spark plug lead. The ignition coil life is affected by the temperature that is transferred into the coil by the spark plug. On occasions where the spark plug leaks, high combustion pressure enters the ignition coil and forces the base coil to blow out of its housing. MOTORTECH's design with a new top cover and a modern production process will not allow this to happen.

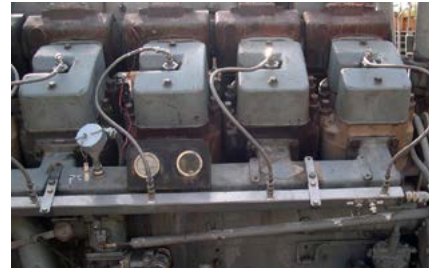

Top cover with integrated HEX for easy installation/deinstallation



### 3 Pole Primary Connector Arrangement – ALTRONIC®, MIC3/3+, MIC4 Compatible – MOST



P/N <sup>1)</sup>	Supersedes	Color	Length	Primary Termination	HV Termination		Polarity	MOST	Equivalent to
					Outer Thread	Inner Thread			
95.09.222-6 <sup>2)</sup>	95.09.012-6, 95.09.040-6, 95.09.022-6	steel	6.00 in	MIL, 3 pole, pin		13/16-20 UNEF	(-) ground	X (MIC3/3+/4)	591011A, 107-2400
95.09.222-12 <sup>2)</sup>	95.09.012-12, 95.09.040-12, 95.09.022-12	steel	12.00 in	MIL, 3 pole, pin		13/16-20 UNEF	(-) ground	X (MIC3/3+/4)	591011B, 591011C, 215-2434, 69694D
95.09.223-6 <sup>2)</sup>	95.09.010, 95.09.030, 95.09.023-6	steel	6.00 in	MIL, 3 pole, pin	1-20 UNEF	13/16-20 UNEF	(-) ground	not applicable	591007, 4W-4959, 60615F
95.09.233-6 <sup>3)</sup>	95.09.011, 95.09.031, 95.09.033-6	steel	6.00 in	MIL, 3 pole, pin	1-20 UNEF	13/16-20 UNEF	(+) ground	not applicable	591008

<sup>1)</sup> Ignition coils in 10 in. only available on special request.

<sup>2)</sup> For use with MIC500, MIC3/3+, MIC4, ALT I, ALT III, ALT V, CD200, CD200D, DISN, CPU90, CPU95, CEC, CATERPILLAR® (163-6164, 163-6108).

<sup>3)</sup> For use with ALT II, DIS, CPU2000.

### 2 Pole Primary Connector Arrangement – FAIRBANKS MORSE® Style



P/N <sup>1)</sup>	Supersedes	Color	Length	Primary Termination	HV Termination		Polarity	MOST	Equivalent to
					Outer Thread	Inner Thread			
95.08.222-6 <sup>2)</sup>	95.08.010-6, 95.08.030-6, 95.08.022-6	steel	6.00 in	MIL, 2 pole, pin		13/16-20 UNEF	(-) ground	X (MIC3/3+/4)	PPT2477AA-6
95.08.222-12 <sup>2)</sup>	95.08.010-12, 95.08.030-12, 95.08.022-12	steel	12.00 in	MIL, 2 pole, pin		13/16-20 UNEF	(-) ground	X (MIC3/3+/4)	PPT2477AA-12

<sup>1)</sup> Ignition coils in 8 in (PPT2477AA-8) and 10 in (PPT2477AA-10) only available on special request.

<sup>2)</sup> For use with MIC3/3+, MIC4, MIC500, MIC850.

## Integral Ignition Coils – Fat Design

For slow and mid speed gas engines it is favorable to have more spark energy available. MOTORTECH offers a full line of special and more powerful integral ignition coils with a proven design including different lengths and versions for use with MOTORTECH MIC3/3+, MIC4, MIC5, MIC500 and MIC850 series ignition controllers (support MOST and ASC technology) to meet the application and spark plug requirement.



Top cover with integrated HEX for easy installation/deinstallation



### 3 Pole Primary Connector Arrangement – MIC3/3+, MIC4, MIC5 Compatible – MOST



P/N <sup>1)</sup>	Supersedes	Color	Length	Primary Termination	HV Termination		Polarity	MOST	Equivalent to
					Outer Thread	Inner Thread			
95.09.142-11 <sup>2)</sup>	95.09.060-11	steel	11.00 in	MIL, 3 pole, pin		13/16-20 UNEF	(-) ground	X	
95.09.143-6 <sup>2)</sup>	95.09.013-6, 95.09.050-6	steel	6.00 in	MIL, 3 pole, pin	1-20 UNEF	13/16-20 UNEF	(-) ground	X	

<sup>1)</sup> Ignition coils in 12 in and 14.5 in only available on special request.

<sup>2)</sup> For use with MIC3/3+, MIC4, MIC5, MIC500, MIC850. P/N 95.09.142-11 for use on WAUKESHA® VHP-GSI with rain shield.

For existing installations with **ALTRONIC®** ignition controllers, MOTORTECH offers a special series of high energy integral ignition coils with 3 pole primary connector.

The ignition coils are designed to have the electrical characteristics to function with the **ALTRONIC®** patented “**Spark Reference**” high voltage indication system.

### 3 Pole Primary Connector Arrangement – ALTRONIC® Compatible



P/N <sup>1)</sup>	Supersedes	Color	Length	Primary Termination	HV Termination		Polarity	MOST	Equivalent to
					Outer Thread	Inner Thread			
95.09.122-11 <sup>2)</sup>	95.09.061-11	steel	11.00 in	MIL, 3 pole, pin		13/16-20 UNEF	(-) ground	not applicable	
95.09.123-6 <sup>2)</sup>	95.09.051-6	steel	6.00 in	MIL, 3 pole, pin	1-20 UNEF	13/16-20 UNEF	(-) ground	not applicable	

<sup>1)</sup> Ignition coils in 12 in and 14.5 in only available on special request.

<sup>2)</sup> For use with MIC500, ALT I, ALT III, ALT V, CD200, CD200D, DISN, CPU90, CPU95, CEC. P/N 95.09.122-11 for use on WAUKESHA® VHP-GSI with rain shield.

MOTORTECH high energy integral ignition coils are also available with 2 pole primary connector for use with MOTORTECH MIC3/3+, MIC4, MIC5, MIC500 and MIC850

(includes support of ASC and MOST feature) series ignition controllers.

### 2 Pole Primary Connector Arrangement – FAIRBANKS MORSE® Style – MOST



P/N <sup>1)</sup>	Supersedes	Color	Length	Primary Termination	HV Termination		Polarity	MOST	Equivalent to
					Outer Thread	Inner Thread			
95.08.142-11 <sup>2)</sup>	95.08.050-11	steel	11.00 in	MIL, 2 pole, pin		13/16-20 UNEF	(-) ground	X	
95.08.143-6 <sup>2)</sup>	95.08.020-6, 95.08.040-6	steel	6.00 in	MIL, 2 pole, pin	1-20 UNEF	13/16-20 UNEF	(-) ground	X	PPT2477AB-6

<sup>1)</sup> Ignition coils in 12 in (PPT2477AB-12) and 14.5 in only available on special request.

<sup>2)</sup> For use with MIC3/3+, MIC4, MIC5, MIC500, MIC850. P/N 95.08.142-11 for use on WAUKESHA® VHP-GSI with rain shield.

# Ignition Coils

As an additional accessory, MOTORTECH offers suitable grommets for certain applications. Made of Teflon® or silicone, these grommets perfectly fit the slim and fat design integral ignition coils and protect the spark plug well against dirt and fluids.



## Grommets for Integral Ignition Coils

P/N	Figure	Description	Material	Integral Ignition Coil Type	Engine Make and Model	Equivalent to
06.84.026	1	Grommet	Silicone	Slim Design	CATERPILLAR® G342, G379, G398, G399	9Y-3987, ICG-625
06.84.116	2	Grommet	Teflon®	Slim Design	CATERPILLAR® G3300 series	106-9185
06.84.117	2	Grommet	Teflon®	Slim Design	CATERPILLAR® G3400 series	9Y-7361
06.84.069	2	Grommet	Teflon®	Fat Design	WAUKESHA® VHP and VGF series	



1



2





# Pickups & Trigger Drives

## UNSHIELDED

### Pickups

A wide range of standard ignition pickups are available from MOTORTECH to allow service companies and operators to select what they need to do a professional installation. High quality, designed to meet the application and temperature requirements, MOTORTECH pickups will last and ensure you are not experiencing any unexpected shut downs.



#### Magnetic Pickups – Thread Size 5/8-18 UNF <sup>1)</sup>



P/N	Figure	Supersedes	Thread Size	Thread Length	Trigger	Equivalent to
66.60.001-125	1	06.60.101	5/8-18 UNF	1.25 in	holes, pins, teeth, screws	
66.60.001-175	1	06.60.105	5/8-18 UNF	1.75 in	holes, pins, teeth, screws	691118-1
66.60.001-250	1	06.60.102	5/8-18 UNF	2.50 in	holes, pins, teeth, screws	691118-2
66.60.001-400	1	06.60.103	5/8-18 UNF	4.00 in	holes, pins, teeth, screws	691118-4
66.60.001-600	1	06.60.107	5/8-18 UNF	6.00 in	holes, pins, teeth, screws	691118-6

<sup>1)</sup> Not for use with WAUKESHA® ESM system.

#### Hall Effect Pickups – Thread Size 5/8-18 UNF – Active Low



P/N	Figure	Supersedes	Thread Size	Thread Length	Trigger	Equivalent to
66.60.002-125	2		5/8-18 UNF	1.25 in	magnets	
66.60.002-175	2	06.60.020	5/8-18 UNF	1.75 in	magnets	791050-1
66.60.002-250	2	06.60.021	5/8-18 UNF	2.50 in	magnets	791050-2
66.60.002-450	2	06.60.022	5/8-18 UNF	4.50 in	magnets	791050-4
66.60.002-600	2		5/8-18 UNF	6.00 in	magnets	791050-6

#### Hall Effect Pickups – Thread Size 5/8-18 UNF – Active High <sup>1)</sup>



P/N	Figure	Supersedes	Thread Size	Thread Length	Trigger	Equivalent to
66.60.012-175	2		5/8-18 UNF	1.75 in	magnets	591014-1
66.60.012-250	2		5/8-18 UNF	2.50 in	magnets	591014-2
66.60.012-450	2		5/8-18 UNF	4.50 in	magnets	591014-4
66.60.012-600	2		5/8-18 UNF	6.00 in	magnets	591014-6

<sup>1)</sup> For use with ALTRONIC® CPU90, CPU95, CPU2000 ignition controllers.

#### Inductive Pickups – Thread Size M12x1



P/N	Figure	Supersedes	Thread Size	Thread Length	Trigger	Equivalent to
66.60.003-60	3	06.60.027, 06.60.042	M12x1	60 mm	pins, screws, slots	
66.60.003-100	3	06.60.023, 06.60.040	M12x1	100 mm	pins, screws, slots	

# Pickups & Trigger Drives



SHIELDED

## Magnetic Pickups – Thread Size 5/8-18 UNF <sup>1)</sup>



P/N	Figure	Supersedes	Thread Size	Thread Length	Trigger	Equivalent to
95.70.001-125	4		5/8-18 UNF	1.25 in	holes, pins, teeth, screws	
95.70.001-175	4		5/8-18 UNF	1.75 in	holes, pins, teeth, screws	691118-1
95.70.001-250	4		5/8-18 UNF	2.50 in	holes, pins, teeth, screws	691118-2
95.70.001-400	4		5/8-18 UNF	4.00 in	holes, pins, teeth, screws	691118-4
95.70.001-600	4		5/8-18 UNF	6.00 in	holes, pins, teeth, screws	691118-6

<sup>1)</sup> Not for use with WAUKESHA® ESM system.

## Hall Effect Pickups – Thread Size 5/8-18 UNF – Active Low



P/N	Figure	Supersedes	Thread Size	Thread Length	Trigger	Equivalent to
95.70.002-125	5		5/8-18 UNF	1.25 in	magnets	
95.70.002-175	5		5/8-18 UNF	1.75 in	magnets	791050-1
95.70.002-250	5		5/8-18 UNF	2.50 in	magnets	791050-2
95.70.002-450	5		5/8-18 UNF	4.50 in	magnets	791050-4
95.70.002-600	5		5/8-18 UNF	6.00 in	magnets	791050-6

## Hall Effect Pickups – Thread Size 5/8-18 UNF – Active High <sup>1)</sup>



P/N	Figure	Supersedes	Thread Size	Thread Length	Trigger	Equivalent to
95.70.012-175	5		5/8-18 UNF	1.75 in	magnets	591014-1
95.70.012-250	5		5/8-18 UNF	2.50 in	magnets	591014-2
95.70.012-450	5		5/8-18 UNF	4.50 in	magnets	591014-4
95.70.012-600	5		5/8-18 UNF	6.00 in	magnets	591014-6

<sup>1)</sup> For use with ALTRONIC® CPU90, CPU95, CPU2000 ignition controllers.

## Inductive Pickups – Thread Size M12x1



P/N	Figure	Supersedes	Thread Size	Thread Length	Trigger	Equivalent to
95.70.003-60	6		M12x1	60 mm	pins, screws, slots	
95.70.003-100	6		M12x1	100 mm	pins, screws, slots	

### Legend



slots



magnets



pins



teeth



screws



holes



See page 64 for available pickup thread adaptors.

Conversion: 1 inch = 25,4 mm / 1 foot = 0,3 m

# Pickups & Trigger Drives

## UNSHIELDED



### Special Application Pickups

For use with competitor ignition systems, MOTORTECH offers a special series of pickups. Based on the reliable design of MOTORTECH's standard versions, this series represents a suitable replacement for existing competitor pickups in the field.

#### Magnetic Pickups – Thread Size 3/4-16 UNF <sup>1)</sup>



P/N	Figure	Supersedes	Thread Size	Thread Length	Trigger	Equivalent to
66.60.011-180	1		3/4-16 UNF	1.80 in	holes, pins, teeth, screws	791015-1
66.60.011-340	1		3/4-16 UNF	3.40 in	holes, pins, teeth, screws	791016-2

<sup>1)</sup> For use with ALTRONIC® CD1, CD200, CD200D and CD200EVS ignition controllers.

#### Magnetic Pickup – Thread Size M12x1 <sup>1)</sup>



P/N	Figure	Supersedes	Thread Size	Thread Length	Trigger	Equivalent to
66.60.021-300	2		M12x1	3.00 in	holes, pins, teeth, screws	791041-3, 10.362-1, 600-00-111-00

<sup>1)</sup> For use with ALTRONIC® CD200, CD200D and CD200EVS ignition controllers.

#### Active Pickup – Thread Size M18x1 <sup>1)</sup>



P/N	Figure	Supersedes	Thread Size	Thread Length	Trigger	Equivalent to
66.60.023-450	3		M18x1	4.50 in	magnets	791037-4, 1229 9989

<sup>1)</sup> For use with MWM®/DEUTZ® gas engines.

#### Pickup Coil for ALTRONIC® I Magneto Ignition System

P/N	Figure	Supersedes	Connector	Lead Length	Trigger	Equivalent to
101181-MOT	4		MIL, 3 pole, socket, 180°	180.00 in (blue 200 in)	magnets	101181

#### Legend



Conversion: 1 inch = 25.4 mm/1 foot = 0.3 m

# Pickups & Trigger Drives



UNSHIELDED

## Pickup Leads

The reliability of an electronic ignition system comes with its accessories. Every pickup needs a lead to connect to the ignition controller and ensure that the signal is transmitted without any malfunctions. MOTORTECH offers high grade

pickup leads that are all shielded against EMI interference. Preferably a 90° connector is used as it routes the wire downwards and puts less side load stress on the pickup.

### Magnetic Pickup Leads



P/N	Figure	Supersedes	Connector	Lead Length	Equivalent to
06.71.001-L	1		MIL, 2 pole, socket, 90°	L= 5/15/25/50 ft	

### Hall Effect Pickup Leads



P/N	Figure	Supersedes	Connector	Lead Length	Equivalent to
06.71.002-L	2		MIL, 3 pole, socket, 90°	L= 5/15/25/50 ft	

### Inductive Pickup Lead



P/N	Figure	Supersedes	Connector	Lead Length	Equivalent to
06.71.007	3		4 pole, socket, 90°	400 in	

### Magnetic Pickup Leads

SHIELDED



P/N <sup>1)</sup>	Figure	Supersedes	Connector	Adaptor to Junction Box	Equivalent to
95.60.010-L	4		MIL, 2 pole, socket, 180°	1/2-14 NPT	593048-L
95.60.020-L	4		MIL, 2 pole, socket, 90°	1/2-14 NPT	593054-L

<sup>1)</sup> Standard braid lengths (-L) = 6 in, 12 in, 18 in, 24 in, 36 in, 48 in, 72 in, 96 in, 120 in, 150 in, 180 in; other lengths available on request.

### Hall Effect Pickup Leads



P/N <sup>1)</sup>	Figure	Supersedes	Connector	Adaptor to Junction Box	Equivalent to
95.60.030-L	5		MIL, 3 pole, socket, 180°	1/2-14 NPT	593052-L
95.60.040-L	5		MIL, 3 pole, socket, 90°	1/2-14 NPT	593057-L

<sup>1)</sup> Standard braid lengths (-L) = 6 in, 12 in, 18 in, 24 in, 36 in, 48 in, 72 in, 96 in, 120 in, 150 in, 180 in; other lengths available on request

### Inductive Pickup Lead



P/N	Figure	Supersedes	Connector	Lead Length	Adaptor to Junction Box	Equivalent to
95.60.050-400	6		4 pole, socket, 90°	400 in	M12x1.5	

### Pickup Harnesses for WAUKESHA® VHP Series Gas Engines with ESM

P/N	Figure	Description	Length	Equivalent to
A740749-MOT		Harness, crankshaft pickup	45 in	A740749
A740750-MOT		Harness, camshaft pickup	43 in	A740750



Special Application Pickups | Pickup Leads

## Pickups & Trigger Drives

### Trigger Discs

A large variety of different trigger discs is available to support upgrades performed by installing new electronic ignition systems on engines that used to be equipped with mechanical driven magnetos. Select between universal trigger discs with magnets, metal inlets or discs that are specially designed for particular engine models.



### Trigger Discs with Magnets

P/N	Supersedes	Description	Diameter	Events	Equivalent to
06.20.300		Trigger disc with magnet	5.00 in	1	
06.20.301		Trigger disc with magnet	7.45 in	1	
06.20.302		Trigger disc with magnets	5.00 in	2+1	
06.20.303		Trigger disc with magnets	7.45 in	2+1	
06.20.304		Trigger disc with magnets	5.00 in	3+1	
06.20.305		Trigger disc with magnets	7.45 in	3+1	
06.20.306		Trigger disc with magnets	5.00 in	4+1	790114-1
06.20.307		Trigger disc with magnets	7.45 in	4+1	790104-1
06.20.308		Trigger disc with magnets	5.00 in	5+1	790115-1
06.20.309		Trigger disc with magnets	7.45 in	5+1	790105-1
06.20.310		Trigger disc with magnets	3.40 in	6+1	790165
06.20.311		Trigger disc with magnets	4.00 in	6+1	790144
06.20.312		Trigger disc with magnets	5.00 in	6+1	790169
06.20.313		Trigger disc with magnets	5.00 in	6+1	790116-1
06.20.314		Trigger disc with magnets	7.45 in	6+1	790106-1
06.20.316		Trigger disc with magnets	5.00 in	8+1	790118-1
06.20.317		Trigger disc with magnets	7.45 in	8+1	790150
06.20.318		Trigger disc with magnets	7.45 in	8+1	790108-1
06.20.319		Trigger disc with magnets	7.45 in	8+1	790022
06.20.321		Trigger disc with magnets	7.45 in	12+1	790122-1
06.20.322		Trigger disc with magnets	7.45 in	12+1	790151
06.20.323		Trigger disc with magnets	7.45 in	12+1	790021

Conversion: 1 inch = 25,4 mm/1 foot = 0,3 m

## Trigger Discs with Magnets – Compatible with WAUKESHA® CEC Ignition System

P/N	Figure	Supersedes	Description	Application	Diameter	Events	Equivalent to
06.20.069-1	1		Trigger disc with magnet	WAUKESHA® VHP series	7.45 in	1	
06.20.069-6	1		Trigger disc with magnets	WAUKESHA® VHP series – 6 cylinders	7.45 in	6+1	305805R
06.20.069-12	1		Trigger disc with magnets	WAUKESHA® VHP series – 12 cylinders	7.45 in	12+1	305805P
06.20.254	2		Trigger disc with magnet	WAUKESHA® VHP series	5.35 in	1	
06.20.252	2		Trigger disc with magnets	WAUKESHA® VHP series – 16 cylinders	5.35 in	8+1	305805N
06.20.026-1 <sup>1)</sup>	3		Trigger disc with magnet	WAUKESHA® VHP series	7.45 in	1	
06.20.025 <sup>1)</sup>	3		Trigger disc with magnets	WAUKESHA® VHP series – 6 cylinders	7.45 in	6+1	305805F
06.20.026 <sup>1)</sup>	3	06.20.025-1	Trigger disc with magnets	WAUKESHA® VHP series – 12 cylinders	7.45 in	12+1	305805G
06.20.045-1	4		Trigger disc with magnet	WAUKESHA® VGF series	5.00 in	1	
06.20.045-6	4		Trigger disc with magnets	WAUKESHA® VGF series – 6 cylinders	5.00 in	6+1	305805
06.20.045-8	4		Trigger disc with magnets	WAUKESHA® VGF series – 8 cylinders	5.00 in	8+1	305805A

<sup>1)</sup> Comes with lock nut.

## Accessories for Trigger Discs for WAUKESHA® VHP Series Gas Engines

P/N	Figure	Supersedes	Description	Equivalent to
06.20.070	1B		Hub for trigger discs P/N 06.20.069-1/-6/-12	A168368E

## Trigger Discs with Metal Inlets

P/N	Figure	Supersedes	Description	Diameter	Events	Equivalent to
06.20.400	5		Trigger disc with metal inlets	7.45 in	2+1	790302-1
06.20.401	5		Trigger disc with metal inlets	7.45 in	3+1	790303-1
06.20.402	5		Trigger disc with metal inlets	5.00 in	4+1	790314-1
06.20.403	5		Trigger disc with metal inlets	5.00 in	6+1	790316-1
06.20.404	5		Trigger disc with metal inlets	5.00 in	8+1	790318-1

## Trigger Disc for IVECO® 5.9

P/N	Figure	Supersedes	Description	Diameter	Events	Equivalent to
06.20.251	6		Trigger disc with metal inlets	11.50 in	3+1	



Trigger Discs



# Pickups & Trigger Drives

## Reluctor Pins & Trigger Magnets

### Reluctor Pin

P/N	Figure	Supersedes	Description	Diameter	Length	Equivalent to
06.80.104	1		Reluctor pin	0.25 in	0.75 in	

See page 64 for reluctor pin installation tool.

### Trigger Magnets

P/N	Figure	Supersedes	Description	Thread	Length	Equivalent to
06.60.900	2		Trigger magnet	1/4-20 UNC	0.65 in	
06.60.922	2		Trigger magnet	M8x1.25	0.70 in	720002
06.60.925	3		Trigger magnet for CATERPILLAR® G3500 series	M8x1.25	1.34 in	260605, 260604

## Trigger Drives

### Trigger Conversion Kits for CATERPILLAR® G3300 & G3400 Series Gas Engines

P/N	Figure	Supersedes	Description	Events	Equivalent to
75.30.131-1	4	75.30.119-1, 75.30.101-1	Trigger conversion kit for CATERPILLAR® G3304/G3306	1	
75.30.132 <sup>1)</sup>	4	75.30.119	Trigger conversion kit for CATERPILLAR® G3304	4+1	
75.30.131 <sup>1)</sup>	4	75.30.101	Trigger conversion kit for CATERPILLAR® G3306	6+1	
75.30.133-1	4	75.30.100-1	Trigger conversion kit for CATERPILLAR® G3406	1	
75.30.133 <sup>1)</sup>	4	75.30.100	Trigger conversion kit for CATERPILLAR® G3406	6+1	

<sup>1)</sup> Trigger conversion kits also included in ignition kits (unshielded/shielded) for CATERPILLAR® G3300 & G3400 series gas engines.

### Accessories for Trigger Conversion Kits for CATERPILLAR® G3300 & G3400 Series Gas Engines

P/N	Figure	Supersedes	Description	Engine	Equivalent to
24.95.002 <sup>1)</sup>	4a		Flange cover plate for magneto	G3300, G3400	
44.04.005 <sup>2)</sup>	4b		Fork spanner, swan-necked	G3406	

<sup>1)</sup> Flange cover plate also included in ignition kits (unshielded/shielded) for CATERPILLAR® G3300 & G3400 series gas engines.

<sup>2)</sup> Needs to be ordered separately.



1

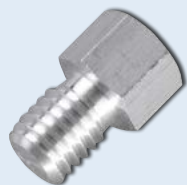

2



3



4

# Pickups & Trigger Drives



## Trigger Conversion Kit for DOOSAN® GV222TI Gas Engine

P/N	Figure	Supersedes	Description	Events	Equivalent to
75.30.137 <sup>1)</sup>	5		Trigger conversion kit for DOOSAN® GV222TI	6+1	

<sup>1)</sup> Required pickup P/N 66.60.003-60 and pickup lead P/N 06.71.007 have to be ordered separately. Only for use, when GILL® ignition system was installed before. Illustration shows mounted kit on camshaft gear.

## Trigger Drives for WHITE SUPERIOR® G825 & GT825 Gas Engines

P/N	Figure	Supersedes	Description	Events	Equivalent to
06.22.400-1 <sup>1)</sup>	6		Trigger drive for WHITE SUPERIOR® G825, GT825	1	
06.22.400-6 <sup>1)</sup>	6		Trigger drive for WHITE SUPERIOR® G825, GT825	6+1	
06.22.400-8 <sup>1)</sup>	6		Trigger drive for WHITE SUPERIOR® G825, GT825	8+1	

<sup>1)</sup> Required pickup P/N 66.60.003-60 and pickup lead P/N 06.71.007 have to be ordered separately.

## Trigger Drive for MAN® E2842 E302 & DOOSAN® GV222TI Gas Engines

P/N	Figure	Supersedes	Description	Events	Equivalent to
06.23.001 <sup>1)</sup>	7		Trigger drive for MAN® E2842 E302, DOOSAN® GV222TI	6+1	

<sup>1)</sup> Required pickup P/N 66.60.003-60 and pickup lead P/N 06.71.007 have to be ordered separately.

## Trigger Drive for MAN® E2866 E302 Gas Engine

P/N	Figure	Supersedes	Description	Events	Equivalent to
06.23.004 <sup>1)</sup>	8		Trigger drive for MAN® E2866 E302	6+1	

<sup>1)</sup> Required pickup P/N 66.60.003-60 and pickup lead P/N 06.71.007 have to be ordered separately.



# Pickups & Trigger Drives



## Trigger Devices

For applications where a trigger disc cannot be mounted due to difficult camshaft access, a trigger device is available. This unit is mounted at the location where the ignition magneto was installed. A built in trigger disc will sense the events necessary to trigger the ignition control unit. One (1) to a maximum of eight (8) trigger events are possible.

This covers most of the engines up to 16 cylinders operated in the field today. A proper mounting flange can be selected from a variety of flange designs typically used in the industry. Heavy duty bearings and a smart product design offer a long operating life cycle.

## Specification Table

Before trying to specify the correct trigger device, please make available the ignition magneto part number. For details you might even want to look up the **ALTRONIC®** application chart. That information will lead you to the MOTORTECH TriDev part number.

If any help is required, please call your nearest MOTORTECH sales partner.

ALTRONIC III MEDIUM ENGINES, 2-16 CYLINDERS		IDENTIFICATION FORM AIR AL 12-95
ALTRONIC III UNIT PART NO. DESIGNATION		
PART NO. - R-E-S		
MOUNTING	A = Vertical Flange, 1 slot B1 = Base Mount, 4 slots C1 = Horizontal Flange, 1 slot, 2 slots D = Base Mount, 2 slots E = Horizontal Flange, 2 slots G1 = Horizontal Flange, gear coupling G2 = Horizontal Flange, 2 slots, gear coupling G3 = Vertical Flange, 2 slots G4 = Vertical Flange, 2 slots, gear coupling G = Vertical Flange, 2 slots	
OPTIONS	H = High Output Option T = Electronic Timing Option	
STATOR WINDING	0 = 101 1 = 201 001 2 = 201 002 3 = 201 004 4 = 201 004 5 = 201 004 6 = 201 004	
GEAR RATIO	1 = 1 2 = 2:1 3 = 3:1 4 = 4:1 5 = 5:1 6 = 6:1	
FIRING PATTERN	A = Even Firing Pattern Other Letters = Odd Firing Pattern	
NO. CYLINDERS	2, 3, 4, 5, 6, 7, 8, 9, 10, 12, 16	

Refer to **ALTRONIC III Application List – Chapter Identification** – and choose **Gear Ratio** from **Part Number Designation** of former used magneto.

ALTRONIC III MEDIUM ENGINES, 2-16 CYLINDERS		APPLICATION LIST FORM AIR AL 12-95			
ENGINE MODEL NO.	DRIVE METHOD	ALTRONIC III UNIT NO.	WINDING NUMBER	QTY. CODES	NOTES
<b>CATERPILLAR</b>					
3208	1.0	13A011A	300 010-1	8	S, H
3208	1.0	13A011A	300 010-2	8	S, H
3208	1.0	13A011A	300 010-3	8	S, H
3208	1.0	13A011A	300 010-4	8	S, H
3208	1.0	13A011A	300 010-5	8	S, H
3208	1.0	13A011A	300 010-6	8	S, H
3208	1.0	13A011A	300 010-7	8	S, H
3208	1.0	13A011A	300 010-8	8	S, H
3208	1.0	13A011A	300 010-9	8	S, H
3208	1.0	13A011A	300 010-10	8	S, H
3208	1.0	13A011A	300 010-11	8	S, H
3208	1.0	13A011A	300 010-12	8	S, H
3208	1.0	13A011A	300 010-13	8	S, H
3208	1.0	13A011A	300 010-14	8	S, H
3208	1.0	13A011A	300 010-15	8	S, H
3208	1.0	13A011A	300 010-16	8	S, H
3208	1.0	13A011A	300 010-17	8	S, H
3208	1.0	13A011A	300 010-18	8	S, H
3208	1.0	13A011A	300 010-19	8	S, H
3208	1.0	13A011A	300 010-20	8	S, H
3208	1.0	13A011A	300 010-21	8	S, H
3208	1.0	13A011A	300 010-22	8	S, H
3208	1.0	13A011A	300 010-23	8	S, H
3208	1.0	13A011A	300 010-24	8	S, H
3208	1.0	13A011A	300 010-25	8	S, H
3208	1.0	13A011A	300 010-26	8	S, H
3208	1.0	13A011A	300 010-27	8	S, H
3208	1.0	13A011A	300 010-28	8	S, H
3208	1.0	13A011A	300 010-29	8	S, H
3208	1.0	13A011A	300 010-30	8	S, H
3208	1.0	13A011A	300 010-31	8	S, H
3208	1.0	13A011A	300 010-32	8	S, H
3208	1.0	13A011A	300 010-33	8	S, H
3208	1.0	13A011A	300 010-34	8	S, H
3208	1.0	13A011A	300 010-35	8	S, H
3208	1.0	13A011A	300 010-36	8	S, H
3208	1.0	13A011A	300 010-37	8	S, H
3208	1.0	13A011A	300 010-38	8	S, H
3208	1.0	13A011A	300 010-39	8	S, H
3208	1.0	13A011A	300 010-40	8	S, H
3208	1.0	13A011A	300 010-41	8	S, H
3208	1.0	13A011A	300 010-42	8	S, H
3208	1.0	13A011A	300 010-43	8	S, H
3208	1.0	13A011A	300 010-44	8	S, H
3208	1.0	13A011A	300 010-45	8	S, H
3208	1.0	13A011A	300 010-46	8	S, H
3208	1.0	13A011A	300 010-47	8	S, H
3208	1.0	13A011A	300 010-48	8	S, H
3208	1.0	13A011A	300 010-49	8	S, H
3208	1.0	13A011A	300 010-50	8	S, H
3208	1.0	13A011A	300 010-51	8	S, H
3208	1.0	13A011A	300 010-52	8	S, H
3208	1.0	13A011A	300 010-53	8	S, H
3208	1.0	13A011A	300 010-54	8	S, H
3208	1.0	13A011A	300 010-55	8	S, H
3208	1.0	13A011A	300 010-56	8	S, H
3208	1.0	13A011A	300 010-57	8	S, H
3208	1.0	13A011A	300 010-58	8	S, H
3208	1.0	13A011A	300 010-59	8	S, H
3208	1.0	13A011A	300 010-60	8	S, H
3208	1.0	13A011A	300 010-61	8	S, H
3208	1.0	13A011A	300 010-62	8	S, H
3208	1.0	13A011A	300 010-63	8	S, H
3208	1.0	13A011A	300 010-64	8	S, H
3208	1.0	13A011A	300 010-65	8	S, H
3208	1.0	13A011A	300 010-66	8	S, H
3208	1.0	13A011A	300 010-67	8	S, H
3208	1.0	13A011A	300 010-68	8	S, H
3208	1.0	13A011A	300 010-69	8	S, H
3208	1.0	13A011A	300 010-70	8	S, H
3208	1.0	13A011A	300 010-71	8	S, H
3208	1.0	13A011A	300 010-72	8	S, H
3208	1.0	13A011A	300 010-73	8	S, H
3208	1.0	13A011A	300 010-74	8	S, H
3208	1.0	13A011A	300 010-75	8	S, H
3208	1.0	13A011A	300 010-76	8	S, H
3208	1.0	13A011A	300 010-77	8	S, H
3208	1.0	13A011A	300 010-78	8	S, H
3208	1.0	13A011A	300 010-79	8	S, H
3208	1.0	13A011A	300 010-80	8	S, H
3208	1.0	13A011A	300 010-81	8	S, H
3208	1.0	13A011A	300 010-82	8	S, H
3208	1.0	13A011A	300 010-83	8	S, H
3208	1.0	13A011A	300 010-84	8	S, H
3208	1.0	13A011A	300 010-85	8	S, H
3208	1.0	13A011A	300 010-86	8	S, H
3208	1.0	13A011A	300 010-87	8	S, H
3208	1.0	13A011A	300 010-88	8	S, H
3208	1.0	13A011A	300 010-89	8	S, H
3208	1.0	13A011A	300 010-90	8	S, H
3208	1.0	13A011A	300 010-91	8	S, H
3208	1.0	13A011A	300 010-92	8	S, H
3208	1.0	13A011A	300 010-93	8	S, H
3208	1.0	13A011A	300 010-94	8	S, H
3208	1.0	13A011A	300 010-95	8	S, H
3208	1.0	13A011A	300 010-96	8	S, H
3208	1.0	13A011A	300 010-97	8	S, H
3208	1.0	13A011A	300 010-98	8	S, H
3208	1.0	13A011A	300 010-99	8	S, H
3208	1.0	13A011A	300 010-100	8	S, H

Refer to **ALTRONIC III Application List** and choose **Rotation** of your engine make and model from the list.

Selection **1 to 8** for use with inductive pickups only. Requires - **E** - **Pickup Port Arrangement A**. Selection **9** for use with Hall effect pickups only. Requires - **E** - **Pickup Port Arrangement F**.

ALTRONIC III MEDIUM ENGINES, 2-16 CYLINDERS		IDENTIFICATION FORM AIR AL 12-95
PART NO. DESIGNATION		
PART NO. - R-E-S		
MOUNTING	A = Vertical Flange, 1 slot B1 = Base Mount, 4 slots C1 = Horizontal Flange, 1 slot, 2 slots D = Base Mount, 2 slots E = Horizontal Flange, 2 slots G1 = Horizontal Flange, gear coupling G2 = Horizontal Flange, 2 slots, gear coupling G3 = Vertical Flange, 2 slots G4 = Vertical Flange, 2 slots, gear coupling G = Vertical Flange, 2 slots	
OPTIONS	H = High Output Option T = Electronic Timing Option	
STATOR WINDING	0 = 101 1 = 201 001 2 = 201 002 3 = 201 004 4 = 201 004 5 = 201 004 6 = 201 004	
GEAR RATIO	1 = 1 2 = 2:1 3 = 3:1 4 = 4:1 5 = 5:1 6 = 6:1	
FIRING PATTERN	A = Even Firing Pattern Other Letters = Odd Firing Pattern	
NO. CYLINDERS	2, 3, 4, 5, 6, 7, 8, 9, 10, 12, 16	

Refer to **ALTRONIC III Application List - Chapter Identification** - and choose Flange option from Part Number Designation of former used magneto.

Selection **A** to be used for - **C** - **Trigger Arrangement 1 to 8** only. Selection **F** to be used for - **C** - **Trigger Arrangement 9** only.

# Pickups & Trigger Drives

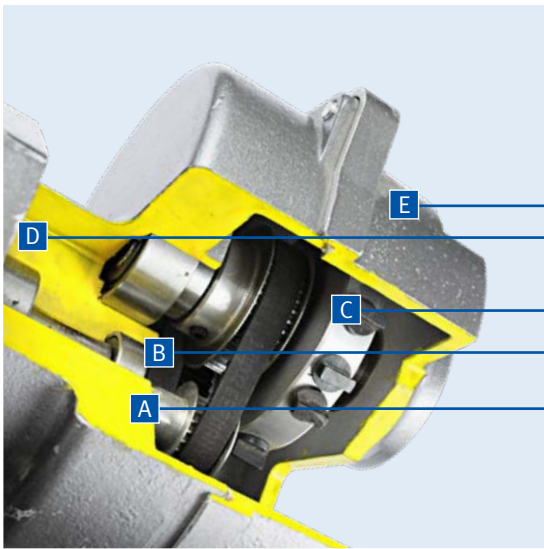

P/N 06.22. **A B C - D - E**

A		Gear Ratio	
1		1:1	
2		2:1	
3		3:1	
6		1.5:1	
B		Rotation	
1		CW (clockwise)	
2		CCW (counterclockwise)	
C		Trigger Arrangement	
1	1	Pin	Multiple pickup arrangement
2	2+1	Pins	Single pickup arrangement
3	3+1	Pins	Single pickup arrangement
4	4+1	Pins	Single pickup arrangement
6	6+1	Pins	Single pickup arrangement
8	8+1	Pins	Single pickup arrangement
9	1	Magnet	Multiple pickup arrangement
D		Flange	
A		Flange mount, vertical, 1 slot	
B		Base mount	
D		Flange mount, horizontal, 3 in. pilot, 2 slots	
G		Flange mount, horizontal, 2 slots	
GL		Flange mount, horizontal, flex coupling	
GN		Flange mount, horizontal, gear coupling	
GO		Flange mount, horizontal, 2 slots	
GV		Flange mount, vertical, 2 slots	
GVN		Flange mount, vertical, gear coupling	
J		Flange mount, vertical, 3 slots	
E		Pickup Port Arrangement	
A	M12 x 1	Pickup port for inductive pickup	
F	5/8-18 UNF	Pickup port for Hall effect pickup	

**NOTE:** Pickup and pickup lead have to be ordered separately.

# Pickups & Trigger Drives

## Tools & Accessories

### Installation Tool for Reluctor Pin

P/N	Figure	Supersedes	Description	Equivalent to
44.99.011	1		Installation tool for reluctor pin	

### Thread Adaptors

P/N	Figure	Supersedes	Description	Outer Thread	Inner Thread	Length	Equivalent to
06.60.908	2		Thread adaptor	5/8-18 UNF	M12x1	40 mm	
06.60.926	2		Thread adaptor	M18x1	M12x1	40 mm	
06.95.058	2		Thread adaptor	3/4-16 UNF	M12x1	24 mm	

### Junction Boxes

P/N	Figure	Supersedes	Description	Connection	Hubs	Equivalent to
15.02.226	3		Junction box	1/2 in	2	
15.02.326	4		Junction box	1/2 in	3	
15.02.426	5		Junction box	1/2 in	4	

### Drive Coupling for Magnetos and TriDev Trigger Devices

P/N	Figure	Supersedes	Description	Equivalent to
06.75.103	6	06.75.102	Drive coupling with roll pin, black	510454-P, 510454-U

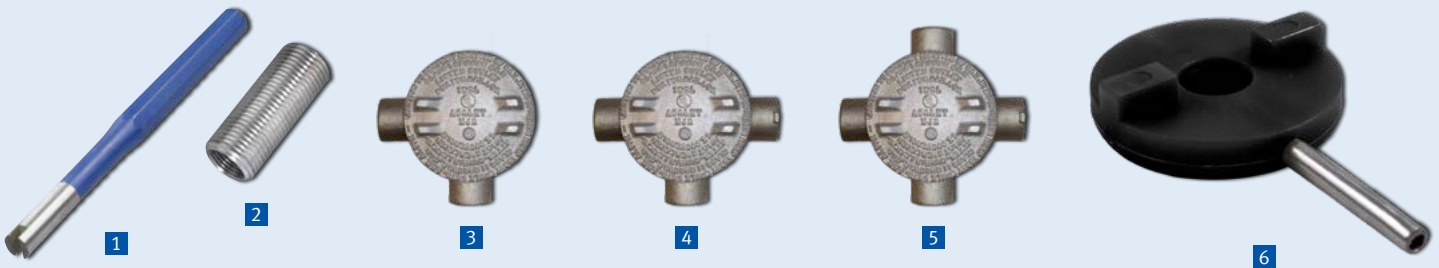





# Primary Leads

SHIELDED

## Primary Leads – New Flex Style

In addition to its conventional primary leads, MOTORTECH offers a new type of primary lead that is produced with a special wire. The new primary leads are compliant with CSA Class I, Division 2, Group D, and they offer a significantly higher flexibility than conventional leads, shielded with braided steel, while being highly resistant to all kinds of environmental conditions.

The multi-layer design of the wire is free of entrapped air and prevents the accumulation of condensed water which can result in primary voltage flash-overs. Several different configurations with durable 90-degree and 180-degree 2-pole and 3-pole connectors are available.



The oil and UV resistant multi-conductor wire is specially designed for shielded CSA certified primary leads. It consists of a multi layer design:

- Fine bare copper wire
- PVC/Nylon insulation
- Aluminum-plated foil and tinned copper braid
- PVC jacket
- Temperature range -40° C to +90° C (-40° F to +194° F)

This design ensures that no humidity can be trapped in the lead.

# Primary Leads

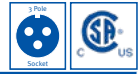

## Primary Leads – 3 Pole Ignition Coil Connection – NPT Adaptors to Junction Box

Shielded		Unshielded	Ignition Coil Connector	Junction Box Adaptor	Conductor	Equivalent to <sup>2)</sup>
New Flex Style	Conventional Style					
P/N <sup>1)</sup>						
95.01.110-L	95.01.010-L		MIL, 3 pole, socket, 180°	1/2-14 NPT, 180°	2 wire	593022-L
95.01.110-L-3	95.01.010-L-3		MIL, 3 pole, socket, 180°	3/8-18 NPT, 180°	2 wire	LT73002-L
95.01.120-L	95.01.020-L		MIL, 3 pole, socket, 90°	1/2-14 NPT, 180°	2 wire	593027-L
95.01.120-L-3	95.01.020-L-3		MIL, 3 pole, socket, 90°	3/8-18 NPT, 180°	2 wire	LT73012-L
95.01.121-L	95.01.021-L		MIL, 3 pole, socket, 90°	1/2-14 NPT, 180°	2 wire	593029-L
95.01.122-L	95.01.022-L		MIL, 3 pole, socket, 90°	1/2-14 NPT, 180°	2 wire <sup>3)</sup>	593036-L
95.01.123-L	95.01.023-L		MIL, 3 pole, socket, 180°	1/2-14 NPT, 180°	2 wire <sup>3)</sup>	593035-L

<sup>1)</sup> Standard braid lengths (-L) = 6 in, 9 in, 12 in, 15 in, 18 in, 24 in, 30 in, 36 in, 42 in, 48 in, 54 in, 60 in, 72 in, 84 in, 96 in, 108 in, 120 in, 135 in, 138 in, 150 in; other lengths available on request.

<sup>2)</sup> Shown cross references refer to MOTORTECH Conventional Style primary leads. New Flex Style primary leads can be used instead as an upgrade.

<sup>3)</sup> Wire length is double of braid length.

## Repair Kits for Conventional Style Shielded Primary Leads – 3 Pole Ignition Coil Connection



P/N	Description	Lead Length	Ignition Coil Connector	Conductor	For use with Primary Lead, Length 10 to 180 in	Equivalent to
95.01.010-42-RC	Repair kit	42 in	MIL, 3 pole, socket, 180°	2 wire	95.01.010-L, 593022-L	583017-42
95.01.010-60-RC	Repair kit	60 in	MIL, 3 pole, socket, 180°	2 wire	95.01.010-L, 593022-L	583017-60
95.01.010-96-RC	Repair kit	96 in	MIL, 3 pole, socket, 180°	2 wire	95.01.010-L, 593022-L	583017-96
95.01.010-180-RC	Repair kit	180 in	MIL, 3 pole, socket, 180°	2 wire	95.01.010-L, 593022-L	583017-180
95.01.020-42-RC	Repair kit	42 in	MIL, 3 pole, socket, 90°	2 wire	95.01.020-L, 593027-L	583018-42
95.01.020-60-RC	Repair kit	60 in	MIL, 3 pole, socket, 90°	2 wire	95.01.020-L, 593027-L	583018-60
95.01.020-96-RC	Repair kit	96 in	MIL, 3 pole, socket, 90°	2 wire	95.01.020-L, 593027-L	583018-96
95.01.020-180-RC	Repair kit	180 in	MIL, 3 pole, socket, 90°	2 wire	95.01.020-L, 593027-L	583018-180



# Primary Leads

## Primary Leads – 2 Pole Ignition Coil Connection – NPT Adaptors to Junction Box

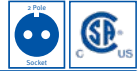

Shielded		Unshielded	Ignition Coil Connector	Junction Box Adaptor	Conductor	Equivalent to <sup>2)</sup>
New Flex Style	Conventional Style					
P/N <sup>1)</sup>						
95.06.110-L	95.06.010-L		MIL, 2 pole, socket, 180°	1/2-14 NPT, 180°	2 wire	A754-L, LT2001-L
95.06.120-L	95.06.020-L		MIL, 2 pole, socket, 90°	1/2-14 NPT, 180°	2 wire	B754-L, LT2011-L
	95.06.030-L		MIL, 2 pole, socket, 180°	5/8-24 NPT, 90°	2 wire	C754-L, LT2100-L

<sup>1)</sup> Standard braid lengths (-L) = 6 in, 9 in, 12 in, 15 in, 18 in, 24 in, 30 in, 36 in, 42 in, 48 in, 54 in, 60 in, 72 in, 84 in, 96 in, 108 in, 120 in, 135 in, 138 in, 150 in; other lengths available on request.

<sup>2)</sup> Shown cross references refer to MOTORTECH Conventional Style primary leads. New Flex Style primary leads can be used instead as an upgrade.

## Primary Leads – 3 Pole Ignition Coil Connection – Special

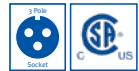

Shielded		Unshielded	Ignition Coil Connector	Electronic Box Connector	Conductor	Equivalent to <sup>2)</sup>
New Flex Style	Conventional Style					
P/N <sup>1)</sup>						
95.01.130-L	95.01.030-L		MIL, 3 pole, socket, 90°	MIL, 3 pole, socket, 180°	2 wire	593069-L
95.01.131-L	95.01.031-L		MIL, 3 pole, socket, 90°	MIL, 3 pole, pin, 90°	2 wire	
95.01.133-L	95.01.033-L		MIL, 3 pole, socket, 90°	MIL, 3 pole, socket, 180°	3 wire	

<sup>1)</sup> Standard braid lengths (-L) = 6 in, 9 in, 12 in, 15 in, 18 in, 24 in, 30 in, 36 in, 42 in, 48 in, 54 in, 60 in, 72 in, 84 in, 96 in, 108 in, 120 in, 135 in, 138 in, 150 in; other lengths available on request.

<sup>2)</sup> Shown cross references refer to MOTORTECH Conventional Style primary leads. New Flex Style primary leads can be used instead as an upgrade.

## Primary Leads – 2 Pole Ignition Coil Connection – Special

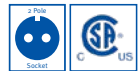

Shielded		Unshielded	Ignition Coil Connector	Electronic Box Connector	Conductor	Equivalent to
New Flex Style	Conventional Style					
P/N <sup>1)</sup>						
95.01.132-L	95.01.032-L		MIL, 2 pole, pin, 90°	MIL, 2 pole, pin, 90°	2 wire	

<sup>1)</sup> Standard braid lengths (-L) = 6 in, 9 in, 12 in, 15 in, 18 in, 24 in, 30 in, 36 in, 42 in, 48 in, 54 in, 60 in, 72 in, 84 in, 96 in, 108 in, 120 in, 135 in, 138 in, 150 in; other lengths available on request.



# Primary Leads



## Cable Assemblies – NPT Adaptors to Junction Box



Shielded		Unshielded	Ignition Coil Connector	Outlet Junction Adaptor	Conductor	Equivalent to <sup>2)</sup>
New Flex Style	Conventional Style					
P/N <sup>1)</sup>						
95.01.111-L	95.01.011-L		MIL, 3 pole, socket, 180°	1/2-14 NPT, 180°	3 wire	
95.01.124-L	95.01.024-L		MIL, 3 pole, socket, 90°	1/2-14 NPT, 180°	3 wire	593024-L
	95.01.025-L		MIL, 4 pole, socket, 90°	1/2-14 NPT, 180°	5 wire	593025-L
	95.01.026-L		MIL, 5 pole, socket, 90°	1/2-14 NPT, 180°	6 wire	593026-L

<sup>1)</sup> Standard braid lengths (-L) = 6 in, 9 in, 12 in, 15 in, 18 in, 24 in, 30 in, 36 in, 42 in, 48 in, 54 in, 60 in, 72 in, 84 in, 96 in, 108 in, 120 in, 135 in, 138 in, 150 in; other lengths available on request.

<sup>2)</sup> Shown cross references refer to MOTORTECH Conventional Style primary leads. New Flex Style primary leads can be used instead as an upgrade.

## Special Application Primary Leads

### Primary Leads for ROLLS-ROYCE® Gas Engines



Shielded		Unshielded	Ignition Coil Connector	Wiring Rail Connector	Conductor	Equivalent to
New Flex Style	Conventional Style					
P/N <sup>1)</sup>						
	95.01.012-14		MIL, 3 pole, socket, 90°	3 pole, socket, 90°	2 wire	702930, 593068-1
	95.01.013-30		MIL, 3 pole, socket, 90°	3 pole, socket, 180°	2 wire	705165, 593068-2

<sup>1)</sup> Standard braid lengths 14 in and 30 in; other lengths available on request.

### Primary Leads for WAUKESHA® ESM Gas Engines



Shielded		Unshielded	Ignition Coil Connector	Wiring Rail Connector	Conductor	Equivalent to <sup>2)</sup>
New Flex Style	Conventional Style					
P/N						
95.01.107-24 <sup>1)</sup>		A740746-MOT	MIL, 3 pole, socket, 90°	3 pole, socket, 180°	2 wire	A740746, 740746D
		740746B-MOT	2 wire, 180°	3 pole, socket, 180°	2 wire	740746B

<sup>1)</sup> Standard lead length 24 in; other lengths available on request.

<sup>2)</sup> Shown cross references refer to unshielded primary leads. New Flex Style primary leads can be used instead as an upgrade.

### Primary Lead for ALTRONIC® EZRAIL Ignition Rail System – Unshielded



P/N <sup>1)</sup>	Description	Ignition Coil Connector	Lead Length	Conductor	Equivalent to
06.30.111-60	Primary lead	MIL, 3 pole, socket, 180°	60 in	2 wire	583017-60KT

<sup>1)</sup> Other lengths available on request.

### Primary Leads for WAUKESHA® ESM Gas Engines



P/N A740746-MOT



P/N 740746B-MOT

# Primary Leads



## Primary Leads for MOTORTECH AlphaRail Wiring Rails

For linking flange, integral or externally mounted ignition coils to its AlphaRail ignition wiring rails, MOTORTECH offers a special series of primary leads. Several different configurations are available to offer an individual solution for any application.

- 1 2 or 3 pole MIL style connectors as 90° or 180° type for ignition coil connection
- 2 Primary leads available for shielded applications (Conventional or New Flex Style) or unshielded applications
- 3 2 pole MIL style connector as 90° or 180° type for wiring rail connection



Shielded		Unshielded	Ignition Coil Connector	Wiring Rail Connector	Conductor	Equivalent to
New Flex Style	Conventional Style					
P/N <sup>1)</sup>						
95.01.140-L	95.01.040-L	06.01.040-L	MIL, 3 pole, socket, 180°	MIL, 2 pole, pin, 180°	2 wire	
95.01.141-L	95.01.041-L	06.01.041-L	MIL, 3 pole, socket, 90°	MIL, 2 pole, pin, 180°	2 wire	
95.01.142-L	95.01.042-L	06.01.042-L	MIL, 2 pole, socket, 180°	MIL, 2 pole, pin, 180°	2 wire	
95.01.143-L	95.01.043-L	06.01.043-L	MIL, 2 pole, socket, 90°	MIL, 2 pole, pin, 180°	2 wire	
95.01.144-L	95.01.044-L	06.01.044-L	MIL, 3 pole, socket, 180°	MIL, 2 pole, pin, 90°	2 wire	
95.01.145-L	95.01.045-L	06.01.045-L	MIL, 3 pole, socket, 90°	MIL, 2 pole, pin, 90°	2 wire	
95.01.146-L	95.01.046-L	06.01.046-L	MIL, 2 pole, socket, 180°	MIL, 2 pole, pin, 90°	2 wire	
95.01.147-L	95.01.047-L	06.01.047-L	MIL, 2 pole, socket, 90°	MIL, 2 pole, pin, 90°	2 wire	

<sup>1)</sup> Standard lead lengths (-L) = 6 in, 9 in, 12 in, 15 in, 18 in, 24 in, 30 in, 36 in, 42 in, 48 in, 54 in, 60 in, 72 in, 84 in; other lengths available on request. Add suffix "-X" to part number for cross wired primary leads for positive grounded ignition systems (e.g. 95.01.140-18-X).

New Flex Style



Conventional Style



Unshielded

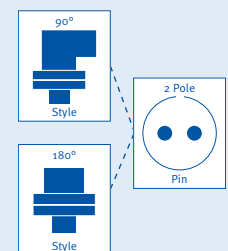
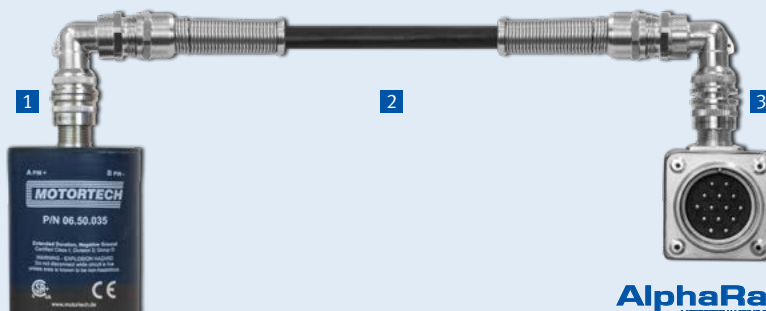
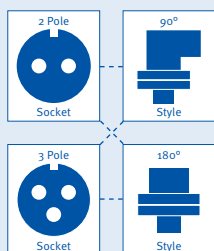





# Spark Plug Leads & Extensions

UNSHIELDED



## PolyMot™ Spark Plug Leads

MOTORTECH's PolyMot™ spark plug lead was globally patented in 1996. Since then more than one million leads were manufactured to this design. These spark plug leads are unique and offer several advantages when being compared to the OEM or aftermarket competition. With the knowledge gathered in ignition control and ignition coil research and manufacturing, a lot of the details were implemented into these products. The unique structure has achieved tremendous reliability records in the field.

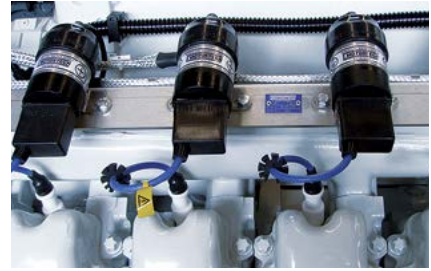

### General Features

- Rigid design
- Insulators made of high quality Teflon® and up to 36 inch length
- Ceramic insert with 5 kΩ resistor for EMI suppression (0 kΩ available on request)
- Reliable ignition coil and spark plug terminals
- Critical high voltage areas are protected with seals
- Designed to match the engine model, the spark plug type and application
- Insulators are labeled with P/N and production code for easy traceability
- Long life product

### Key Design Features

- 1 Reliable terminals to fit a large variety of different ignition coil types
- 2 The blue ignition cable is specially designed for high dielectric strength
- 3 Special silicone boots for wire output with excellent temperature and aging characteristics
- 4 Highest dielectric strength due to Teflon® insulator
- 5 Ceramic insert with 5 kΩ resistor for EMI suppression
- 6 Integrated silicone seal rings for best flashover protection will not stick on the spark plug insulator when pulling off the Teflon® insulator



# Spark Plug Leads & Extensions



## Specification Table

Please consult factory or your nearest MOTORTECH distributor to get the correct PolyMot™ spark plug lead specified for your engine application.

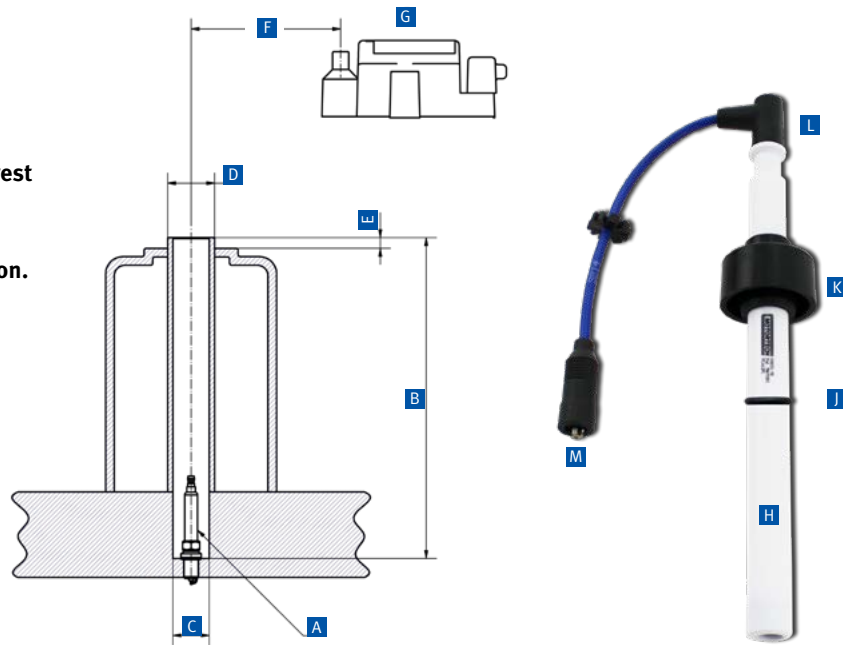

### Questionnaire for PolyMot™ Specification.

Engine make	
Series	
Engine model	
Spark plug make and model <b>A</b>	
Spark plug well depth <b>B</b>	
Spark plug well inner diameter <b>C</b>	
Spark plug well outer diameter <b>D</b>	
Spark plug well to valve cover distance <b>E</b>	
Length of ignition cable <b>F</b>	
Ignition coil make and model <b>G</b>	
Built in 5 kΩ ceramic resistor (recommended) <b>H</b>	<input type="checkbox"/> Yes <input type="checkbox"/> No
Seal ring on Teflon® insulator <b>J</b>	<input type="checkbox"/> Yes <input type="checkbox"/> No
Grommet to cover the spark plug well <b>K</b>	<input type="checkbox"/> Yes <input type="checkbox"/> No
Lead output from Teflon® insulator <b>L</b>	<input type="checkbox"/> 90° <input type="checkbox"/> 180°
Terminal to ignition coil (preferred) <b>M</b>	<input type="checkbox"/> 90° <input type="checkbox"/> 180°

# Spark Plug Leads & Extensions

## UNSHIELDED

PolyMot™ Spark Plug Leads – for common Applications

P/N	Engine Make	Model	Spark Plug	P/N Silicone Seal Ring	Teflon® Insulator Length	Resistance <sup>1)</sup>	Lead Output from Teflon® Insulator	Ignition Cable Length <sup>2)</sup>	Ignition Coil Connection	Equivalent to
06.85.908-22	AJAX®	2802	3076	06.84.059	6 in	6 kΩ	180°	17 in	6	
06.85.1047-24	AJAX®	DPC2802	W80N	06.84.040	5 in	5 kΩ	180°	19 in	5A	
06.85.1054-18	CATERPILLAR®	G3400 series	B4321	06.84.044	13 in	5 kΩ	90°	18 in	1	
06.85.751-18	CATERPILLAR®	G3400 series	GE3-5, RN79G	06.84.059	13 in	5 kΩ	90°	18 in	1	262-4855, 250-2149
06.85.1019-16	CATERPILLAR®	G3400 series	GE3-5, RN79G	06.84.059	13 in	6 kΩ	90°	18 in	6	
06.85.594-22	CATERPILLAR®	G3500 series	G13-3, FB77WPCC	06.84.040	15 in	5 kΩ	90°	16 in	1	
06.85.954-16	CATERPILLAR®	G3500 series	G13-3, FB77WPCC	06.84.040	15 in	6 kΩ	90°	16 in	6	
06.85.966-35	CLARK®	TCV-16	GK3-5, RC78PYP	06.84.044	11 in	5 kΩ	180°	24 in	5A	
06.85.1020-24	CLARK®	TCVD12	RW80N	06.84.040	7 in	5 kΩ	90°	24 in	5A	
06.85.1069-20	CLARK®	TCVD12	RW80N	06.84.040	12 in	5 kΩ	90°	20 in	5A	
06.85.505-18	CLARK®	TLA-6	RW80N	06.84.040	11 in	5 kΩ	90°	18 in	5A	
06.85.670-16	COOPER®	GMV series	RW77PP	06.84.040	11 in	5 kΩ	90°	12 in	5A	
06.85.1047-24	COOPER®	GMV series	W80N	06.84.040	5 in	5 kΩ	180°	19 in	5A	
06.85.1084-36	COOPER®	GMVH series	RW80N	06.84.040	7 in	5 kΩ	180°	29 in	5A	
06.85.910-18	COOPER®	LSV-16 (Center Spark Plug)	RW80PP	06.84.040	22 in	5 kΩ	90°	18 in	1	
06.85.958-16	COOPER®	LSV-16 (Center Spark Plug)	RW80PP	06.84.040	22 in	5 kΩ	90°	16 in	5A	
06.85.909-24	COOPER®	LSV-16 (Side Spark Plug)	RW80PP	06.84.040	14 in	5 kΩ	90°	24 in	1	
06.85.957-22	COOPER®	LSV-16 (Side Spark Plug)	RW80PP	06.84.040	14 in	5 kΩ	90°	22 in	5A	
06.85.1071-18	COOPER®	W330 series	B7224	06.84.040	8 in	5 kΩ	90°	18 in	5A	
06.85.1122-18	COOPER®	W330 series	RW80N	06.84.040	8 in	5 kΩ	90°	18 in	5A	
06.85.083-22	CUMMINS®	5.9, GTA 8.3	GK3-5, RC78PYP	06.84.033	6 in	5 kΩ	180°	16 in	4	
06.85.683-18	CUMMINS®	G855	GK3-5, RC78PYP	06.84.044	12 in	5 kΩ	90°	18 in	1	
06.85.1103-18	CUMMINS®	G855	GK3-5, RC78PYP	06.84.044	12 in	5 kΩ	90°	18 in	7	
06.85.675-16	CUMMINS®	GTA14	GK3-5, RC78PYP	06.84.033	10 in	5 kΩ	90°	16 in	4	3394579
06.85.1014-12	CUMMINS®	KTA19GC	GE3-5, RN79G	06.84.059	14 in	5 kΩ	90°	12 in	1	
06.85.1066-12	CUMMINS®	KTA19GC	GE3-5, RN79G	06.84.059	14 in	5 kΩ	90°	12 in	8	2886515, 26364
06.85.1098-18	DELAVAL® (ENTERPRISE®)	HVA series (Center Spark Plug)	B7424	06.84.040	18 in	5 kΩ	90°	18 in	5A	

<sup>1)</sup> For 0 kΩ resistance, please add “-0” to part number (e.g. 06.85.908-22-0).

<sup>2)</sup> Other lengths in 2 in increments available on request. For loose connector and 36 in length add “-K” to part number (e.g. 06.85.908-K)

# Spark Plug Leads & Extensions



## PolyMot™ Spark Plug Leads – for common Applications

P/N	Engine Make	Model	Spark Plug	P/N Silicone Seal Ring	Teflon® Insulator Length	Resistance <sup>1)</sup>	Lead Output from Teflon® Insulator	Ignition Cable Length <sup>2)</sup>	Ignition Coil Connection	Equivalent to
06.85.1098-14	DELAVAL® (ENTERPRISE®)	HVA series (Side Spark Plug)	B7424	06.84.040	18 in	5 kΩ	90°	14 in	5A	
06.85.1068-18	DOOSAN®	GV222TIC	GK3-5, RC78PYP	06.84.033	6 in	5 kΩ	180°	12 in	1	
06.85.835-18	DOOSAN®	GV222TIC	GK3-5, RC78PYP	06.84.033	6 in	6 kΩ	180°	12 in	6	
06.85.528-14	GUASCOR®	SFGLD series	GI3-1, FB77WPCC	06.84.040	11 in	5 kΩ	180°	14 in	1	19.33.500, 19.33.600, BG19.33.500, BG19.33.600, TAE0194
06.85.586-14	GUASCOR®	SFGLD series	GI3-1, FB77WPCC	06.84.040	11 in	5 kΩ	180°	14 in	2	76.64.303, BG76.64.303, TAE0195
06.85.864-26	GUASCOR®	SFGLD series	GI3-1, FB77WPCC	06.84.040	11 in	5 kΩ	180°	14 in	7	76.64.678
06.85.926-20	IVECO®	GE8291SRG75	GK3-5, RC78PYP	06.84.044	10 in	5 kΩ	90°	20 in	1	
06.85.1031-16	LIEBHERR®	G924, G926	B4321	06.84.044	6 in	5 kΩ	180°	10 in	7	
06.85.857-18	LIEBHERR®	G924, G926	GE3-5, RN79G	06.84.059	6 in	5 kΩ	180°	12 in	7	
06.85.487-18	LIEBHERR®	G924, G926	GK3-5, RC78PYP	06.84.033	6 in	5 kΩ	180°	12 in	2	
06.85.873-18	LIEBHERR®	G926TI	GK3-5, RC78PYP	06.84.033	6 in	5 kΩ	180°	12 in	7	
06.85.1037-16	MAN®	E0834E/LE, E0836E	B4321	06.84.044	6 in	5 kΩ	180°	10 in	7	
06.85.709H-18	MAN®	E0834E/LE, E0836E	GK3-5, RC78PYP	06.84.044	6 in	5 kΩ	180°	10 in	1	
06.85.577H-16	MAN®	E0834E/LE, E0836E	GK3-5, RC78PYP	06.84.044	6 in	5 kΩ	180°	10 in	2	
06.85.717H-24	MAN®	E0834E/LE, E0836E	GK3-5, RC78PYP	06.84.044	6 in	6 kΩ	180°	18 in	6	
06.85.839H-16	MAN®	E0834E/LE, E0836E	GK3-5, RC78PYP	06.84.044	6 in	5 kΩ	180°	10 in	7	

<sup>1)</sup> For 0 kΩ resistance, please add “-0” to part number (e.g. 06.85.908-22-0).

<sup>2)</sup> Other lengths in 2 in increments available on request. For loose connector and 36 in length add “-K” to part number (e.g. 06.85.908-K)



5A = ALTRONIC® style; 5B = BENDIX® style; 5C = MOTORTECH; 5E = ALTRONIC® style – CPU XL

# Spark Plug Leads & Extensions

## UNSHIELDED

PolyMot™ Spark Plug Leads – for common Applications

P/N	Engine Make	Model	Spark Plug	P/N Silicone Seal Ring	Teflon® Insulator Length	Resistance <sup>1)</sup>	Lead Output from Teflon® Insulator	Ignition Cable Length <sup>2)</sup>	Ignition Coil Connection	Equivalent to
06.85.988-18	MAN®	E0834E/LE, E0836E	GK3-5, RC78PYP	06.84.044	6 in	5 kΩ	180°	10 in	1A	
06.85.1030-16	MAN®	E0836LE, E28 series	B4321	06.84.044	6 in	5 kΩ	180°	10 in	1	
06.85.1049-16	MAN®	E0836LE, E28 series	B4321	06.84.044	5 in	5 kΩ	180°	11 in	2	
06.85.1031-16	MAN®	E0836LE, E28 series	B4321	06.84.044	6 in	5 kΩ	180°	10 in	7	
06.85.580H-18	MAN®	E0836LE, E28 series	GE3-5, RN79G	06.84.059	6 in	5 kΩ	180°	12 in	1	
06.85.415H-16	MAN®	E0836LE, E28 series	GE3-5, RN79G	06.84.059	6 in	5 kΩ	180°	10 in	2	
06.85.836H-16	MAN®	E0836LE, E28 series	GE3-5, RN79G	06.84.059	6 in	5 kΩ	180°	10 in	7	
06.85.989-18	MAN®	E0836LE, E28 series	GE3-5, RN79G	06.84.059	6 in	5 kΩ	180°	10 in	1A	
06.85.1109-20	MAN®	E26 series	B4321	06.84.044	10 in	5 kΩ	180°	10 in	1	
06.85.1038-20	MAN®	E26 series	B4321	06.84.044	10 in	5 kΩ	180°	10 in	7	
06.85.1082-10	MAN®	E26 series	GK3-5, RC78PYP	06.84.044	10 in	5 kΩ	90°	10 in	7	
06.85.929-20	MAN®	E26 series	GK3-5, RC78PYP	06.84.044	10 in	5 kΩ	180°	10 in	7	
06.85.1005-24	MAN®	E28 series	GL3-5, B8324	06.84.040	7 in	5 kΩ	180°	17 in	1A	
06.85.1120-24	MAN®	E28 series	GL3-5, B8324	06.84.040	7 in	5 kΩ	180°	17 in	2	
06.85.995-24	MAN®	E28 series	GL3-5, B8324	06.84.040	7 in	5 kΩ	180°	17 in	7	
06.85.1050-18	MAN®	E32 series	B4321	06.84.044	8 in	5 kΩ	180°	10 in	1	
06.85.1023-18	MAN®	E32 series	B4321	06.84.044	10 in	5 kΩ	180°	13 in	7	
06.85.1058-18	MAN®	E32 series	GE3-5, RN79G	06.84.059	8 in	5 kΩ	180°	10 in	2	
06.85.959-18	MAN®	E32 series	GE3-5, RN79G	06.84.059	10 in	5 kΩ	180°	13 in	7	
06.85.1042-18	MAN®	E32 series	GL3-5, B8324	06.84.040	10 in	5 kΩ	180°	10 in	7	
06.85.1102-18	MAN®	E32 series with new valve covers <sup>3)</sup>	14R-4DIU3	06.84.044	8 in	5 kΩ	180°	10 in	7	
06.85.1079-18	MAN®	E32 series with new valve covers <sup>3)</sup>	B4321	06.84.044	8 in	5 kΩ	180°	10 in	7	
06.85.1080-18	MAN®	E32 series with new valve covers <sup>3)</sup>	B8324, 18GZ5-77-2	06.84.040	8 in	5 kΩ	180°	10 in	7	
06.85.1073-18	MAN®	E32 series with new valve covers <sup>3)</sup>	GE2-3, FN8xWWCC, 14GZ-LL, 14GZ-LL2	06.84.059	8 in	5 kΩ	180°	10 in	7	
06.85.1106-18	MAN®	E32 series with new valve covers <sup>3)</sup>	GE3-5, 14R-4DIU2, 7315	06.84.059	8 in	5 kΩ	180°	10 in	1	

# Spark Plug Leads & Extensions



## PolyMot™ Spark Plug Leads – for common Applications

P/N	Engine Make	Model	Spark Plug	P/N Silicone Seal Ring	Teflon® Insulator Length	Resistance <sup>1)</sup>	Lead Output from Teflon® Insulator	Ignition Cable Length <sup>2)</sup>	Ignition Coil Connection	Equivalent to
06.85.1078-18	MAN®	E32 series with new valve covers <sup>3)</sup>	GE3-5, 14R-4DIU2, 7315	06.84.059	8 in	5 kΩ	180°	10 in	7	
06.85.1074-18	MAN®	E32 series with new valve covers <sup>3)</sup>	GL3-5, 7308	06.84.040	8 in	5 kΩ	180°	10 in	7	
06.85.1081-14	mitsubishi®	S12R-PTA	B7224	06.84.040	13 in	5 kΩ	90°	14 in	1	
06.85.320H-18	MWM®/DEUTZ®	232, 234 series	GE3-5, RN79G	06.84.059	6 in	5 kΩ	90°	18 in	1	0009 1424
06.85.231	MWM®/DEUTZ®	441 series	GE3-5, RN79G	06.84.059	6 in	5 kΩ	90°	13 in	1	1228 1191
06.85.179-20	MWM®/DEUTZ®	604, 620, 2020 series	GL3-3, RB75WPCC	06.84.040	10 in	5 kΩ	90°	20 in	1	1230 0136
06.85.178-20	MWM®/DEUTZ®	604, 620, 2020 series	GL3-3, RB75WPCC	06.84.040	10 in	5 kΩ	90°	20 in	2	
06.85.998-20	MWM®/DEUTZ®	604, 620, 2020 series	GL3-3, RB75WPCC	06.84.040	10 in	5 kΩ	90°	20 in	7	
06.85.310H-11	MWM®/DEUTZ®	616, 2016 series	GL3-3, RB75WPCC	06.84.040	9 in	5 kΩ	90°	11 in	1	1227 8370
06.85.1070-18	PERKINS®	3000 series	GK3-5, RC78PYP	06.84.044	9 in	5 kΩ	90°	18 in	7	
06.85.479	PERKINS®	4000 series	GI3-3, FB77WPCC	06.84.040	12 in	5 kΩ	180°	13 in	1	
06.85.1072-28	ROLLS ROYCE®	K-Series	GE3-5, RN79G	06.84.059	17 in	5 kΩ	90°	28 in	1	
06.85.271	WÄRTSILÄ®	25SG series	GE3-5, RN79G	06.84.059	17 in	5 kΩ	90°	14 in	4	9150905265
06.85.272	WÄRTSILÄ®	25SG series	GI3-3, FB77WPCC	06.84.040	17 in	5 kΩ	90°	14 in	4	9150904965
06.85.312	WÄRTSILÄ®	25SG series	GI3-3, FB77WPCC	06.84.040	16 in	5 kΩ	90°	14 in	4	
06.85.281	WÄRTSILÄ®	28SG series	GI3-3, FB77WPCC	06.84.040	21 in	5 kΩ	180°	14 in	4	2850905165

<sup>1)</sup> For 0 kΩ resistance, please add “-0” to part number (e.g. 06.85.908-22-0).

<sup>2)</sup> Other lengths in 2 in increments available on request. For loose connector and 36 in length add “-K” to part number (e.g. 06.85.908-K)

<sup>3)</sup> Please also see page 232 for MOTORTECH valve cover conversion kit for recommended retrofitting of already operating engines without safety devices.

## Ignition Coil Connections



5A = ALTRONIC® style; 5B = BENDIX® style; 5C = MOTORTECH; 5E = ALTRONIC® style – CPU XL



# Spark Plug Leads & Extensions

## UNSHIELDED

PolyMot™ Spark Plug Leads – for common Applications

P/N	Engine Make	Model	Spark Plug	P/N Silicone Seal Ring	Teflon® Insulator Length	Resistance <sup>1)</sup>	Lead Output from Teflon® Insulator	Ignition Cable Length <sup>2)</sup>	Ignition Coil Connection	Equivalent to
06.85.306-18	WAUKESHA®	VGF series	GI3-3, FB77WPCC	06.84.040	12 in	5 kΩ	90°	18 in	1	
06.85.326-16	WAUKESHA®	VGF series	GI3-3, FB77WPCC	06.84.040	10 in	5 kΩ	180°	16 in	1	211357S
06.85.429-14	WAUKESHA®	VGF series	GI3-3, FB77WPCC	06.84.040	11 in	5 kΩ	90°	14 in	1	
06.85.357-26	WAUKESHA®	VGF series	GI3-3, FB77WPCC	06.84.040	12 in	5 kΩ	180°	14 in	2	
06.85.423-16	WAUKESHA®	VHP GL series	GT3-1, RM77N	06.84.040	11 in	5 kΩ	90°	16 in	1	
06.85.739-16	WAUKESHA®	VHP GL series	GT3-1, RM77N	06.84.040	9 in	5 kΩ	90°	16 in	1	
06.85.945-16	WAUKESHA®	VHP GL series	GT3-1, RM77N	06.84.040	9 in	6 kΩ	90°	16 in	6	
06.85.649-16	WAUKESHA®	VHP GL series	GT3-1, RM77N	06.84.040	11 in	5 kΩ	90°	24 in	5A	
06.85.993-24	WAUKESHA®	VHP GU series	D14, D14N	06.84.077	13 in	5 kΩ	90°	24 in	1	
06.85.688-16	WAUKESHA®	VHP GU series	GI3-1, FB77WPCC	06.84.040	11 in	5 kΩ	90°	16 in	1	
06.85.422-16	WAUKESHA®	VHP GU series	GT3-1, RM77N	06.84.040	13 in	5 kΩ	90°	16 in	1	211357H
06.85.672H-22	WAUKESHA®	VHP GU/GSI series	GI3-3, FB77WPCC	06.84.040	14 in	5 kΩ	90°	22 in	5A	
06.85.705-16	WAUKESHA®	VHP GU/GSI series	GT3-1, RM77N	06.84.040	12 in	5 kΩ	90°	16 in	1	
06.85.720-18	WAUKESHA®	VHP GU/GSI series	GT3-1, RM77N	06.84.040	12 in	5 kΩ	90°	18 in	1	
06.85.894-18	WAUKESHA®	VHP GU/GSI series	GT3-1, RM77N	06.84.040	14 in	6 kΩ	90°	18 in	6	
06.85.699-16	WAUKESHA®	VHP GU/GSI series	M82N	06.84.040	12 in	5 kΩ	90°	16 in	1	
06.85.848-16	WAUKESHA®	VHP Series Four	GI3-3, FB77WPCC	06.84.040	16 in	5 kΩ	90°	16 in	1	
06.85.1110-20	WAUKESHA®	VHP Series Four	GI3-3, FB77WPCC	06.84.040	16 in	5 kΩ	90°	20 in	1	
06.85.714-24	WAUKESHA®	VHP, ATGL series	GI3-3, FB77WPCC	06.84.040	18 in	5 kΩ	90°	24 in	1	
06.85.678-24	WAUKESHA®	VSG series	GE3-5, RN79G	06.84.059	5 in	5 kΩ	180°	24 in	1	211357D
06.85.667-26	WHITE SUPERIOR®	G825 series	GT3-1, RM77N	06.84.040	8 in	5 kΩ	90°	24 in	1	
06.85.723-24	WHITE SUPERIOR®	GTLB825	D16	06.81.005	6 in	5 kΩ	90°	24 in	1	
06.85.999-14	WORTHINGTON®	MLV (Center Spark Plug)	RW80N	06.84.040	15 in	5 kΩ	90°	14 in	5A	
06.85.1000-14	WORTHINGTON®	MLV (Side Spark Plug)	RW80N	06.84.040	22 in	5 kΩ	90°	14 in	5A	
06.85.913-30	WORTHINGTON®	MLV10 (Center Spark Plug)	RW82P	06.84.040	20 in	5 kΩ	90°	30 in	5A	
06.85.912-24	WORTHINGTON®	MLV10 (Side Spark Plug)	GK3-5, RC78PYP	06.84.044	17 in	5 kΩ	90°	24 in	5A	
06.85.1063-14	WORTHINGTON®	MLV14	RW80N	06.84.040	18 in	5 kΩ	90°	14 in	5A	

<sup>1)</sup> For 0 kΩ resistance, please add “-0” to part number (e.g. 06.85.908-22-0).

<sup>2)</sup> Other lengths in 2 in increments available on request. For loose connector and 36 in length add “-K” to part number (e.g. 06.85.908-K).

# Spark Plug Leads & Extensions



## Silicone Seal Rings for PolyMot™ Spark Plug Leads <sup>1)</sup>

P/N	Description	Fits Spark Plug <sup>2)</sup>	Dimensions			Quantity	Equivalent to
			OD	ID	Height		
06.84.033-100	Silicone seal ring	GK3-5, RC78PYP, B4321	19.0 mm	10.0 mm	12.0 mm	100 pcs	
06.84.034-100	Silicone seal ring	GI3-1, FB77WPCC, B8324	20.0 mm	12.0 mm	15.0 mm	100 pcs	
06.84.038-100	Silicone seal ring	RW80N	20.0 mm	14.4 mm	15.0 mm	100 pcs	
06.84.040-100	Silicone seal ring	GI3-1, FB77WPCC, B8324	20.0 mm	14.0 mm	15.0 mm	100 pcs	
06.84.044-100	Silicone seal ring	GK3-5, RC78PYP, B4321	20.0 mm	10.0 mm	15.0 mm	100 pcs	
06.84.059-100	Silicone seal ring	GE3-5, RN79G	20.0 mm	11.2 mm	15.0 mm	100 pcs	
06.84.077-100	Silicone seal ring	D14, D14N	20.0 mm	13.5 mm	15.0 mm	100 pcs	
06.84.121-100	Silicone seal ring	GK3-5, RC78PYP, B4321	16.0 mm	10.0 mm	11.0 mm	100 pcs	



<sup>1)</sup> Silicone seal rings require replacement every 3000 running hours. See MOTORTECH homepage for appropriate instruction for replacing silicone seal rings.

<sup>2)</sup> Information provided only for comparison purposes.

## Grommet Installation Tool for WAUKESHA® VHP Series Spark Plug Lead

P/N	Description
07.99.016	Grommet installation tool for WAUKESHA® VHP series spark plug leads



## Flange Kit for Spark Plug Leads for WAUKESHA® VHP/ATGL and CATERPILLAR® G3500 Series Gas Engines

P/N	Description
06.51.248	Flange kit for use with P/N 06.85.714-L, 06.85.594-L and 06.85.954-L



## Ignition Coil Connections



5A = ALTRONIC® style; 5B = BENDIX® style; 5C = MOTORTECH; 5E = ALTRONIC® style – CPU XL

# Spark Plug Leads & Extensions

## Spark Plug Leads for CATERPILLAR® G300, G3300 and G3400 Series Gas Engines

The spark plug leads installed by engine manufacturers are not always the best choice when it comes to longevity and trouble-free operation of the engine. Especially for use on CATERPILLAR® G300, G3300 and G3400 series gas engines, MOTORTECH offers suitable spark plug leads for easy replacement of original parts and as an upgrade for every engine. These spark plug leads offer several advantages when being compared to the OEM or aftermarket competition and solve the problems faced by plant operators on regular basis.



### General Features

- Rigid design
- Insulators made of high quality Teflon®
- Reliable ignition coil and spark plug terminals
- Critical high voltage areas are protected with seals
- Designed to match the engine model, the spark plug type and application
- Long life product



### Spark Plug Leads for CATERPILLAR® G300, G3300 and G3400 Series Gas Engines

P/N	Engine Make	Model	Spark Plug	P/N Silicone Seal Ring	Teflon® Insulator Length	Resistance <sup>1)</sup>	Lead Output from Teflon® Insulator	Ignition Cable Length <sup>2)</sup>	Ignition Coil Connection	Equivalent to
06.85.1100-25	CATERPILLAR®	G300 series	RL85G	06.84.059	3.50 in	0 kΩ	180°	20 in	1	
06.85.1100-30	CATERPILLAR®	G300 series	RL85G	06.84.059	3.50 in	0 kΩ	180°	25 in	1	
06.88.009-16	CATERPILLAR®	G3300 series	GE3-5, RN79G	06.84.059	3.75 in	1 kΩ	180°	12 in	1	7W-2479
06.88.010-16	CATERPILLAR®	G3300 series	GE3-5, RN79G	06.84.059	4.25 in	0 kΩ	180°	12 in	2	
06.85.1054-18	CATERPILLAR®	G3400 series	B4321	06.84.044	13.00 in	5 kΩ	90°	18 in	1	
06.85.751-18 <sup>3)</sup>	CATERPILLAR®	G3400 series	GE3-5, RN79G	06.84.059	13.00 in	5 kΩ	90°	18 in	1	262-4855, 250-2149, 217-5922, 9Y-3362, 7W-8542
06.85.939-18	CATERPILLAR®	G3400 series	GE3-5, RN79G	06.84.059	13.00 in	5 kΩ	90°	18 in	5A	
06.85.1019-16	CATERPILLAR®	G3400 series	GE3-5, RN79G	06.84.059	13.00 in	6 kΩ	90°	18 in	6	

<sup>1)</sup> For 0 kΩ resistance, please add “-0” to part number (e.g. 06.85.939-18-0).

<sup>2)</sup> Other lengths in 2 in increments available on request. For loose connector and 36 in length add “-K” to part number (e.g. 06.85.751-K).

<sup>3)</sup> Supersedes 06.88.003-L/-K, 06.85.687-L.

### Ignition Coil Connections



5A = ALTRONIC® style; 5B = BENDIX® style; 5C = MOTORTECH; 5E = ALTRONIC® style – CPU XL

# Spark Plug Leads & Extensions



CATERPILLAR®  
P/N 7W-2479

MOTORTECH  
P/N 06.88.009-16

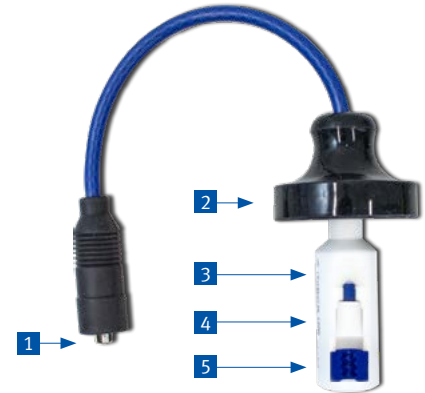

## Spark Plug Lead for CATERPILLAR® G3300 Series – Comparison

- 1 The ignition coil connector features four instead of two contact springs which lead to a more reliable connection. The resistant silicone boot improves the protection against flashovers as well as the stability of the connection with the ignition coil.
- 2 Silicone boot with excellent temperature and aging characteristics for wire output and spark plug well sealing
- 3 Much thicker insulator is made of Teflon® instead of plastic for highest dielectric strength
- 4 Reliable terminal for best spark plug connection
- 5 Integrated silicone seal ring for best flashover protection



CATERPILLAR®  
P/N 250-2149

MOTORTECH  
P/N 06.85.751-18

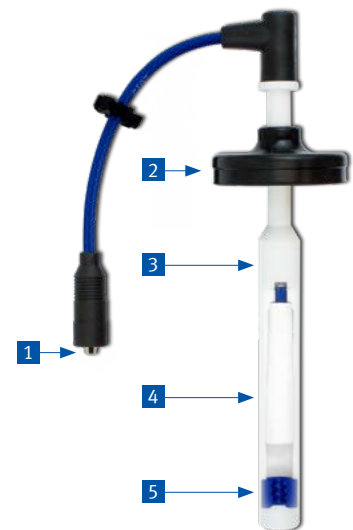

## Spark Plug Lead for CATERPILLAR® G3400 Series – Comparison

- 1 The ignition coil connector features four contact springs which lead to a more reliable connection. The resistant silicone boot improves the protection against flashovers as well as the stability of the connection with the ignition coil.
- 2 Silicone boot with excellent temperature and aging characteristics for wire output and spark plug well sealing. Height-adjustable to compensate length differences of spark plug insulators.
- 3 Much thicker insulator is made of Teflon® instead of plastic for highest dielectric strength
- 4 Ceramic insert with 5 kΩ resistor for EMI suppression and reliable terminal for best spark plug connection
- 5 Integrated silicone seal ring for best flashover protection will not stick on the spark plug insulator when pulling off the Teflon® insulator

# Spark Plug Leads & Extensions

## Spark Plug Leads for **WAUKESHA**<sup>®</sup> ATGL, VGF, VHP and VSG Series Gas Engines

When it comes to longevity and trouble-free operation of an engine, the spark plug leads used by engine manufacturers are not always the best choice. For easy replacement, MOTORTECH offers spark plug leads specially tailored to WAUKESHA's various engine series that solve the problems with which engine operators are regularly confronted.

### General Features

- Rigid design
- Insulators made of high quality Teflon<sup>®</sup>
- Reliable ignition coil and spark plug terminals
- Critical high voltage areas are protected with seals
- Designed to match the engine model, the spark plug type and application
- Long life product



## Spark Plug Leads for **WAUKESHA**<sup>®</sup> ATGL, VGF, VHP and VSG Series Gas Engines

P/N	Engine Make	Model	Spark Plug	P/N Silicone Seal Ring	Teflon <sup>®</sup> Insulator Length	Resistance <sup>1)</sup>	Lead Output from Teflon <sup>®</sup> Insulator	Ignition Cable Length <sup>2)</sup>	Ignition Coil Connection	Equivalent to
06.85.326-16	WAUKESHA <sup>®</sup>	VGF series	GI3-3, FB77WPCC	06.84.040	10 in	5 kΩ	180°	16 in	<b>1</b>	211357S
06.85.429-14	WAUKESHA <sup>®</sup>	VGF series	GI3-3, FB77WPCC	06.84.040	11 in	5 kΩ	90°	14 in	<b>1</b>	06.85.326-16
06.85.423-16	WAUKESHA <sup>®</sup>	VHP GL series	GT3-1, RM77N	06.84.040	11 in	5 kΩ	90°	16 in	<b>1</b>	
06.85.688-16	WAUKESHA <sup>®</sup>	VHP GU series	GI3-1, FB77WPCC	06.84.040	11 in	5 kΩ	90°	16 in	<b>1</b>	
06.85.422-16	WAUKESHA <sup>®</sup>	VHP GU series	GT3-1, RM77N	06.84.040	13 in	5 kΩ	90°	16 in	<b>1</b>	211357H
06.85.1110-20	WAUKESHA <sup>®</sup>	VHP Series Four	GI3-3, FB77WPCC	06.84.040	16 in	5 kΩ	90°	20 in	<b>1</b>	
06.85.714-24	WAUKESHA <sup>®</sup>	VHP, ATGL series	GI3-3, FB77WPCC	06.84.040	18 in	5 kΩ	90°	24 in	<b>1</b>	
06.85.678-24	WAUKESHA <sup>®</sup>	VSG series	GE3-5, RN79G	06.84.059	5 in	5 kΩ	180°	24 in	<b>1</b>	211357D

<sup>1)</sup> For 0 kΩ resistance, please add "-0" to part number (e.g. 06.85.422-16-0).

<sup>2)</sup> Other lengths in 2 in increments available on request. For loose connector and 36 in length add "-K" to part number (e.g. 06.85.326-K).

### Ignition Coil Connections



5A = ALTRONIC<sup>®</sup> style; 5B = BENDIX<sup>®</sup> style; 5C = MOTORTECH; 5E = ALTRONIC<sup>®</sup> style – CPU XL



# ■ Spark Plug Leads & Extensions



WAUKESHA®  
P/N 211357H

MOTORTECH  
P/N 06.85.422-16

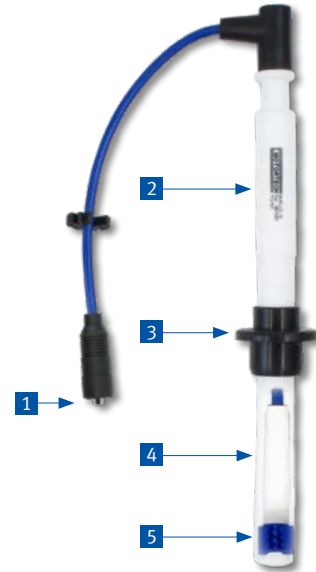
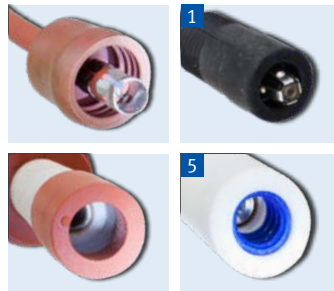

## Spark Plug Lead for WAUKESHA® VHP Series – Comparison

- 1 The ignition coil connector features four contact springs which lead to a more reliable connection. The resistant silicone boot improves the protection against flashovers as well as the stability of the connection with the ignition coil.
- 2 Much thicker insulator is made of high quality Teflon® for highest dielectric strength. The insulator, which is also longer, simplifies access, installation and removal.
- 3 Silicone boot with excellent temperature and aging characteristics for wire output and spark plug well sealing
- 4 Ceramic insert with 5 kΩ resistor for EMI suppression and reliable terminal for best spark plug connection
- 5 Integrated silicone seal ring for best flashover protection will not stick on the spark plug insulator when pulling off the Teflon® insulator

## Grommet Installation Tool for WAUKESHA® VHP Series Spark Plug Lead

With this practical tool, the grommet can easily be brought into the correct position after the spark plug lead has been installed in order to seal the spark plug shaft in the best possible way.

P/N	Description
07.99.016	Grommet installation tool for WAUKESHA® VHP series spark plug leads





# Spark Plug Leads & Extensions

## UNSHIELDED

### Spark Plug Leads for common Applications (Non PolyMot™ Style)

P/N	Engine Make	Model	Spark Plug	P/N Silicone Seal Ring	Insulator Length	Resistance <sup>1)</sup>	Lead Output from Insulator	Ignition Cable Length <sup>2)</sup>	Ignition Coil Connection	Equivalent to
06.85.697-20	AJAX®	230	GT3-1, RM77N	06.84.040	5 in	0 kΩ	90°	20 in	1	
06.85.698-30	AJAX®	230	GT3-1, RM77N	06.84.040	5 in	0 kΩ	90°	30 in	5A	
06.85.773-15	AJAX®	230	GT3-1, RM77N	06.84.034	5 in	0 kΩ	90°	15 in	5A	
06.85.719-16	AJAX®	230	W18	06.81.017	5 in	0 kΩ	90°	16 in	1	
06.85.860-16	ARROW®	VRG176, VRG220, VRG330	J6C, J8C	06.84.059	5 in	1 kΩ	90°	14 in	6	
06.85.514-16	CLARK®	TLA-6	RW80N	06.84.038	8 in	0 kΩ	90°	16 in	5A	
06.85.1117-34	COOPER®	GMVH series	RW78N	06.84.040	5 in	0 kΩ	90°	34 in	5A	
06.85.1046-16	CUMMINS®	G/GTA 5.9	GK3-5, RC78PYP		4 in	0 kΩ	180°	12 in	8	4090567, 26354
06.85.903-22	CUMMINS®	GTA 8.3	GK3-5, RC78PYP		5 in	5 kΩ	180°	17 in	8	4989132
06.85.1062-16	CUMMINS®	ISL G280	GK3-5, RC78PYP	06.84.121	6 in	5 kΩ	180°	10 in	7	
06.85.1119-20	CUMMINS®	K38	GK3-5, RC78PYP		11 in	5 kΩ	180°	9 in	1	
06.85.1107-16	CUMMINS®	NT855-GA	PFR7B-D	06.84.121	14 in	5 kΩ	90°	16 in	1	
06.85.1108-24	CUMMINS®	NTA855	GK3-5, RC78PYP	06.84.121	13 in	5 kΩ	90°	24 in	1	
06.85.730-10	DEUTZ®	1015, 2015 series	B4321, 14GZ6-77-2		7 in	6 kΩ	90°	10 in	6	0426 9082
06.85.949-10	DEUTZ®	1015, 2015 series	B4321, 14GZ6-77-2	06.84.033	9 in	6 kΩ	90°	10 in	6	06.85.730-10
06.88.015-48	INGERSOLL RAND®	KVSR12	RW80N	06.84.040	4 in	0 kΩ	180°	14 in	5A	
06.85.1044-27	INGERSOLL RAND®	TVR10	RW83F	06.84.040	4 in	0 kΩ	180°	23 in	5A	
06.85.964-20	LIEBHERR®	G9408	GK3-5, RC78PYP	06.81.071	6 in	5 kΩ	180°	14 in	2	
06.85.1052-24	SCANIA®	DC12	GK3-5, RC78PYP	06.84.121	11 in	5 kΩ	90°	24 in	7	
06.85.697-20	WAUKESHA®	F1197G	GT3-1, RM77N	06.84.040	11 in	0 kΩ	90°	20 in	1	
06.85.695-24	WHITE SUPERIOR®	G825 series	D14N	06.84.040	8 in	0 kΩ	90°	24 in	5A	
06.85.690-24	WHITE SUPERIOR®	G825 series	GK3-5, RC78PYP	06.84.044	5 in	0 kΩ	90°	24 in	1	
06.85.1095-24	WHITE SUPERIOR®	G825 series	RD16, RD18Y	06.84.040	8 in	0 kΩ	90°	24 in	1	
06.85.689-24	WHITE SUPERIOR®	G825 series (lean burn)	GK3-5, RC78PYP	06.84.044	8 in	0 kΩ	90°	24 in	1	

<sup>1)</sup> For 0 kΩ resistance, please add “-0” to part number (e.g. 06.85.949-10-0).

<sup>2)</sup> Other lengths in 2 in increments available on request. For loose connector and 36 in length add “-K” to part number (e.g. 06.85.697-K).

### Ignition Coil Connections



5A = ALTRONIC® style; 5B = BENDIX® style; 5C = MOTORTECH; 5E = ALTRONIC® style – CPU XL

# Spark Plug Leads & Extensions



## Spark Plug Lead Kits

P/N	Engine Make	Model	Spark Plug	Number of included Leads	Insulator Length	Resistance	Lead Output from Insulator	Ignition Coil Connection
06.85.1006	ARROW®	VR330CF	GE3-5, RN79G	6	5 in	6 kΩ	180°	6
06.85.952 <sup>1)</sup>	GM®	V8	GK3-5, RC78PYP	8	4 in	0 kΩ	180°	4
06.85.379 <sup>2)</sup>	MAN®	E2866 E302	GE3-5, RN79G	6	5 in	6 kΩ	180°	6
06.85.380 <sup>2)</sup>	MAN®	E2842 E302	GE3-5, RN79G	12	5 in	6 kΩ	180°	6

<sup>1)</sup> Spark plug lead kit includes connecting leads from ignition coil to distributor.

<sup>2)</sup> Spark plug lead kits include distributor caps and connecting leads from ignition coil to distributor

## Unshielded Safety Leads for Shielded Spark Plugs

P/N <sup>1)</sup>	SP Termination Well Depth	Spark Plug End	Ignition Coil End	Inductive Pickup Spacer	5 kΩ Resistor	Ignition Coil	Equivalent to
09.02.1000-L	2.125 in	180°	180°			291001-S, 501061-S, 591010-S	USL2A-"L"A, AWH81-"L"
09.02.1001-L	2.125 in	90°	180°			291001-S, 501061-S, 591010-S	USL2LA-"L"A, USLY2LA-"L"A
09.02.1001-24	2.125 in	90°	180°			291001-S, 501061-S, 591010-S	USL2LA-24A, USLY2LA-24A, BM-11422-C
09.02.1001-30	2.125 in	90°	180°			291001-S, 501061-S, 591010-S	USL2LA-30A, USLY2LA-30A, BM-11422-B
09.02.1010-L	2.125 in	180°	90°			291001-S, 501061-S, 591010-S	USL2AL-"L"A
09.02.1011-L	2.125 in	90°	90°			291001-S, 501061-S, 591010-S	USL2LAL-"L"A
09.02.1100-L	2.125 in	180°	180°	x		291001-S, 501061-S, 591010-S	USL2A-"L"AIPS
09.02.1101-L	2.125 in	90°	180°	x		291001-S, 501061-S, 591010-S	USL2LA-"L"AIPS
09.02.1110-L	2.125 in	180°	90°	x		291001-S, 501061-S, 591010-S	USL2AL-"L"AIPS
09.02.1111-L	2.125 in	90°	90°	x		291001-S, 501061-S, 591010-S	USL2LAL-"L"AIPS
09.02.1200-L	2.125 in	180°	180°		x	291001-S, 501061-S, 591010-S	RSL2A-"L"A
09.02.1201-L	2.125 in	90°	180°		x	291001-S, 501061-S, 591010-S	RSL2LA-"L"A
09.02.1210-L	2.125 in	180°	90°		x	291001-S, 501061-S, 591010-S	RSL2AL-"L"A
09.02.1211-L	2.125 in	90°	90°		x	291001-S, 501061-S, 591010-S	RSL2LAL-"L"A
09.02.1300-L	2.125 in	180°	180°	x	x	291001-S, 501061-S, 591010-S	RSL2A-"L"AIPS
09.02.1301-L	2.125 in	90°	180°	x	x	291001-S, 501061-S, 591010-S	RSL2LA-"L"AIPS
09.02.1310-L	2.125 in	180°	90°	x	x	291001-S, 501061-S, 591010-S	RSL2AL-"L"AIPS
09.02.1311-L	2.125 in	90°	90°	x	x	291001-S, 501061-S, 591010-S	RSL2LAL-"L"AIPS
09.02.2000-L	2.125 in	180°	180°			10-320790-1, 10-382040-1	USL2B-"L"A, AWH22-"L"
09.02.2001-L	2.125 in	90°	180°			10-320790-1, 10-382040-1	USL2LB-"L"A
09.02.2010-L	2.125 in	180°	90°			10-320790-1, 10-382040-1	USL2BL-"L"A
09.02.2011-L	2.125 in	90°	90°			10-320790-1, 10-382040-1	USL2LBL-"L"A
09.02.2100-L	2.125 in	180°	180°	x		10-320790-1, 10-382040-1	USL2B-"L"AIPS
09.02.2101-L	2.125 in	90°	180°	x		10-320790-1, 10-382040-1	USL2LB-"L"AIPS
09.02.2110-L	2.125 in	180°	90°	x		10-320790-1, 10-382040-1	USL2BL-"L" AIPS
09.02.2111-L	2.125 in	90°	90°	x		10-320790-1, 10-382040-1	USL2LBL-"L"AIPS
09.02.2200-L	2.125 in	180°	180°		x	10-320790-1, 10-382040-1	RSL2B-"L"A
09.02.2201-L	2.125 in	90°	180°		x	10-320790-1, 10-382040-1	RSL2LA-"L"A
09.02.2210-L	2.125 in	180°	90°		x	10-320790-1, 10-382040-1	RSL2AL-"L"A
09.02.2211-L	2.125 in	90°	90°		x	10-320790-1, 10-382040-1	RSL2LAL-"L"A
09.02.2300-L	2.125 in	180°	180°	x	x	10-320790-1, 10-382040-1	RSL2B-"L"AIPS
09.02.2301-L	2.125 in	90°	180°	x	x	10-320790-1, 10-382040-1	RSL2LB-"L"AIPS

<sup>1)</sup> Standard lead lengths (-L) = 12 in, 18 in, 24 in, 30 in, 36 in; other lengths available on request. Consult factory for other configurations.

# Spark Plug Leads & Extensions

## Unshielded Safety Leads for Shielded Spark Plugs

P/N <sup>1)</sup>	SP Termination Well Depth	Spark Plug End	Ignition Coil End	Inductive Pickup Spacer	5 kΩ Resistor	Ignition Coil	Equivalent to
09.02.2310-L	2.125 in	90°	90°	x	x	10-320790-1, 10-382040-1	RSL2LBL-"L"AIPS
09.02.2311-L	2.125 in	180°	90°	x	x	10-320790-1, 10-382040-1	RSL2BL-"L"AIPS
09.02.3000-L	2.125 in	180°	180°			PPT2477AD, PPT2477AD-L	USL2C-"L"A, AWH42-"L"
09.02.3001-L	2.125 in	90°	180°			PPT2477AD, PPT2477AD-L	USL2LC-"L"A
09.02.3010-L	2.125 in	180°	90°			PPT2477AD, PPT2477AD-L	USL2CL-"L"A
09.02.3011-L	2.125 in	90°	90°			PPT2477AD, PPT2477AD-L	USL2LCL-"L"A
09.02.3100-L	2.125 in	180°	180°	x		PPT2477AD, PPT2477AD-L	USL2C-"L"AIPS
09.02.3101-L	2.125 in	90°	180°	x		PPT2477AD, PPT2477AD-L	USL2LC-"L"AIPS
09.02.3110-L	2.125 in	180°	90°	x		PPT2477AD, PPT2477AD-L	USL2CL-"L"AIPS
09.02.3111-L	2.125 in	90°	90°	x		PPT2477AD, PPT2477AD-L	USL2LCL-"L"AIPS
09.02.3200-L	2.125 in	180°	180°		x	PPT2477AD, PPT2477AD-L	RSL2C-"L"A
09.02.3201-L	2.125 in	90°	180°		x	PPT2477AD, PPT2477AD-L	RSL2LC-"L"A
09.02.3210-L	2.125 in	180°	90°		x	PPT2477AD, PPT2477AD-L	RSL2CL-"L"A
09.02.3211-L	2.125 in	90°	90°		x	PPT2477AD, PPT2477AD-L	RSL2LCL-"L"A
09.02.3300-L	2.125 in	180°	180°	x	x	PPT2477AD, PPT2477AD-L	RSL2C-"L"AIPS
09.02.3301-L	2.125 in	90°	180°	x	x	PPT2477AD, PPT2477AD-L	RSL2LC-"L"AIPS
09.02.3310-L	2.125 in	180°	90°	x	x	PPT2477AD, PPT2477AD-L	RSL2CL-"L"AIPS
09.02.3311-L	2.125 in	90°	90°	x	x	PPT2477AD, PPT2477AD-L	RSL2LCL-"L"AIPS
09.02.4000-L	2.125 in	180°	180°			291001, 501061, 591010	USL2E-"L"A, AWH72-"L"
09.02.4001-L	2.125 in	90°	180°			291001, 501061, 591010	USL2LE-"L"A, USLY2LE-"L"A
09.02.4001-12	2.125 in	90°	180°			291001, 501061, 591010	USL2LE-12A, USLY2LE-12A, BM-11422-G
09.02.4001-15	2.125 in	90°	180°			291001, 501061, 591010	USL2LE-15A, USLY2LE-15A, BM-11422-F
09.02.4001-24	2.125 in	90°	180°			291001, 501061, 591010	USL2LE-24A, USLY2LE-24A, BM-11422-E
09.02.4100-L	2.125 in	180°	180°	x		291001, 501061, 591010	USL2E-"L"AIPS
09.02.4101-L	2.125 in	90°	180°	x		291001, 501061, 591010	USL2LE-"L"AIPS
09.02.4110-L	2.125 in	180°	180°	x		291001, 501061, 591010	USL2E-"L"A w. 06.80.261
09.02.4200-L	2.125 in	180°	180°		x	291001, 501061, 591010	RSL2E-"L"A
09.02.4201-L	2.125 in	90°	180°		x	291001, 501061, 591010	RSL2LE-"L"A
09.02.4300-L	2.125 in	180°	180°	x	x	291001, 501061, 591010	RSL2E-"L"AIPS
09.02.4301-L	2.125 in	90°	180°	x	x	291001, 501061, 591010	RSL2LE-"L"AIPS
09.02.5000-L	2.125 in	180°	180°			PPT2477P, PPT2477L	USL2F-"L"A, AWH82-"L"
09.02.5001-L	2.125 in	90°	180°			PPT2477P, PPT2477L	USL2LF-"L"A
09.02.5100-L	2.125 in	180°	180°	x		PPT2477P, PPT2477L	USL2F-"L"AIPS
09.02.5101-L	2.125 in	90°	180°	x		PPT2477P, PPT2477L	USL2LF-"L"AIPS
09.02.5200-L	2.125 in	180°	180°		x	PPT2477P, PPT2477L	RSL2F-"L"A
09.02.5201-L	2.125 in	90°	180°		x	PPT2477P, PPT2477L	RSL2LF-"L"A
09.02.5300-L	2.125 in	180°	180°	x	x	PPT2477P, PPT2477L	RSL2F-"L"AIPS
09.02.5301-L	2.125 in	90°	180°	x	x	PPT2477P, PPT2477L	RSL2LF-"L"AIPS
09.02.7000-L	2.125 in	180°	180°			Unshielded in Coil Box inst.	USL2G-"L"A, AWH62-"L"
09.02.7001-L	2.125 in	90°	180°			Unshielded in Coil Box inst.	USL2LG-"L"A
09.02.7100-L	2.125 in	180°	180°	x		Unshielded in Coil Box inst.	USL2G-"L"AIPS
09.02.7101-L	2.125 in	90°	180°	x		Unshielded in Coil Box inst.	USL2LG-"L"AIPS
09.02.7200-L	2.125 in	180°	180°		x	Unshielded in Coil Box inst.	RSL2G-"L"A
09.02.7201-L	2.125 in	90°	180°		x	Unshielded in Coil Box inst.	RSL2LG-"L"A
09.02.7300-L	2.125 in	180°	180°	x	x	Unshielded in Coil Box inst.	RSL2G-"L"AIPS
09.02.7301-L	2.125 in	90°	180°	x	x	Unshielded in Coil Box inst.	RSL2-LG-"L"AIPS

<sup>1)</sup> Standard lead lengths (-L) = 12 in, 18 in, 24 in, 30 in, 36 in; other lengths available on request. Consult factory for other configurations.

# Spark Plug Leads & Extensions



## Unshielded Safety Leads for Conventional Spark Plugs

P/N <sup>1)</sup>	Fits max. Ceramic Diameter	Spark Plug End	Ignition Coil End	Inductive Pickup Spacer	5 kΩ Resistor	Ignition Coil	Equivalent to
09.03.1000-L	0.485 in	180°	180°			291001-S, 501061-S, 591010-S	USLA14SPB-“L”A
09.03.4000-L	0.485 in	180°	180°			291001, 501061, 591010	USLE14SPB-“L”A
09.04.1000-L	0.560 in	180°	180°			291001-S, 501061-S, 591010-S	USLA18SPB-“L”A
09.04.4000-L	0.560 in	180°	180°			291001, 501061, 591010	USLE18SPB-“L”A
09.05.1000-L	0.485 in	180°	180°			291001-S, 501061-S, 591010-S	USLA35SPB-“L”A
09.05.4000-L	0.485 in	180°	180°			291001, 501061, 591010	USLE35SPB-“L”A
09.06.1000-L	0.545 in	180°	180°			291001-S, 501061-S, 591010-S	USLA36SPB-“L”A
09.06.4000-L	0.545 in	180°	180°			291001, 501061, 591010	USLE36SPB-“L”A
09.07.1000-L	0.385 in	180°	180°			291001-S, 501061-S, 591010-S	USLA45SPB-“L”A
09.07.4000-L	0.385 in	180°	180°			291001, 501061, 591010	USLE45SPB-“L”A
09.08.1000-L	0.470 in	180°	180°			291001-S, 501061-S, 591010-S	USLA51SPB-“L”A
09.08.4000-L	0.470 in	180°	180°			291001, 501061, 591010	USLE51SPB-“L”A
09.09.1000-L	0.580 in	180°	180°			291001-S, 501061-S, 591010-S	USLA78SPB-“L”A
09.09.2000-L	0.580 in	180°	180°			10-320790-1, 10-382040-1	USLB78SPB-“L”A
09.09.4000-L	0.580 in	180°	180°			291001, 501061, 591010	USLE78SPB-“L”A
09.10.1000-L	Silicone Boot	180°	180°			291001-S, 501061-S, 591010-S	USLASB180-“L”A
09.10.2000-L	Silicone Boot	180°	180°			10-320790-1, 10-382040-1	USLSB180-“L”A
09.10.3000-L	Silicone Boot	180°	180°			PPT2477AD, PPT2477ADL	USLCSB180-“L”A
09.10.4000-L	Silicone Boot	180°	180°			291001, 501061, 591010	USLESB180-“L”A
09.11.1000-L	Silicone Boot	90°	180°			291001-S, 501061-S, 591010-S	USLASL90-“L”A
09.11.2000-L	Silicone Boot	90°	180°			10-320790-1, 10-382040-1	USLSL90-“L”A
09.11.3000-L	Silicone Boot	90°	180°			PPT2477AD, PPT2477ADL	USLCSL90-“L”A
09.11.4000-L	Silicone Boot	90°	180°			291001, 501061, 591010	USLESL90-“L”A
09.12.1000-L	Terminal	90°	180°			291001-S, 501061-S, 591010-S	USLA18T22-“L”A
09.12.2000-L	Terminal	90°	180°			10-320790-1, 10-382040-1	USLB18T22-“L”A
09.12.3000-L	Terminal	90°	180°			PPT2477AD, PPT2477ADL	USLC18T22-“L”A
09.12.4000-L	Terminal	90°	180°			291001, 501061, 591010	USLE18T22-“L”A
09.13.1000-L	Terminal	180°	180°			291001-S, 501061-S, 591010-S	USLA18T33-“L”A
09.13.2000-L	Terminal	180°	180°			10-320790-1, 10-382040-1	USLB18T33-“L”A
09.13.3000-L	Terminal	180°	180°			PPT2477AD, PPT2477ADL	USLC18T33-“L”A
09.13.4000-L	Terminal	180°	180°			291001, 501061, 591010	USLE18T33-“L”A

<sup>1)</sup> Standard lead lengths (-L) = 12 in, 18 in, 24 in, 30 in, 36 in; other lengths available on request. Consult factory for other configurations.

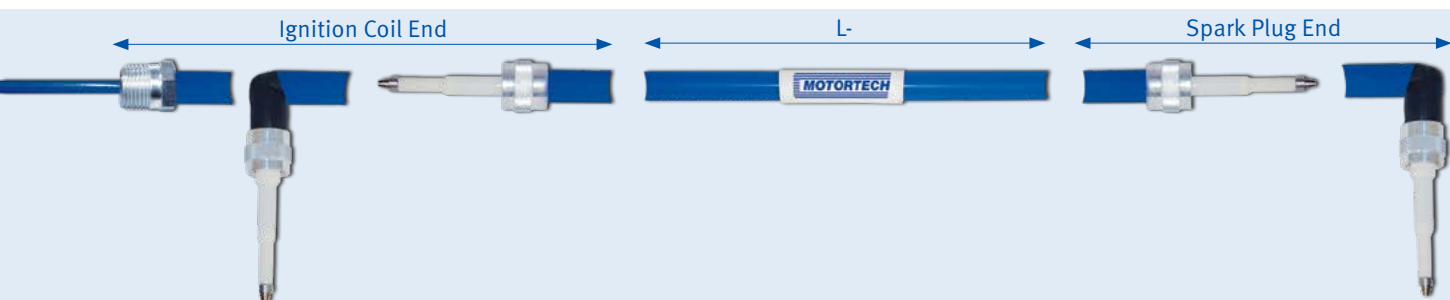

Conversion: 1 inch = 25.4 mm / 1 foot = 0.3 m

# ■ Spark Plug Leads & Extensions

## Accessories for Unshielded Spark Plug Leads

### Ignition Cables – Nickel Plated Copper Wire

P/N	Figure	Description	Color	Equivalent to
02.85.757	1	Ignition cable, 7 mm silicone, 17-19 strands, 100 ft spool	blue	5419-100
02.85.758 <sup>1)</sup>	2	Ignition cable, 7 mm silicone, 17-19 strands, 100 ft spool	orange	757, 5419-151

<sup>1)</sup> Ignition cable with stainless steel wire available on special request.

### Silicone Hoses

P/N	Figure	Description	Outer Diameter	Color	Equivalent to
02.85.965-82	3	Silicone hose, 8x2 mm, 82 ft spool	12 mm	blue	21606
02.85.865-82	3	Silicone hose, 8x2 mm, 82 ft spool	12 mm	orange	
02.85.914-82	3	Silicone hose, 12x1.5 mm, 82 ft spool	15 mm	blue	SO-5
02.85.814-82	3	Silicone hose, 12x1.5 mm, 82 ft spool	15 mm	orange	

### Inductive Pickup Spacer

P/N	Figure	Description	Position	Quantity	Equivalent to
06.84.010-100	4	Inductive pickup spacer	end of lead	100 pcs	
06.84.043-100	5	Inductive pickup spacer	middle of lead	100 pcs	

### Spark Plug Connectors (for 14 mm Spark Plugs only)

P/N	Figure	Description	Quantity	Equivalent to
06.84.024-100	6	Spark plug connector, 90°, silicone, for use with 7 mm ignition cable, including terminal P/N 02.85.920	100 pcs	ST-22XL
06.84.025-100	7	Spark plug connector, 180°, silicone, for use with 7 mm ignition cable, including terminal P/N 02.85.920	100 pcs	ST-33XL



Conversion: 1 inch = 25.4 mm / 1 foot = 0.3 m

# Spark Plug Leads & Extensions



## Spark Plug Boots

P/N	Figure	Description	Quantity	Equivalent to
06.84.008-100	8	Spark plug boot, 90°, silicone, for use with 7 mm ignition cable and terminal P/N 22.85.803	100 pcs	
06.84.009-100	9	Spark plug boot, 180°, silicone, for use with 7 mm ignition cable and terminal P/N 22.85.802	100 pcs	W54883

## Terminals for Spark Plug Connectors and Boots

P/N	Figure	Description	Quantity	Equivalent to
02.85.920-100	10	Terminal, for use with spark plug connectors P/N 06.84.024 and P/N 06.84.025	100 pcs	D-199
22.85.802-100	11	Terminal, for use with spark plug boot P/N 06.84.009	100 pcs	
22.85.803-100	12	Terminal, for use with spark plug boot P/N 06.84.008	100 pcs	5419-150

## Silicone Boot

P/N	Figure	Description	Quantity	Equivalent to
02.99.004-100	13	Silicone boot, 90°	100 pcs	

## Spark Plug Connectors

P/N	Figure	Description	Quantity	Equivalent to
02.85.924-100	14	Spark plug connector, 90°, for use with 7 mm ignition cable	100 pcs	T-22, 21459
02.85.925-100	15	Spark plug connector, 180°, for use with 7 mm ignition cable	100 pcs	T-33, 21418

## Ignition Coil Connectors

P/N	Figure	Description	Quantity	Equivalent to
06.80.261-100	16	Ignition coil connector, 180°, 0 kΩ resistance, requires crimp terminal P/N 06.80.126	100 pcs	
22.80.009-100	17	Ignition coil connector, 90°, 1 kΩ resistance, requires crimp terminal P/N 06.80.126	100 pcs	
06.80.091-100 <sup>1)</sup>	18	Ignition coil connector, 180°, 0 kΩ resistance, requires crimp terminal P/N 06.80.126	100 pcs	

<sup>1)</sup> For ignition coils with positive secondary termination.





# ■ Spark Plug Leads & Extensions

## Crimp Terminals

P/N	Figure	Description	Quantity	Equivalent to
06.80.012-100	1	Crimp terminal, 180°, for use with spreading adaptor P/N 02.85.1012	100 pcs	
06.80.116-100	2	Crimp terminal, 90°, for use with MOTORTECH Style ignition coils	100 pcs	
06.80.116-180-100	3	Crimp terminal, 180°, for use with New MOTORTECH Style ignition coils	100 pcs	
06.80.108-100	4	Crimp terminal base, for use with crimp terminals P/N 06.80.116-100 and P/N 06.80.116-180-100	100 pcs	
06.80.126-100	5	Crimp terminal base, for use ignition coil terminals P/N 06.80.261 and P/N 22.80.009	100 pcs	

## Spreading Adaptor

P/N	Figure	Supersedes	Description	Quantity	Equivalent to
02.85.1012-100	6	02.85.1004-100	Spreading adaptor for ALTRONIC® Style ignition coils	100 pcs	

## Distance Collars

P/N	Figure	Description	Quantity	Equivalent to
06.86.001-100	7	Distance collar, for use with 7 mm ignition cable	100 pcs	
06.86.002-100	8	Distance collar, for use with 7 mm ignition cable	100 pcs	
06.86.003-100	9	Distance collar, for use with 7 mm ignition cable	100 pcs	
06.86.005-100	10	Distance collar, for use with 7 mm ignition cable	100 pcs	



# Spark Plug Leads & Extensions



## Silicone Seal Rings for Spark Plug Leads <sup>1)</sup>

P/N	Figure	Description	Fits Spark Plug <sup>2)</sup>	Dimensions			Quantity	Equivalent to
				OD	ID	Height		
06.84.033-100	11	Silicone seal ring	GK3-5, RC78PYP, B4321	19.0 mm	10.0 mm	12.0 mm	100 pcs	
06.84.034-100	11	Silicone seal ring	GI3-1, FB77WPCC, B8324	20.0 mm	12.0 mm	15.0 mm	100 pcs	
06.84.038-100	11	Silicone seal ring	RW80N	20.0 mm	14.4 mm	15.0 mm	100 pcs	
06.84.040-100	11	Silicone seal ring	GI3-1, FB77WPCC, B8324	20.0 mm	14.0 mm	15.0 mm	100 pcs	
06.84.044-100	11	Silicone seal ring	GK3-5, RC78PYP, B4321	20.0 mm	10.0 mm	15.0 mm	100 pcs	
06.84.059-100	11	Silicone seal ring	GE3-5, RN79G	20.0 mm	11.2 mm	15.0 mm	100 pcs	
06.84.077-100	11	Silicone seal ring	D14, D14N	20.0 mm	13.5 mm	15.0 mm	100 pcs	
06.84.121-100	11	Silicone seal ring	GK3-5, RC78PYP, B4321	16.0 mm	10.0 mm	11.0 mm	100 pcs	

<sup>1)</sup> Silicone seal rings require replacement every 3000 running hours. See MOTORTECH homepage for appropriate instruction for replacing silicone seal rings.

<sup>2)</sup> Information provided only for comparison purposes.

## Grommet for CUMMINS® Ignition Coils

P/N	Figure	Description	Color	Quantity	Equivalent to
06.84.053-100	12	Grommet, for use with CUMMINS® 8.3 ignition coil	black	100 pcs	3973945

## Silicone Seal for ALTRONIC®, BG®, CUMMINS® and WAUKESHA® Spark Plug Extensions

P/N	Figure	Description	Color	Quantity	Equivalent to
06.84.049-100	13	Silicone seal, for 18 mm spark plug extension	blue	100 pcs	740011

## Grommet for MOTORTECH Spark Plug Leads for WAUKESHA® VHP Series Gas Engines

P/N	Figure	Description	Color	Quantity	Equivalent to
06.80.039-25	14	Grommet for MOTORTECH spark plug leads, WAUKESHA® VHP series gas engines	black	25 pcs	

## Silicone Boot for WÄRTSILÄ® 25SG Series Spark Plug Leads

P/N	Figure	Description	Color	Equivalent to
06.84.011	15	Silicone boot for WÄRTSILÄ® 25SG series spark plug leads	black	9150902801

## Silicone Seal Ring for CATERPILLAR® G3400 Series Gas Engines

P/N	Figure	Description	Color	Equivalent to
06.84.090	16	Silicone seal ring for spark plug well, CATERPILLAR® G3400 series gas engines	black	7E-0079



Accessories for Unshielded Spark Plug Leads

# Spark Plug Leads & Extensions

SHIELDED

## MOT-Blues

SHIELDED SPARK PLUG LEADS

### MOT-Blues Shielded Spark Plug Leads for Externally Mounted Ignition Coils

There is an alternative to the commonly failing conventional shielded spark plug leads. MOTORTECH has designed a CSA approved shielded spark plug lead for Class I, Division 2, Group D that will perform better than the industry standard. There is no need to convert to unshielded when you cannot keep the engine running with the conventional leads.



MOT-Blues Shielded Spark Plug Lead



Conventional Shielded Spark Plug Lead



The MOT-Blues ignition cable is specially designed for shielded CSA certified spark plug leads. It consists of a multi layer design:

- Nickel plated copper core
- 2 layers of silicone
- Stainless steel braid
- Silicone jacket

This design ensures that no humidity can be trapped in the lead.



# Spark Plug Leads & Extensions



## MOTORTECH Style – 1-20 UNEF Ignition Coil Termination – 1 in Spark Plug Termination Well Depth

P/N <sup>1)</sup>	Description	Spark Plug Termination Well Depth <sup>2)</sup>	Spark Plug Termination	Ignition Coil Termination	Equivalent to
95.91.020-10	MOT-Blues shielded spark plug lead	1 in	3/4-20 UNEF, 180°	1-20 UNEF, 180°	A755-10, HT1400-10, SL1400-10, 5419-220, 95.85.020-10
95.91.020-13	MOT-Blues shielded spark plug lead	1 in	3/4-20 UNEF, 180°	1-20 UNEF, 180°	A755-13, HT1400-13, SL1400-13, 5419-221, 95.85.020-13
95.91.020-16	MOT-Blues shielded spark plug lead	1 in	3/4-20 UNEF, 180°	1-20 UNEF, 180°	A755-16, HT1400-16, SL1400-16, 5419-222, 95.85.020-16
95.91.020-18	MOT-Blues shielded spark plug lead	1 in	3/4-20 UNEF, 180°	1-20 UNEF, 180°	A755-18, HT1400-18, SL1400-18, 5419-223, 95.85.020-18
95.91.020-20	MOT-Blues shielded spark plug lead	1 in	3/4-20 UNEF, 180°	1-20 UNEF, 180°	A755-20, HT1400-20, SL1400-20, 95.85.020-20
95.91.020-21	MOT-Blues shielded spark plug lead	1 in	3/4-20 UNEF, 180°	1-20 UNEF, 180°	A755-21, HT1400-21, SL1400-21, 95.85.020-21
95.91.020-22	MOT-Blues shielded spark plug lead	1 in	3/4-20 UNEF, 180°	1-20 UNEF, 180°	A755-22, HT1400-22, SL1400-22, 95.85.020-22
95.91.020-24	MOT-Blues shielded spark plug lead	1 in	3/4-20 UNEF, 180°	1-20 UNEF, 180°	A755-24, HT1400-24, SL1400-24, 95.85.020-24
95.91.020-30	MOT-Blues shielded spark plug lead	1 in	3/4-20 UNEF, 180°	1-20 UNEF, 180°	A755-30, HT1400-30, SL1400-30, 95.85.020-30
95.91.020-35	MOT-Blues shielded spark plug lead	1 in	3/4-20 UNEF, 180°	1-20 UNEF, 180°	A755-35, HT1400-35, SL1400-35, 95.85.020-35

<sup>1)</sup> Standard lead lengths; other lengths available on request.

<sup>2)</sup> Spark plug leads with 1 in spark plug termination well depth only available on special request.

All terminals made of ceramic. HEX-nut on spark plug side.



## MOTORTECH Style – 1-20 UNEF Ignition Coil Termination – 2 in Spark Plug Termination Well Depth

P/N <sup>1)</sup>	Description	Spark Plug Termination Well Depth	Spark Plug Termination	Ignition Coil Termination	Equivalent to
95.91.030-10	MOT-Blues shielded spark plug lead	2 in	3/4-20 UNEF, 180°	1-20 UNEF, 180°	A755-10-2, HT2400-10, SL2400-10, 5419-230, 95.85.030-10
95.91.030-13	MOT-Blues shielded spark plug lead	2 in	3/4-20 UNEF, 180°	1-20 UNEF, 180°	A755-13-2, HT2400-13, SL2400-13, 5419-231, 95.85.030-13
95.91.030-16	MOT-Blues shielded spark plug lead	2 in	3/4-20 UNEF, 180°	1-20 UNEF, 180°	A755-16-2, HT2400-16, SL2400-16, 5419-232, 95.85.030-16
95.91.030-18	MOT-Blues shielded spark plug lead	2 in	3/4-20 UNEF, 180°	1-20 UNEF, 180°	A755-18-2, HT2400-18, SL2400-18, 5419-233, 95.85.030-18
95.91.030-20	MOT-Blues shielded spark plug lead	2 in	3/4-20 UNEF, 180°	1-20 UNEF, 180°	A755-20-2, HT2400-20, SL2400-20, 95.85.030-20
95.91.030-21	MOT-Blues shielded spark plug lead	2 in	3/4-20 UNEF, 180°	1-20 UNEF, 180°	A755-21-2, HT2400-21, SL2400-21, 95.85.030-21
95.91.030-22	MOT-Blues shielded spark plug lead	2 in	3/4-20 UNEF, 180°	1-20 UNEF, 180°	A755-22-2, HT2400-22, SL2400-22, 95.85.030-22
95.91.030-24	MOT-Blues shielded spark plug lead	2 in	3/4-20 UNEF, 180°	1-20 UNEF, 180°	A755-24-2, HT2400-24, SL2400-24, 95.85.030-24
95.91.030-30	MOT-Blues shielded spark plug lead	2 in	3/4-20 UNEF, 180°	1-20 UNEF, 180°	A755-30-2, HT2400-30, SL2400-30, 95.85.030-30
95.91.030-35	MOT-Blues shielded spark plug lead	2 in	3/4-20 UNEF, 180°	1-20 UNEF, 180°	A755-35-2, HT2400-35, SL2400-35, 95.85.030-35

<sup>1)</sup> Standard lead lengths; other lengths available on request.

All terminals made of ceramic. HEX-nut on spark plug side.

# Spark Plug Leads & Extensions

SHIELDED



## ALTRONIC® Style – 3/4-20 UNEF Ignition Coil Termination – 1 in Spark Plug Termination Well Depth

P/N <sup>1)</sup>	Description	Spark Plug Termination Well Depth <sup>2)</sup>	Spark Plug Termination	Ignition Coil Termination	Equivalent to
95.90.020-10	MOT-Blues shielded spark plug lead	1 in	3/4-20 UNEF, 180°	3/4-20 UNEF, 180°	593020-10, 593121-10, HT1300-10, SL1300-10, SSL-A1-10A, 5419-200, 95.80.020-10
95.90.020-13	MOT-Blues shielded spark plug lead	1 in	3/4-20 UNEF, 180°	3/4-20 UNEF, 180°	593020-13, 593121-13, HT1300-13, SL1300-13, SSL-A1-13A, 5419-201, BM-11422-A-13, A593020-13, 178790, 95.80.020-13
95.90.020-16	MOT-Blues shielded spark plug lead	1 in	3/4-20 UNEF, 180°	3/4-20 UNEF, 180°	593020-16, 593121-16, HT1300-16, SL1300-16, SSL-A1-16A, 5419-202, 2867092, 95.80.020-16
95.90.020-18	MOT-Blues shielded spark plug lead	1 in	3/4-20 UNEF, 180°	3/4-20 UNEF, 180°	593020-18, 593121-18, HT1300-18, SL1300-18, SSL-A1-18A, 5419-203, 169533H, 95.80.020-18
95.90.020-20	MOT-Blues shielded spark plug lead	1 in	3/4-20 UNEF, 180°	3/4-20 UNEF, 180°	593020-20, 593121-20, HT1300-20, SL1300-20, SSL-A1-20A, 95.80.020-20
95.90.020-21	MOT-Blues shielded spark plug lead	1 in	3/4-20 UNEF, 180°	3/4-20 UNEF, 180°	593020-21, 593121-21, HT1300-21, SL1300-21, SSL-A1-21A, 95.80.020-21
95.90.020-22	MOT-Blues shielded spark plug lead	1 in	3/4-20 UNEF, 180°	3/4-20 UNEF, 180°	593020-22, 593121-22, HT1300-22, SL1300-22, SSL-A1-22A, 95.80.020-22
95.90.020-24	MOT-Blues shielded spark plug lead	1 in	3/4-20 UNEF, 180°	3/4-20 UNEF, 180°	593020-24, 593121-24, HT1300-24, SL1300-24, SSL-A1-24A, 95.80.020-24
95.90.020-30	MOT-Blues shielded spark plug lead	1 in	3/4-20 UNEF, 180°	3/4-20 UNEF, 180°	593020-30, 593121-30, HT1300-30, SL1300-30, SSL-A1-30A, 95.80.020-30
95.90.020-35	MOT-Blues shielded spark plug lead	1 in	3/4-20 UNEF, 180°	3/4-20 UNEF, 180°	593020-35, 593121-35, HT1300-35, SL1300-35, SSL-A1-35A, 95.80.020-35

<sup>1)</sup> Standard lead lengths; other lengths available on request.

<sup>2)</sup> Spark plug leads with 1 in spark plug termination well depth only available on special request.

All terminals made of ceramic. HEX-nut on spark plug side.



## ALTRONIC® Style – 3/4-20 UNEF Ignition Coil Termination – 2 in Spark Plug Termination Well Depth

P/N <sup>1)</sup>	Description	Spark Plug Termination Well Depth	Spark Plug Termination	Ignition Coil Termination	Equivalent to
95.90.030-10	MOT-Blues shielded spark plug lead	2 in	3/4-20 UNEF, 180°	3/4-20 UNEF, 180°	593030-10, 593131-10, HT2300-10, SL2300-10, SSL-A2-10A, 5419-210, 95.80.030-10
95.90.030-13	MOT-Blues shielded spark plug lead	2 in	3/4-20 UNEF, 180°	3/4-20 UNEF, 180°	593030-13, 593131-13, HT2300-13, SL2300-13, SSL-A2-13A, 5419-211, 95.80.030-13
95.90.030-16	MOT-Blues shielded spark plug lead	2 in	3/4-20 UNEF, 180°	3/4-20 UNEF, 180°	593030-16, 593131-16, HT2300-16, SL2300-16, SSL-A2-16A, 5419-212, 95.80.030-16
95.90.030-18	MOT-Blues shielded spark plug lead	2 in	3/4-20 UNEF, 180°	3/4-20 UNEF, 180°	593030-18, 593131-18, HT2300-18, SL2300-18, SSL-A2-18A, 5419-213, 209424, 95.80.030-18
95.90.030-20	MOT-Blues shielded spark plug lead	2 in	3/4-20 UNEF, 180°	3/4-20 UNEF, 180°	593030-20, 593131-20, HT2300-20, SL2300-20, SSL-A2-20A, 95.80.030-20
95.90.030-21	MOT-Blues shielded spark plug lead	2 in	3/4-20 UNEF, 180°	3/4-20 UNEF, 180°	593030-21, 593131-21, HT2300-21, SL2300-21, SSL-A2-21A, 95.80.030-21
95.90.030-22	MOT-Blues shielded spark plug lead	2 in	3/4-20 UNEF, 180°	3/4-20 UNEF, 180°	593030-22, 593131-22, HT2300-22, SL2300-22, SSL-A2-22A, 95.80.030-22
95.90.030-24	MOT-Blues shielded spark plug lead	2 in	3/4-20 UNEF, 180°	3/4-20 UNEF, 180°	593030-24, 593131-24, HT2300-24, SL2300-24, SSL-A2-24A, 95.80.030-24
95.90.030-30	MOT-Blues shielded spark plug lead	2 in	3/4-20 UNEF, 180°	3/4-20 UNEF, 180°	593030-30, 593131-30, HT2300-30, SL2300-30, SSL-A2-30A, 95.80.030-30
95.90.030-35	MOT-Blues shielded spark plug lead	2 in	3/4-20 UNEF, 180°	3/4-20 UNEF, 180°	593030-35, 593131-35, HT2300-35, SL2300-35, SSL-A2-35A, 95.80.030-35

<sup>1)</sup> Standard lead lengths; other lengths available on request.

All terminals made of ceramic. HEX-nut on spark plug side.

# Spark Plug Leads & Extensions



## Conventional Shielded Spark Plug Leads for Externally Mounted Ignition Coils

MOTORTECH Style – 1-20 UNEF Ignition Coil Termination – 1 in Spark Plug Termination Well Depth



P/N <sup>1)</sup>	Description	Spark Plug Termination Well Depth <sup>2)</sup>	Spark Plug Termination	Ignition Coil Termination	Equivalent to
95.85.020-10	Shielded spark plug lead	1 in	3/4-20 UNEF, 180°	1-20 UNEF, 180°	A755-10, HT1400-10, 5419-220
95.85.020-13	Shielded spark plug lead	1 in	3/4-20 UNEF, 180°	1-20 UNEF, 180°	A755-13, HT1400-13, 5419-221
95.85.020-16	Shielded spark plug lead	1 in	3/4-20 UNEF, 180°	1-20 UNEF, 180°	A755-16, HT1400-16, 5419-222
95.85.020-18	Shielded spark plug lead	1 in	3/4-20 UNEF, 180°	1-20 UNEF, 180°	A755-18, HT1400-18, 5419-223
95.85.020-20	Shielded spark plug lead	1 in	3/4-20 UNEF, 180°	1-20 UNEF, 180°	A755-20, HT1400-20
95.85.020-21	Shielded spark plug lead	1 in	3/4-20 UNEF, 180°	1-20 UNEF, 180°	A755-21, HT1400-21
95.85.020-22	Shielded spark plug lead	1 in	3/4-20 UNEF, 180°	1-20 UNEF, 180°	A755-22, HT1400-22
95.85.020-24	Shielded spark plug lead	1 in	3/4-20 UNEF, 180°	1-20 UNEF, 180°	A755-24, HT1400-24
95.85.020-30	Shielded spark plug lead	1 in	3/4-20 UNEF, 180°	1-20 UNEF, 180°	A755-30, HT1400-30
95.85.020-35	Shielded spark plug lead	1 in	3/4-20 UNEF, 180°	1-20 UNEF, 180°	A755-35, HT1400-35

<sup>1)</sup> Standard lead lengths; other lengths available on request.

<sup>2)</sup> Spark plug leads with 1 in spark plug termination well depth only available on special request.

All terminals made of ceramic. HEX-nut on spark plug side.

MOTORTECH Style – 1-20 UNEF Ignition Coil Termination – 2 in Spark Plug Termination Well Depth



P/N <sup>1)</sup>	Description	Spark Plug Termination Well Depth	Spark Plug Termination	Ignition Coil Termination	Equivalent to
95.85.030-10	Shielded spark plug lead	2 in	3/4-20 UNEF, 180°	1-20 UNEF, 180°	A755-10-2, HT2400-10, 5419-230
95.85.030-13	Shielded spark plug lead	2 in	3/4-20 UNEF, 180°	1-20 UNEF, 180°	A755-13-2, HT2400-13, 5419-231
95.85.030-16	Shielded spark plug lead	2 in	3/4-20 UNEF, 180°	1-20 UNEF, 180°	A755-16-2, HT2400-16, 5419-232
95.85.030-18	Shielded spark plug lead	2 in	3/4-20 UNEF, 180°	1-20 UNEF, 180°	A755-18-2, HT2400-18, 5419-233
95.85.030-20	Shielded spark plug lead	2 in	3/4-20 UNEF, 180°	1-20 UNEF, 180°	A755-20-2, HT2400-20
95.85.030-21	Shielded spark plug lead	2 in	3/4-20 UNEF, 180°	1-20 UNEF, 180°	A755-21-2, HT2400-21
95.85.030-22	Shielded spark plug lead	2 in	3/4-20 UNEF, 180°	1-20 UNEF, 180°	A755-22-2, HT2400-22
95.85.030-24	Shielded spark plug lead	2 in	3/4-20 UNEF, 180°	1-20 UNEF, 180°	A755-24-2, HT2400-24
95.85.030-30	Shielded spark plug lead	2 in	3/4-20 UNEF, 180°	1-20 UNEF, 180°	A755-30-2, HT2400-30
95.85.030-35	Shielded spark plug lead	2 in	3/4-20 UNEF, 180°	1-20 UNEF, 180°	A755-35-2, HT2400-35

<sup>1)</sup> Standard lead lengths; other lengths available on request.

All terminals made of ceramic. HEX-nut on spark plug side.

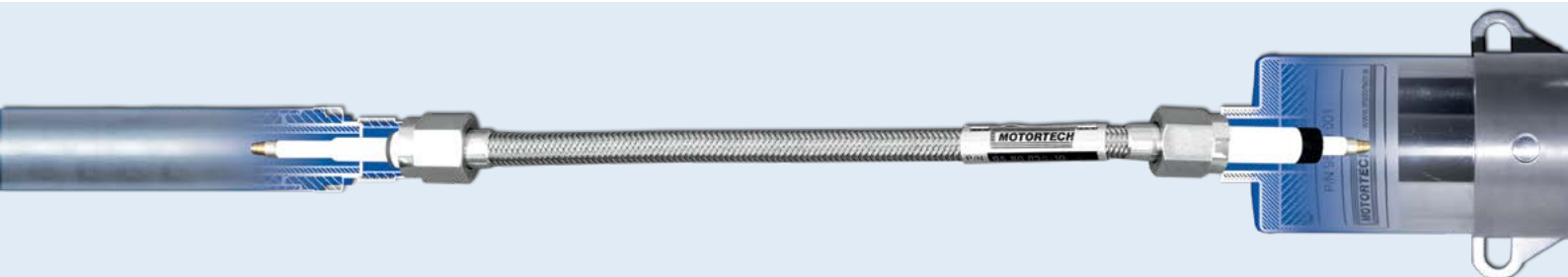



# ■ Spark Plug Leads & Extensions

## ALTRONIC® Style – 3/4-20 UNEF Ignition Coil Termination – 1 in Spark Plug Termination Well Depth



P/N <sup>1)</sup>	Description	Spark Plug Termination Well Depth <sup>2)</sup>	Spark Plug Termination	Ignition Coil Termination	Equivalent to
95.80.020-10	Shielded spark plug lead	1 in	3/4-20 UNEF, 180°	3/4-20 UNEF, 180°	593020-10, HT1300-10, SSL-A1-10A, 5419-200
95.80.020-13	Shielded spark plug lead	1 in	3/4-20 UNEF, 180°	3/4-20 UNEF, 180°	593020-13, HT1300-13, SSL-A1-13A, 5419-201, BM-11422-A-13, A593020-13, 178790
95.80.020-16	Shielded spark plug lead	1 in	3/4-20 UNEF, 180°	3/4-20 UNEF, 180°	593020-16, HT1300-16, SSL-A1-16A, 5419-202, 2867092
95.80.020-18	Shielded spark plug lead	1 in	3/4-20 UNEF, 180°	3/4-20 UNEF, 180°	593020-18, HT1300-18, SSL-A1-18A, 5419-203, 169533H
95.80.020-20	Shielded spark plug lead	1 in	3/4-20 UNEF, 180°	3/4-20 UNEF, 180°	593020-20, HT1300-20, SSL-A1-20A
95.80.020-21	Shielded spark plug lead	1 in	3/4-20 UNEF, 180°	3/4-20 UNEF, 180°	593020-21, HT1300-21, SSL-A1-21A
95.80.020-22	Shielded spark plug lead	1 in	3/4-20 UNEF, 180°	3/4-20 UNEF, 180°	593020-22, HT1300-22, SSL-A1-22A
95.80.020-24	Shielded spark plug lead	1 in	3/4-20 UNEF, 180°	3/4-20 UNEF, 180°	593020-24, HT1300-24, SSL-A1-24A
95.80.020-30	Shielded spark plug lead	1 in	3/4-20 UNEF, 180°	3/4-20 UNEF, 180°	593020-30, HT1300-30, SSL-A1-30A
95.80.020-35	Shielded spark plug lead	1 in	3/4-20 UNEF, 180°	3/4-20 UNEF, 180°	593020-35, HT1300-35, SSL-A1-35A

<sup>1)</sup> Standard lead lengths; other lengths available on request.

<sup>2)</sup> Spark plug leads with 1 in spark plug termination well depth only available on special request.

All terminals made of ceramic. HEX-nut on spark plug side.

## ALTRONIC® Style – 3/4-20 UNEF Ignition Coil Termination – 2 in Spark Plug Termination Well Depth



P/N <sup>1)</sup>	Description	Spark Plug Termination Well Depth	Spark Plug Termination	Ignition Coil Termination	Equivalent to
95.80.030-10	Shielded spark plug lead	2 in	3/4-20 UNEF, 180°	3/4-20 UNEF, 180°	593030-10, HT2300-10, SSL-A2-10A, 5419-210
95.80.030-13	Shielded spark plug lead	2 in	3/4-20 UNEF, 180°	3/4-20 UNEF, 180°	593030-13, HT2300-13, SSL-A2-13A, 5419-211
95.80.030-16	Shielded spark plug lead	2 in	3/4-20 UNEF, 180°	3/4-20 UNEF, 180°	593030-16, HT2300-16, SSL-A2-16A, 5419-212
95.80.030-18	Shielded spark plug lead	2 in	3/4-20 UNEF, 180°	3/4-20 UNEF, 180°	593030-18, HT2300-18, SSL-A2-18A, 5419-213, 209424
95.80.030-20	Shielded spark plug lead	2 in	3/4-20 UNEF, 180°	3/4-20 UNEF, 180°	593030-20, HT2300-20, SSL-A2-20A
95.80.030-21	Shielded spark plug lead	2 in	3/4-20 UNEF, 180°	3/4-20 UNEF, 180°	593030-21, HT2300-21, SSL-A2-21A
95.80.030-22	Shielded spark plug lead	2 in	3/4-20 UNEF, 180°	3/4-20 UNEF, 180°	593030-22, HT2300-22, SSL-A2-22A
95.80.030-24	Shielded spark plug lead	2 in	3/4-20 UNEF, 180°	3/4-20 UNEF, 180°	593030-24, HT2300-24, SSL-A2-24A
95.80.030-30	Shielded spark plug lead	2 in	3/4-20 UNEF, 180°	3/4-20 UNEF, 180°	593030-30, HT2300-30, SSL-A2-30A
95.80.030-35	Shielded spark plug lead	2 in	3/4-20 UNEF, 180°	3/4-20 UNEF, 180°	593030-35, HT2300-35, SSL-A2-35A

<sup>1)</sup> Standard lead lengths; other lengths available on request.

All terminals made of ceramic. HEX-nut on spark plug side.

# Spark Plug Leads & Extensions



## Terminal Repair Kits for Shielded and Unshielded Spark Plug Leads

### Kits for MOT-Blues **Shielded** Spark Plug Leads

P/N	Description	Stud Thread Size	Adaptor	Equivalent to
02.85.1006	Terminal kit, spark plug sided	M3	3/4-20 UNEF, 2 in termination well depth <sup>1)</sup>	
02.85.1007	Terminal kit, ignition coil sided	M3	3/4-20 UNEF, ALTRONIC® Style	
02.85.1008	Terminal kit, ignition coil sided	M3	1-20 UNEF, MOTORTECH Style	

<sup>1)</sup> Consult factory for terminal kits to fit spark plugs with 3/4-20 UNEF thread and 1 in termination well depth.

### Kits for Conventional **Shielded** Spark Plug Leads

P/N	Description	Stud Thread Size	Adaptor	Equivalent to <sup>1)</sup>
02.85.991	Terminal kit, spark plug sided	M3	3/4-20 UNEF, 1 in termination well depth	SC1K, 504205
02.85.992	Terminal kit, spark plug sided	M3	3/4-20 UNEF, 2 in termination well depth	SC2K, 504137
02.85.992-1	Terminal kit, ignition coil sided	M3	3/4-20 UNEF, BENDIX® Style	
02.85.996	Terminal kit, ignition coil sided	M3	3/4-20 UNEF, ALTRONIC® Style	ALTSS-2
02.85.997	Terminal kit, ignition coil sided	M3	1-20 UNEF, MOTORTECH Style	

<sup>1)</sup> Please note that the thread size differs from the competition. For the repair of spark plug leads, all components from the above mentioned repair kits must be used.

### Kits for **Unshielded** Spark Plug Leads

P/N	Description	Stud Thread Size	Adaptor	Equivalent to <sup>1)</sup>
02.85.993	Terminal kit, ignition coil sided	M3	3/4-20 UNEF, ALTRONIC® Style	ALTOS-1, 510480
02.85.994	Terminal kit, ignition coil sided	M3	3/4-20 UNEF, BENDIX® Style	BENDOS-1
02.85.995	Terminal kit, ignition coil sided	M3	1-20 UNEF, MOTORTECH Style	FMOS-1

<sup>1)</sup> Please note that the thread size differs from the competition. For the repair of spark plug leads, all components from the above mentioned repair kits must be used.



# ■ Spark Plug Leads & Extensions

UNSHIELDED



## PolyMot™ Spark Plug Extensions

Besides all the successful spark plug leads, MOTORTECH has also designed a large number of spark plug extensions under the PolyMot™ design. These extensions are unique and offer several advantages when being compared to the OEM or aftermarket competition. With the knowledge gathered in ignition control and ignition coil research and manufacturing, a lot of the details were implemented into these products. The unique structure has achieved tremendous reliability records in the field.

### General Features

- Rigid design
- Extensions made of high quality Teflon® and up to 36 inch length
- Ceramic insert with 5 kΩ resistor for EMI suppression (0 kΩ available on request)
- Reliable ignition coil and spark plug terminal
- Critical high voltage areas are protected with seals
- Designed to match the engine model, the spark plug type and application
- Extensions are labeled with P/N and production code for easy traceability
- Top thread for easy removal with special tool
- Long life product

### Key Design Features

- 1 Spring-loaded secondary terminal rod to ignition coil
- 2 Special O-ring made of Viton® with excellent temperature and aging characteristics for best protection of ignition coil secondary terminal
- 3 Large thread on top end for easy removal with special tool P/N 44.99.912
- 4 Highest dielectric strength due to Teflon® insulator
- 5 Ceramic insert with 5 kΩ resistor for EMI suppression
- 6 Integrated silicone seal rings for best flashover protection will not stick on the spark plug insulator when pulling off the extension



P/N 44.99.912 Removal Tool

# Spark Plug Leads & Extensions



## PolyMot™ Spark Plug Extensions for common Applications

P/N <sup>1)</sup>	Supersedes	Engine Make	Model	Teflon® Insulator Length	Resistance	Spark Plug	P/N Silicone Seal Ring	Thread on Top End	Equivalent to
06.80.320-T	06.80.320, 06.80.320H, 06.80.320H-T, 06.80.381H, 06.80.381H-T	CATERPILLAR®	G3500 series	11 in	5 kΩ	GI3-3, FB77WPCC, B8324/-LTN	06.84.040	x	123-4710, 25080-04, 5419-806
06.80.319-T	06.80.319, 06.80.319H, 06.80.319H-T	CATERPILLAR®	G3600 series	11 in	5 kΩ	GI3-3, FB77WPCC, B8324/-LTN	06.84.040	x	207-4509, 207-4508, 123-8641, 25080-03, 5419-805
06.80.202-T	06.80.202	COOPER®	2400G series	9 in	5 kΩ	GI3-3, FB77WPCC, B8324/-LTN	06.84.040		656-701-003, 25080-02, 5419-801
06.80.755-T <sup>2)</sup>		CUMMINS®	QSK60G	13 in	5 kΩ	GI3-3, FB77WPCC, B8324/-LTN	06.84.040	x	
06.80.756-T <sup>2)</sup>		CUMMINS®	QSV81/91G	15 in	5 kΩ	GI3-3, FB77WPCC, B8324/-LTN	06.84.040	x	
06.80.1134 <sup>3)</sup>		WÄRTSILÄ®	28SG series	19 in	5 kΩ	GI3-4, FB77WPCC, B8324/-LTN	06.84.040	x	
06.80.1132 <sup>3)</sup>		WÄRTSILÄ®	34SG series	23 in	5 kΩ	GI3-4, FB77WPCC, B8324/-LTN	06.84.040	x	
06.80.471-T		WAUKESHA®	275GL+ series	15 in	5 kΩ	GI3-3, FB77WPCC, B8324/-LTN	06.84.040	x	A296064J, A296064K, 26400-10, 26510-10
06.80.469-T		WAUKESHA®	APG series	10 in	5 kΩ	GI3-3, FB77WPCC, B8324/-LTN	06.84.040	x	A211797M, A211797T, 25080-10, 26400-08, 26510-08
06.80.206-T	06.80.206	WAUKESHA®	AT25GL series	15 in	5 kΩ	GT3-1, RM77N, B8124	06.84.040	x	A211357L, A211357N, A211357T, A211357Y, A296805A, 26400-02, 26510-02, 25080-09, 5419-802
06.80.330-T	06.80.330	WAUKESHA®	AT25GL-LR series	15 in	5 kΩ	GI3-3, FB77WPCC, B8324/-LTN	06.84.040	x	A211357R, A211357V, A211357Z, A296805, 25080-08, 26400-04, 26510-04, 5419-808
06.80.213-T	06.80.213	WAUKESHA®	AT27GL series	15 in	5 kΩ	GT3-1, RM77N, B8124	06.84.040	x	296064B, 296064C, A296064C, A296064E, A296064G, 25080-11, 26400-03, 26510-03
06.80.310-T	06.80.310	WAUKESHA®	AT27GL-LR series	14 in	5 kΩ	GI3-3, FB77WPCC, B8324/-LTN	06.84.040	x	296064D, 296064F, 296064H, A296064D, A296064F, A296064H, A296064L, 25080-07, 26400-05, 26510-05, 5419-804
06.80.309-T	06.80.309	WAUKESHA®	VGF series	9 in	5 kΩ	GI3-3, FB77WPCC, B8324/-LTN	06.84.040	x	A211357X, A211797J, A211797K, A211797S, 25080-01, 26400-07, 26510-07, 5419-803
06.80.340-T	06.80.340	WAUKESHA®	VHP-4 series	13 in	5 kΩ	GI3-3, FB77WPCC, B8324/-LTN	06.84.040	x	211797A, A211797G, 25080-06, 26510-06, 5419-735
06.80.321-T	06.80.321, 06.80.321H, 06.80.321H-T	WAUKESHA®	VHP-GL series	13 in	5 kΩ	GI3-3, FB77WPCC, B8324/-LTN	06.84.040	x	211357P, 211357U, A211797H, A211797P, A211797R, 25080-05, 25080-12, 26400-01, 26510-01, 5419-807

<sup>1)</sup> For 0 kΩ resistance, please add “0” to part number (e.g. 06.80.320-T-0).

<sup>2)</sup> Fits application only, if conversion kits P/N 75.30.143 (CUMMINS® QSK60G) or 75.30.144 (CUMMINS® QSV81/91G) previously were used.

<sup>3)</sup> Fits application only, if conversion kits P/N 75.30.154 (WÄRTSILÄ® 28SG) or 75.30.155 (WÄRTSILÄ® 34SG) previously were used.

## Removal Tool for Spark Plug Extensions with Thread on Top End

P/N	Supersedes	Description	Equivalent to
44.99.912		Spark plug extension removal tool	

# ■ Spark Plug Leads & Extensions

## Ignition Coil Extensions

For **MOTORTECH/CATERPILLAR®** Ignition Coils – For **CATERPILLAR®** G3520C/E and G3600 Series Gas Engines

P/N	Figure	Description	Application	Resistance	Teflon® Insulator		Fits Ignition Coil P/N	Equivalent to
					Length	Diameter		
06.80.459H <sup>1)</sup>	<b>1</b>	Ignition coil extension	G3520C/E, G3600	0 kΩ	248 mm	26 mm	06.50.161, 06.50.162, 283-5270	308-1380, 283-5271, 264-5323, 150-2050
06.80.600	<b>2</b>	Ignition coil extension	G3520C/E, G3600	0 kΩ	252 mm	26 mm	06.50.164, 06.50.165	

<sup>1)</sup> Supersedes ignition coil extensions P/N 06.80.375H and 06.80.446H.

For **MOTORTECH/CATERPILLAR®** Ignition Coils – For **CATERPILLAR®** GCM34 Series Gas Engines

P/N	Figure	Description	Application	Resistance	Teflon® Insulator		Fits Ignition Coil P/N	Equivalent to
					Length	Diameter		
06.80.1013-T	<b>3</b>	Ignition coil extension	GCM34	5 kΩ	530 mm	26 mm	193-468157, 258-4893, 06.50.170	263210167, 3400.7-21.07.02-03
06.80.602	<b>4</b>	Ignition coil extension	GCM34	5 kΩ	534 mm	26 mm	06.50.174, 06.50.175	

For **CATERPILLAR®** Ignition Coils

P/N	Figure	Description	Teflon® Insulator		Equivalent to
			Length	Diameter	
06.80.356H	<b>5</b>	Ignition coil extension	118 mm	25 mm	133-5078
06.80.360H	<b>5</b>	Ignition coil extension	118 mm	30 mm	169-4295

For **WÄRTSILÄ®** 34SG Series Gas Engines

P/N	Description	Application	Resistance	Teflon® Insulator		Fits Ignition Coil P/N	Equivalent to
				Length	Diameter		
06.80.460	Ignition coil extension	34SG series	5 kΩ	460 mm	26 mm		0012E002200
06.80.461	Ignition coil extension	34SG series	5 kΩ	446 mm	26 mm		0012E006500

Please consult factory for availability of ignition coil extensions for 220G/SG series gas engines (P/N 3340063 and 3341380)



# Spark Plug Leads & Extensions



## Ignition Coil Extension Overhaul Kits

Kits for **MOTORTECH** Ignition Coils – For **CATERPILLAR®** G3400/C and G3500/B/C/E/H Series Gas Engines

P/N	Figure	Description	Application	Teflon® Insulator		Fits Ignition Coil P/N
				Length	Diameter	
06.80.741	6	Extension overhaul kit	G3400 – Non CSA	95 mm	30 mm	06.50.141, 06.50.145
06.80.742	6	Extension overhaul kit	G3400 – CSA	97 mm	30 mm	06.50.142, 06.50.146
06.80.743	6	Extension overhaul kit	G3400 – Non CSA	107 mm	30 mm	06.50.143, 06.50.147
06.80.744	6	Extension overhaul kit	G3400 – CSA	109 mm	30 mm	06.50.144, 06.50.148
06.80.751	6	Extension overhaul kit	G3500 – Non CSA	118 mm	30 mm	06.50.151, 06.50.155
06.80.752	6	Extension overhaul kit	G3500 – CSA	105 mm	30 mm	06.50.152, 06.50.156
06.80.753	6	Extension overhaul kit	G3500 – Non CSA	112 mm	30 mm	06.50.153, 06.50.157
06.80.754	6	Extension overhaul kit	G3500 – CSA	105 mm	30 mm	06.50.154, 06.50.158
06.80.764	6	Extension overhaul kit	G3500 – Non CSA	104 mm	25 mm	06.50.159, 06.50.160

Above Overhaul Kits contain following Subcomponents

P/N	P/N Teflon® Insulator including Seal Ring	P/N included Silicone Seal Ring	P/N included Insulator Seal	P/N Lip Seal Ring <sup>1)</sup>	P/N Secondary Terminal
06.80.741	06.80.741-2	06.84.059		06.81.051 7	02.85.881 8
06.80.742	06.80.742-2	06.84.059	06.81.084	06.81.051 7	06.51.134 8
06.80.743	06.80.743-2	06.84.059		06.81.051 7	06.51.136 8
06.80.744	06.80.744-2	06.84.059	06.81.084	06.81.051 7	06.51.133 8
06.80.751	06.80.751-2	06.84.040		06.81.051 7	02.85.881 8
06.80.752	06.80.752-2	06.84.040	06.81.084	06.81.051 7	02.85.870 8
06.80.753	06.80.753-2	06.84.040		06.81.051 7	02.85.881 8
06.80.754	06.80.754-2	06.84.040	06.81.084	06.81.051 7	02.85.870 8
06.80.764	06.80.764-2	06.84.040		06.81.051 7	02.85.870 8

<sup>1)</sup> Lip seal ring P/N 06.81.051 equivalent to P/N 135-2651.





# Spark Plug Leads & Extensions

Kits for **CATERPILLAR®** Ignition Coils – For **CATERPILLAR®** G3400/C and G3500/B Series Gas Engines

P/N	Figure	Supersedes	Description	Application	Teflon® Insulator		Fits Ignition Coil P/N
					Length	Diameter	
06.80.419H	<a href="#">1</a>		Extension overhaul kit	G3400 – Non CSA	95 mm	30 mm	232-6348, 165-1591, 131-3277, 129-8802, 108-0615
06.80.742	<a href="#">1</a>	06.80.418H	Extension overhaul kit	G3400 – CSA	97 mm	30 mm	232-6349, 165-1592, 122-8070
06.80.420H	<a href="#">1</a>		Extension overhaul kit	G3400 – Non CSA	107 mm	30 mm	232-6352, 213-7443
06.80.744	<a href="#">1</a>	06.80.417H	Extension overhaul kit	G3400 – CSA	109 mm	30 mm	232-6353, 213-7444
06.80.515H	<a href="#">1</a>	06.80.315H	Extension overhaul kit	G3500 – Non CSA	118 mm	30 mm	232-6346, 165-1589, 124-0749
06.80.752	<a href="#">1</a>	06.80.415H	Extension overhaul kit	G3500 – CSA	105 mm	30 mm	232-6347, 165-1590
06.80.480	<a href="#">1</a>		Extension overhaul kit	G3500 – Non CSA	112 mm	30 mm	232-6350
06.80.754	<a href="#">1</a>	06.80.415H	Extension overhaul kit	G3500 – CSA	105 mm	30 mm	259-2078

Above Overhaul Kits contain following Subcomponents

P/N	P/N Teflon® Insulator including Seal Ring	P/N included Silicone Seal Ring	P/N included Insulator Seal	P/N Lip Seal Ring <sup>1)</sup>	P/N Secondary Terminal
06.80.419H	06.80.279H	06.84.059		06.81.051 <a href="#">2</a>	02.85.881 <a href="#">3</a>
06.80.742	06.80.742-2	06.84.059	06.81.084	06.81.051 <a href="#">2</a>	06.51.134 <a href="#">3</a>
06.80.420H	06.80.280H	06.84.059		06.81.051 <a href="#">2</a>	06.51.136 <a href="#">3</a>
06.80.744	06.80.744-2	06.84.059	06.81.084	06.81.051 <a href="#">2</a>	06.51.133 <a href="#">3</a>
06.80.515H	06.80.335H-1	06.84.040		06.81.051 <a href="#">2</a>	02.85.881 <a href="#">3</a>
06.80.752	06.80.752-2	06.84.040	06.81.084	06.81.051 <a href="#">2</a>	02.85.870 <a href="#">3</a>
06.80.480	06.80.481	06.84.040		06.81.051 <a href="#">2</a>	02.85.881 <a href="#">3</a>
06.80.754	06.80.754-2	06.84.040	06.81.084	06.81.051 <a href="#">2</a>	02.85.870 <a href="#">3</a>

<sup>1)</sup> Lip seal ring P/N 06.81.051 equivalent to P/N 135-2651.

Teflon® Covered Extension Rods – Low Cost Style <sup>1)</sup>

P/N <sup>2)</sup>	Description	Primary Connection	Secondary Connection	Equivalent to
06.80.349-L	Teflon® covered extension rod	SAE	snap-on attachment	TCRC-L
06.80.376-L	Teflon® covered extension rod	SAE	#8-32 screw-on attachment	TCR-L
06.80.376-10	Teflon® covered extension rod	SAE	#8-32 screw-on attachment	TCR-10WM, 207927A

<sup>1)</sup> We recommend using PolyMot™ spark plug leads.

<sup>2)</sup> Standard lengths (-L) = 3 in, 4 in, 5 in, 6 in, 8 in, 10 in, 12 in, 14 in, 16 in, 18 in, 20 in, 24 in; other lengths available on request.



# Spark Plug Leads & Extensions



SHIELDED

## Extensions for Shielded Spark Plugs to Shielded Spark Plug Leads



P/N <sup>1)</sup>	Figure	Description	Spark Plug Connection	Termination Well Depth	Ignition Coil Connection	Termination Well Depth	Equivalent to
95.07.020-L	1	Shielded spark plug extension	5/8-24 UNEF	1 in	5/8-24 UNEF	1 in	
95.07.021-L	1	Shielded spark plug extension	3/4-20 UNEF	1 in	3/4-20 UNEF	1 in	M"L"-2S
95.07.022-L	1	Shielded spark plug extension	3/4-20 UNEF	2 in	3/4-20 UNEF	2 in	M"L"-2E
95.07.023-L	1	Shielded spark plug extension	5/8-24 UNEF	1 in	3/4-20 UNEF	2 in	
95.07.024-L	1	Shielded spark plug extension	3/4-20 UNEF	1 in	3/4-20 UNEF	2 in	

<sup>1)</sup> Standard lengths (-L) = 4 in, 5 in, 6 in, 8 in, 10 in, 12 in, 18 in; other lengths available on request.

## Extensions for Integral Ignition Coils to Shielded Spark Plugs



P/N <sup>1)</sup>	Figure	Description	Spark Plug Connection	Termination Well Depth	Ignition Coil Connection	Termination Well Depth	Equivalent to
95.07.010-L	2	Integral ignition coil extension	5/8-24 UNEF	1 in	1-20 UNEF	2 in	BG E Series
95.07.011-L	2	Integral ignition coil extension	3/4-20 UNEF	1 in	1-20 UNEF	2 in	593120-L, M"L"-2C
95.07.012-L	2	Integral ignition coil extension	3/4-20 UNEF	2 in	1-20 UNEF	2 in	593130-L, M"L"-1C
95.07.013-L	2	Integral ignition coil extension	13/16-20 UNEF	2 in	1-20 UNEF	2 in	593140-L

<sup>1)</sup> Standard lengths (-L) = 1.5 in, 3 in, 6 in, 9 in, 11 in, 19 in; other lengths available on request.



1



2

# Ignition Wiring Rails & Hardware

SHIELDED



## Wiring Rail System for Ignition Control

MOTORTECH stainless steel, vibration resistant rail assembly will withstand any harsh environment commonly found in the oil & gas industry. The proven design is made for engine manufacturers and the global aftermarket.

Do not go Low-Tech and take the risk of engine down time because of equipment being under repair. Eliminate the need for constant rewiring, connector exchanges or straightening out weak and bent aluminum wiring rails.

- Made of stainless steel
- Rigid military style connectors
- Rails are filled with special foam to ensure that all wires are separated from ground and will not vibrate
- Water-proof design – built to last in uncovered environment
- Repairable by MOTORTECH's assigned distributors in the event of mechanically damage
- Wiring rails can be used for shielded and unshielded applications
- Due to base rail structure easy for stocking
- Quick service access with quick-disconnect connections

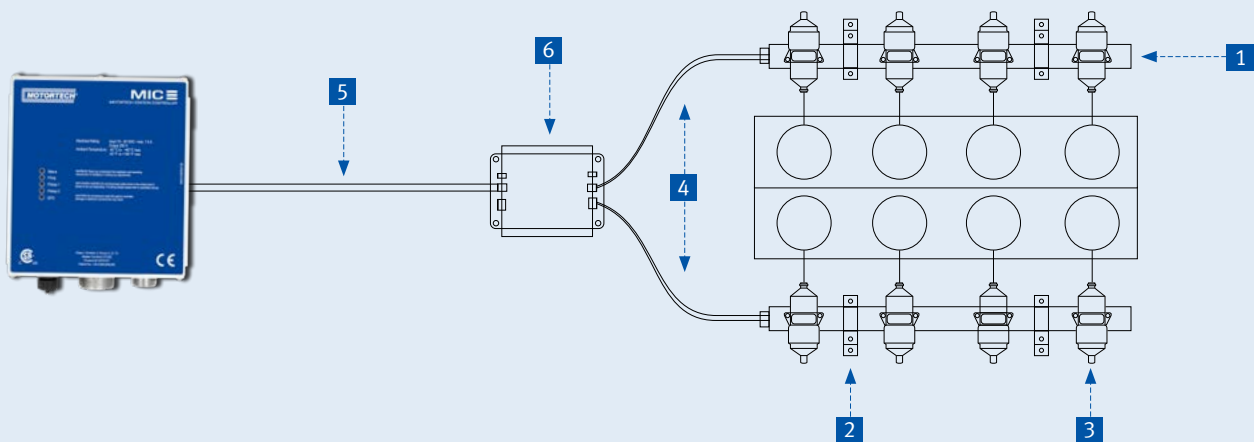
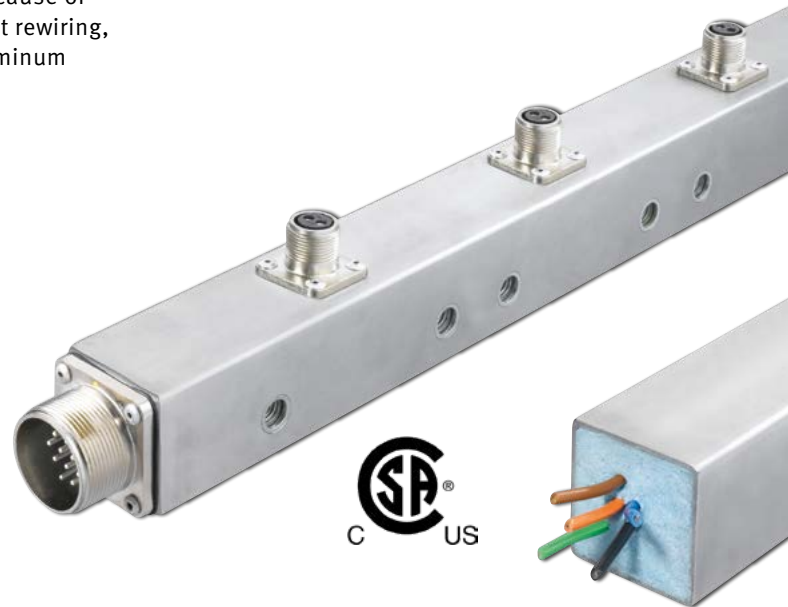
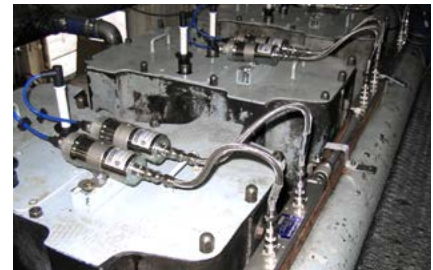

# Ignition Wiring Rails & Hardware



## 1 AlphaRail for Ignition Control – Specification Table

P/N 95.8 **A** **B** **C** **D** **E** **F** **G** **H** **J**

A	Ignition Coils per Cylinder		
6	Engine with one ignition coil per cylinder		
7	Engine with two ignition coils per cylinder <sup>1)</sup>		

<sup>1)</sup> See “HJ” for distance between two ignition coils.

B	Number of Cylinders per Bank		
1	Special version	5	5 cylinders
2	2 cylinders	6	6 cylinders
3	3 cylinders	8	8 cylinders
4	4 cylinders	0	10 cylinders

CD	Distance between the Cylinders		
04	4 in	12	12 in
06	6 in	13	13 in
07	7 in	14	14 in
08	8 in	16	16 in
10	10 in	27	27 in
11	11 in	33	33 in

E	Ignition Coil Mounting		
N	STANDARD – NO ignition coil mounted		

F	Double Rail <sup>1)</sup> – Length of Flex Conduit		
A	NO Double Rail	E	24 in
B	12 in	F	32 in
C	16 in	G	40 in
D	20 in	H	52 in

<sup>1)</sup> Two ignition wiring rails connected by flex conduit.

G	Specification of Ignition Coil		
N	STANDARD – NO ignition coil mounted <sup>1)</sup>		

<sup>1)</sup> Ignition coils have to be ordered separately  
(See page 32 – Ignition Coils)

HJ	Distance between two Ignition Coils – Only for two Ignition Coils per Cylinder		
04	4 in	16	16 in
06	6 in	18	18 in
08	8 in	20	20 in
10	10 in	22	22 in
12	12 in	24	24 in
14	14 in		

# Ignition Wiring Rails & Hardware

## 1 AlphaRail for Ignition Control – Wiring Rails for common Applications <sup>1)</sup>

P/N	Description	Engine Make	Model	Required Quantity per Engine
95.87.420-NBN-05	AlphaRail wiring rail	CATERPILLAR®	G399	2
95.86.406-NAN	AlphaRail wiring rail	CATERPILLAR®	G3304	1
95.86.606-NAN	AlphaRail wiring rail	CATERPILLAR®	G3306	1
95.86.607-NAN	AlphaRail wiring rail	CATERPILLAR®	G3406	1
95.86.407-NAN	AlphaRail wiring rail	CATERPILLAR®	G3408	2
95.86.607-NAN	AlphaRail wiring rail	CATERPILLAR®	G3412	2
95.86.411-NAN	AlphaRail wiring rail	CATERPILLAR®	G3508	2
95.86.611-NAN	AlphaRail wiring rail	CATERPILLAR®	G3512	2
95.86.811-NAN	AlphaRail wiring rail	CATERPILLAR®	G3516	2
95.87.631-NGN-08	AlphaRail wiring rail	CLARK®	HBA-6T	1
95.87.531-NAN-08	AlphaRail wiring rail	CLARK®	HBA-10T	2
95.87.637-NAN	AlphaRail wiring rail	CLARK®	TCVD-12	2
95.87.631-NGN-10	AlphaRail wiring rail	CLARK®	TLA-6T	1
95.87.544-NGN-06	AlphaRail wiring rail	COOPER®	GMVH-10	2
95.87.541-NGN-10	AlphaRail wiring rail	COOPER®	GMW-10	2
95.87.340-NAN	AlphaRail wiring rail	COOPER®	GMWC-6	2
95.87.822-NGN-06	AlphaRail wiring rail	COOPER®	LSV-16	2
95.87.633-NFN-22	AlphaRail wiring rail	INGERSOLL RAND®	KVR-412	2
95.87.344-NAN-04	AlphaRail wiring rail	INGERSOLL RAND®	KVS-6	2
95.86.427-NDN	AlphaRail wiring rail	INGERSOLL RAND®	PKVG-8	2
95.86.627-NDN	AlphaRail wiring rail	INGERSOLL RAND®	PKVG-12	2
95.86.627-NFN	AlphaRail wiring rail	INGERSOLL RAND®	PKVGR-12	2
95.86.437-NAN	AlphaRail wiring rail	INGERSOLL RAND®	XVG-8	2
95.86.606-NAN	AlphaRail wiring rail	WAUKESHA®	F817	1
95.86.614-NAN	AlphaRail wiring rail	WAUKESHA®	F1197GL/GU	1
95.86.608-NAN	AlphaRail wiring rail	WAUKESHA®	VG F18	1
95.86.808-NAN	AlphaRail wiring rail	WAUKESHA®	VG F H24	1
95.86.609-NAN	AlphaRail wiring rail	WAUKESHA®	VG F L36	2
95.86.809-NAN	AlphaRail wiring rail	WAUKESHA®	VG F P48	2
95.86.614-NAN	AlphaRail wiring rail	WAUKESHA®	VHP F2895GL/GSI	1
95.86.614-NAN	AlphaRail wiring rail	WAUKESHA®	VHP F3521GSI	1
95.86.614-NAN	AlphaRail wiring rail	WAUKESHA®	VHP L5790GSI	2
95.86.614-NAN	AlphaRail wiring rail	WAUKESHA®	VHP L7042G/GL/GU/GSI	2
95.86.614-NAN	AlphaRail wiring rail	WAUKESHA®	VHP L7044GL/GSI	2
95.86.814-NFN	AlphaRail wiring rail	WAUKESHA®	VHP P9390GL/GSI	2
95.86.815-NAN	AlphaRail wiring rail	WAUKESHA®	8L-AT27GL	1
95.86.618-NAN	AlphaRail wiring rail	WAUKESHA®	12V-AT27GL	2
95.86.818-NAN	AlphaRail wiring rail	WAUKESHA®	16V-AT27GL	2
95.86.814-NAN	AlphaRail wiring rail	WHITE SUPERIOR®	2408G	1
95.86.613-NAN	AlphaRail wiring rail	WHITE SUPERIOR®	6G/GT/GTL825	1
95.86.813-NAN	AlphaRail wiring rail	WHITE SUPERIOR®	8G/GTL825	1
95.86.616-NAN	AlphaRail wiring rail	WHITE SUPERIOR®	12GTLA825	2
95.86.616-NAN	AlphaRail wiring rail	WHITE SUPERIOR®	12SGT	2
95.86.816-NAN	AlphaRail wiring rail	WHITE SUPERIOR®	16GT/GTLB825	2
95.86.816-NAN	AlphaRail wiring rail	WHITE SUPERIOR®	16SGT	2
95.87.531-NAN-08	AlphaRail wiring rail	WORTHINGTON®	UTC-10	2

<sup>1)</sup> **NOTE:** Applications may vary due to different variants or attachments, which could affect the installation of mentioned wiring rails. Consult factory for details and final confirmation.

# Ignition Wiring Rails & Hardware

## 2 Bracket Configuration

P/N <sup>1)</sup>	Figure	Description
75.10.303	2A	Bracket, 40x40 mm (Standard)
75.10.097	2B	Flat bar, 180° (Standard)
75.10.120	2C	Flat bar, 150°
75.10.280	2D	Flat bar, 90°

<sup>1)</sup> For packs of ten please add suffix “-10” to part number (e.g. 75.10.303-10).

## 3 Primary Lead Kits for Ignition Coils – Unshielded <sup>1)</sup>

P/N	Figure	Description	For use with Ignition Coil P/N
06.99.200-1	3A	Primary lead kit incl. fastening material for ignition coil	06.50.003, 06.50.053, 06.50.054, 06.50.055, 06.50.060, 06.50.065
06.99.200-2	3B	Primary lead kit incl. fastening material for ignition coil	06.50.100, 06.50.102, 06.50.104, 06.50.105, 06.50.112, 06.50.113, 06.50.300, 06.50.301
06.99.200-3	3C	Primary lead kit incl. fastening material for ignition coil	06.50.103

<sup>1)</sup> Primary lead kits have to be ordered separately in required quantity.

## 3 Primary Lead Kits for Ignition Coils – Shielded <sup>1)</sup>

P/N	Figure	Description	For use with Ignition Coil P/N
95.99.200-1	3D	Primary lead kit incl. fastening material for ignition coil	95.08.003, 95.08.070
95.99.200-2	3E	Primary lead kit incl. fastening material for ignition coil	95.09.005, 95.09.054, 95.09.055, 95.09.070, 95.09.074, 95.09.075
95.99.200-2-X	3E	Primary lead kit incl. fastening material for ignition coil	95.09.053, 95.09.073

<sup>1)</sup> Primary lead kits have to be ordered separately in required quantity. See page 70 for primary leads for use with flange or integral ignition coils.

## 4 Harnesses to connect Wiring Rail and Junction Box <sup>1)</sup>

P/N	Figure	Description	Connector	Length
95.40.114-L	4A	Harness, with fitting for 1/2 in flex conduit	MIL, 14 pole, socket, 180°	L= 5/15/25/50 ft
95.40.314-L	4B	Harness, with fitting for 1/2 in flex conduit	MIL, 14 pole, socket, 90°	L= 5/15/25/50 ft

<sup>1)</sup> For CSA applications flex conduit has to be ordered separately or supplied by customer.





# Ignition Wiring Rails & Hardware

## 5 Harnesses to connect Ignition Controller and Junction Box – Specification Table

P/N 95.4 **A** . **B** **C** **D** - **E**

A	Harness
0	Standard harness, with fitting for 1/2 in or 3/4 in flex conduit

B	Connector Arrangement
1	socket 180°
2	pin 180°
3	socket 90°
4	pin 90°

CD	Number of Sockets/Pins in Connector
05	5 pole, with fitting for 1/2 in flex conduit
07	7 pole, with fitting for 1/2 in flex conduit
10	10 pole, with fitting for 1/2 in flex conduit
14	14 pole, with fitting for 1/2 in flex conduit
17	17 pole, with fitting for 3/4 in flex conduit
19	19 pole, with fitting for 3/4 in flex conduit
35	35 pole, with fitting for 3/4 in flex conduit

E	Length of Harness
5	5 ft
15	15 ft
25	25 ft
50	50 ft

Specification Table:

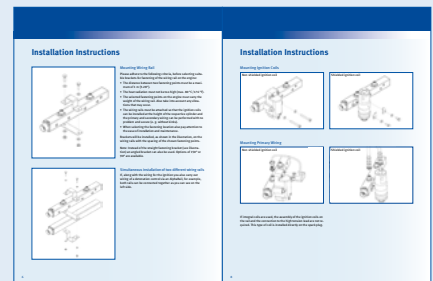
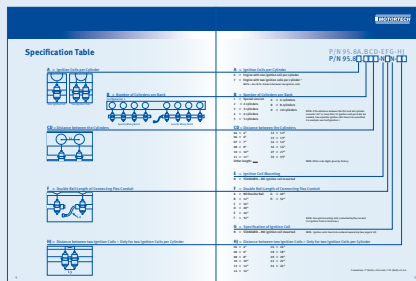
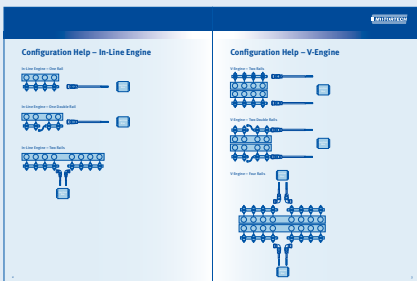

## 6 Accessories

P/N	Figure	Description	Equivalent to
06.05.075	6A	Junction box	593600-1
15.07.112	6B	Flex conduit, 1/2 in, black <sup>1)</sup>	
15.07.221	6C	Fitting, 1/2 in, junction box to flex conduit	
15.07.134	6B	Flex conduit, 3/4 in, black <sup>1)</sup>	
15.07.231	6C	Fitting, 3/4 in, junction box to flex conduit	

<sup>1)</sup> Flex conduit needs to be ordered in m/ft in required length.



6A



6B



6C

# Ignition Wiring Rails & Hardware

SHIELDED



## Ignition Wiring Rail Upgrade Kits

Wiring Rail Kits for **CATERPILLAR® G3300 and G3400 Series Gas Engines**  
**Shielded Applications with Magneto or Ignition Control Unit <sup>1)</sup>**



P/N	Description	Equivalent to
95.75.025-1-B	<b>Ignition wiring rail kit without ignition control unit for CATERPILLAR® G3304</b> ■ Incl. harness to ALTRONIC® magneto ■ Mounting bracket welded to the rail ■ “G” lead connector ■ <b>New Flex Style</b> shielded primary leads to fit 3 pole integral ignition coils <sup>2)</sup> ■ Timing light adaptor	251-2052
95.75.025-1	<b>Ignition wiring rail kit without ignition control unit for CATERPILLAR® G3304</b> ■ Incl. harness to ALTRONIC® magneto ■ Mounting bracket welded to the rail ■ “G” lead connector ■ <b>Conventional Style</b> shielded primary leads to fit 3 pole integral ignition coils <sup>2)</sup> ■ Timing light adaptor	251-2052
95.75.024-1-B	<b>Ignition wiring rail kit without ignition control unit for CATERPILLAR® G3306</b> ■ Incl. harness to ALTRONIC® magneto ■ Mounting bracket welded to the rail ■ “G” lead connector ■ <b>New Flex Style</b> shielded primary leads to fit 3 pole integral ignition coils <sup>2)</sup> ■ Timing light adaptor	251-2053
95.75.024-1	<b>Ignition wiring rail kit without ignition control unit for CATERPILLAR® G3306</b> ■ Incl. harness to ALTRONIC® magneto ■ Mounting bracket welded to the rail ■ “G” lead connector ■ <b>Conventional Style</b> shielded primary leads to fit 3 pole integral ignition coils <sup>2)</sup> ■ Timing light adaptor	251-2053
95.75.067-1-B	<b>Ignition wiring rail kit without ignition control unit for CATERPILLAR® G3406</b> ■ Incl. harness to CATERPILLAR® ignition control unit ■ Mounting bracket welded to the rail ■ “G” lead connector ■ <b>New Flex Style</b> shielded primary leads to fit 3 pole integral ignition coils <sup>2)</sup> ■ Timing light adaptor	291-5862 (wiring rail) 290-7079 (harness)
95.75.067-1	<b>Ignition wiring rail kit without ignition control unit for CATERPILLAR® G3406</b> ■ Incl. harness to CATERPILLAR® ignition control unit ■ Mounting bracket welded to the rail ■ “G” lead connector ■ <b>Conventional Style</b> shielded primary leads to fit 3 pole integral ignition coils <sup>2)</sup> ■ Timing light adaptor	291-5862 (wiring rail) 290-7079 (harness)

<sup>1)</sup> Magneto or ignition control unit are not included in the scope of supply.

<sup>2)</sup> Integral ignition coils need to be ordered separately. See page 50 – Integral Ignition Coils – Slim Design.

### Options available on included Primary Leads

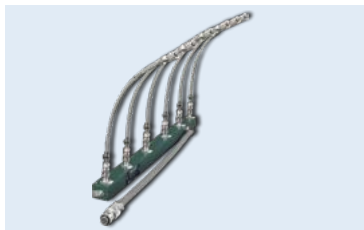

Ignition Wiring Rail

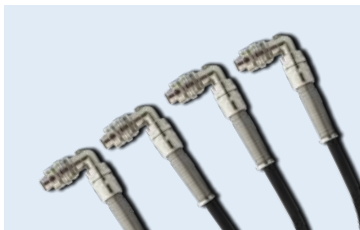

**New Flex Style** Primary Leads







**Conventional Style** Primary Leads

# Ignition Wiring Rails & Hardware



## Ignition Upgrade Kits for CATERPILLAR® G3300 and G3400 Series Gas Engines to replace Magneto Ignition Systems Unshielded/Shielded Applications

P/N	Supersedes	Description
75.00.536	75.00.338	<b>Ignition upgrade kit for CATERPILLAR® G3304 – unshielded applications</b> <ul style="list-style-type: none"> <li>Incl. MIC3+ ignition controller</li> <li>Input and output harnesses</li> <li>AlphaRail wiring rail with high energy ignition coils and brackets</li> <li>Spark plug leads</li> <li>Mechanical trigger conversion kit with disc (4+1), adaptor ring, gaskets and inductive pickup</li> <li>Magneto drive cover kit</li> </ul>
95.75.536 		<b>Ignition upgrade kit for CATERPILLAR® G3304 – shielded applications</b> <ul style="list-style-type: none"> <li>Incl. MIC3+ ignition controller</li> <li>Input and output harnesses <sup>1)</sup></li> <li>AlphaRail wiring rail and brackets</li> <li>New Flex Style shielded primary leads to fit 3 pole integral ignition coils <sup>2)</sup></li> <li>Mechanical trigger kit with disc (4+1), adaptor ring, gaskets and inductive pickup</li> <li>Magneto drive cover kit</li> </ul>
75.00.537	75.00.337	<b>Ignition upgrade kit for CATERPILLAR® G3306 – unshielded applications</b> <ul style="list-style-type: none"> <li>Incl. MIC3+ ignition controller</li> <li>Input and output harnesses</li> <li>AlphaRail wiring rail with high energy ignition coils and brackets</li> <li>Spark plug leads</li> <li>Mechanical trigger conversion kit with disc (6+1), adaptor ring, gaskets and inductive pickup</li> <li>Magneto drive cover kit</li> </ul>
95.75.537 		<b>Ignition upgrade kit for CATERPILLAR® G3306 – shielded applications</b> <ul style="list-style-type: none"> <li>Incl. MIC3+ ignition controller</li> <li>Input and output harnesses <sup>1)</sup></li> <li>AlphaRail wiring rail and brackets</li> <li>New Flex Style shielded primary leads to fit 3 pole integral ignition coils <sup>2)</sup></li> <li>Mechanical trigger kit with disc (6+1), adaptor ring, gaskets and inductive pickup</li> <li>Magneto drive cover kit</li> </ul>
75.00.538	75.00.336	<b>Ignition upgrade kit for CATERPILLAR® G3406 – unshielded applications</b> <ul style="list-style-type: none"> <li>Incl. MIC3+ ignition controller</li> <li>Input and output harnesses</li> <li>AlphaRail wiring rail with high energy ignition coils and brackets</li> <li>PolyMot™ spark plug leads</li> <li>Mechanical trigger kit with disc (6+1), adaptor ring, gaskets and inductive pickup</li> <li>Magneto drive cover kit</li> </ul>
95.75.538 		<b>Ignition upgrade kit for CATERPILLAR® G3406 – shielded applications</b> <ul style="list-style-type: none"> <li>Incl. MIC3+ ignition controller</li> <li>Input and output harnesses <sup>1)</sup></li> <li>AlphaRail wiring rail and brackets</li> <li>New Flex Style shielded primary leads to fit 3 pole integral ignition coils <sup>2)</sup></li> <li>Mechanical trigger kit with disc (6+1), adaptor ring, gaskets and inductive pickup</li> <li>Magneto drive cover kit</li> </ul>
75.00.539		<b>Ignition upgrade kit for CATERPILLAR® G3408 – unshielded applications</b> <ul style="list-style-type: none"> <li>Incl. MIC3+ ignition controller</li> <li>Input and output harnesses</li> <li>High energy ignition coils</li> <li>PolyMot™ spark plug leads</li> <li>TriDev trigger device and inductive pickup</li> </ul>
95.75.539 		<b>Ignition upgrade kit for CATERPILLAR® G3408 – shielded applications</b> <ul style="list-style-type: none"> <li>Incl. MIC3+ ignition controller</li> <li>Input and output harnesses <sup>1)</sup></li> <li>AlphaRail wiring rail and brackets</li> <li>New Flex Style shielded primary leads to fit 3 pole integral ignition coils <sup>2)</sup></li> <li>TriDev trigger device and inductive pickup</li> </ul>
75.00.540		<b>Ignition upgrade kit for CATERPILLAR® G3412 – unshielded applications</b> <ul style="list-style-type: none"> <li>Incl. MIC3+ ignition controller</li> <li>Input and output harnesses</li> <li>High energy ignition coils</li> <li>PolyMot™ spark plug leads</li> <li>TriDev trigger device and inductive pickup</li> </ul>
95.75.540 		<b>Ignition upgrade kit for CATERPILLAR® G3412 – shielded applications</b> <ul style="list-style-type: none"> <li>Incl. MIC3+ ignition controller</li> <li>Input and output harnesses <sup>1)</sup></li> <li>AlphaRail wiring rail and brackets</li> <li>New Flex Style shielded primary leads to fit 3 pole integral ignition coils <sup>2)</sup></li> <li>TriDev trigger device and inductive pickup</li> </ul>

<sup>1)</sup> For shielded input harness, additional flex conduit P/N 15.07.112 needs to be ordered separately.

<sup>2)</sup> Integral ignition coils need to be ordered separately. See page 50 – Integral Ignition Coils – Slim Design.

# Ignition Wiring Rails & Hardware

SHIELDED



## Wiring Rail Kits for CATERPILLAR® G3600 Series Gas Engines

P/N	Description	Equivalent to
95.75.108-B	<b>Wiring rail kit, ignition/detonation control for CATERPILLAR® G3606</b> ■ AlphaRail wiring rail assembly ■ Connecting harness, main junction box to wiring rail ■ <b>New Flex Style</b> shielded primary leads for AlphaRail	213-6308
95.75.108	<b>Wiring rail kit, ignition/detonation control for CATERPILLAR® G3606</b> ■ AlphaRail wiring rail assembly ■ Connecting harness, main junction box to wiring rail ■ <b>Conventional Style</b> shielded primary leads for AlphaRail	213-6308
95.75.103-B	<b>Wiring rail kit, ignition/detonation control for CATERPILLAR® G3608</b> ■ AlphaRail wiring rail assembly ■ Connecting harness, main junction box to wiring rail ■ <b>New Flex Style</b> shielded primary leads for AlphaRail	219-9946
95.75.103	<b>Wiring rail kit, ignition/detonation control for CATERPILLAR® G3608</b> ■ AlphaRail wiring rail assembly ■ Connecting harness, main junction box to wiring rail ■ <b>Conventional Style</b> shielded primary leads for AlphaRail	219-9946
95.75.106-B	<b>Wiring rail kit, ignition/detonation control for CATERPILLAR® G3612</b> ■ AlphaRail wiring rail assembly, right and left bank ■ Connecting harnesses, main junction box to wiring rails ■ <b>New Flex Style</b> shielded primary leads for AlphaRail	191-5007 (right) 191-5008 (left)
95.75.106	<b>Wiring rail kit, ignition/detonation control for CATERPILLAR® G3612</b> ■ AlphaRail wiring rail assembly, right and left bank ■ Connecting harnesses, main junction box to wiring rails ■ <b>Conventional Style</b> shielded primary leads for AlphaRail	191-5007 (right) 191-5008 (left)
95.75.107-B	<b>Wiring rail kit, ignition/detonation control for CATERPILLAR® G3616</b> ■ AlphaRail wiring rail assembly, right and left bank ■ Connecting harnesses, main junction box to wiring rails ■ <b>New Flex Style</b> shielded primary leads for AlphaRail	198-2938 (right) 198-2941 (left)
95.75.107	<b>Wiring rail kit, ignition/detonation control for CATERPILLAR® G3616</b> ■ AlphaRail wiring rail assembly, right and left bank ■ Connecting harnesses, main junction box to wiring rails ■ <b>Conventional Style</b> shielded primary leads for AlphaRail	198-2938 (right) 198-2941 (left)

### Options available on included Primary Leads



AlphaRail Wiring Rail Assembly



Connecting Harness



New Flex Style Primary Leads



Conventional Style Primary Leads

# Ignition Wiring Rails & Hardware



## Wiring Rail Kits for WAUKESHA® VGF Series Gas Engines – Shielded Applications with CEC Ignition Controller



P/N	Description	Equivalent to
95.75.339	<b>Ignition wiring rail upgrade kit for WAUKESHA® VGF F18</b> For use with existing WAUKESHA® CEC ignition controller <ul style="list-style-type: none"> <li>AlphaRail wiring rail and mounting brackets</li> <li>Connecting harness, ignition controller to wiring rail</li> <li><b>New Flex Style</b> shielded primary leads for AlphaRail</li> </ul>	
95.75.340	<b>Ignition wiring rail upgrade kit for WAUKESHA® VGF H24</b> For use with existing WAUKESHA® CEC ignition controller <ul style="list-style-type: none"> <li>AlphaRail wiring rail and mounting brackets</li> <li>Connecting harness, ignition controller to wiring rail</li> <li><b>New Flex Style</b> shielded primary leads for AlphaRail</li> </ul>	



## Wiring Rail Kits for 12 Cylinder WAUKESHA® VHP ESM Series Gas Engines



P/N	Description	Equivalent to
95.75.048-B	<b>Ignition wiring rail kit for 12 Cylinder WAUKESHA® VHP ESM Series Gas Engines</b> <ul style="list-style-type: none"> <li>AlphaRail wiring rails and mounting brackets</li> <li>Connecting harness assembly, ESM to wiring rails</li> <li><b>New Flex Style</b> shielded primary leads for AlphaRail</li> </ul>	740283
95.75.048	<b>Ignition wiring rail kit for 12 Cylinder WAUKESHA® VHP ESM Series Gas Engines</b> <ul style="list-style-type: none"> <li>AlphaRail wiring rails and mounting brackets</li> <li>Connecting harness assembly, ESM to wiring rails</li> <li><b>Conventional Style</b> shielded primary leads for AlphaRail</li> </ul>	740283

### Options available on included Primary Leads



AlphaRail Wiring Rail



Connecting Harness

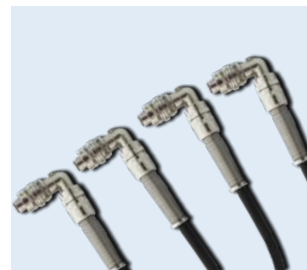

New Flex Style Primary Leads





Conventional Style Primary Leads



# Ignition Wiring Rails & Hardware



## Upgrade Kits for WAUKESHA® VHP G/GU/GSI 12 Cylinder Gas Engines – Ignition and Detonation Control

P/N	Description
95.75.120-12 	<b>Shielded ignition control upgrade kit for WAUKESHA® VHP G/GU/GSI 12 cylinder engines</b> <ul style="list-style-type: none"> <li>■ MIC4 series ignition controller</li> <li>■ 1 pickup arrangement (Hall effect) incl. shielded pickup leads, trigger disc and hub</li> <li>■ Output wiring and junction box with fittings to connect ignition controller and wiring rails</li> <li>■ AlphaRail wiring rails with hardware kit</li> <li>■ High energy integral ignition coils</li> <li>■ <b>New Flex Style</b> primary leads for connection of wiring rails and integral ignition coils</li> </ul>
77.75.120-12	<b>Unshielded ignition control upgrade kit for WAUKESHA® VHP G/GU/GSI 12 cylinder engines</b> <ul style="list-style-type: none"> <li>■ MIC4 series ignition controller</li> <li>■ 1 pickup arrangement (Hall effect) incl. shielded pickup leads, trigger disc and hub</li> <li>■ Output wiring and junction box with fittings to connect ignition controller and wiring rails</li> <li>■ AlphaRail wiring rails with hardware kit</li> <li>■ High energy ignition coils</li> <li>■ Primary lead and mounting kits for connection of wiring rails and ignition coils</li> <li>■ PolyMot™ spark plug leads</li> </ul>
95.75.121-12 	<b>Shielded ignition control upgrade kit for WAUKESHA® VHP G/GU/GSI 12 cylinder engines</b> <b>For use with existing WAUKESHA® CEC ignition controller</b> <ul style="list-style-type: none"> <li>■ Output wiring and junction box with fittings to connect CEC ignition controller and wiring rails</li> <li>■ AlphaRail wiring rails with hardware kit</li> <li>■ Integral ignition coils to work with CEC Spark Reference System</li> <li>■ <b>New Flex Style</b> primary leads for connection of wiring rails and integral ignition coils</li> </ul>
77.75.121-12	<b>Unshielded ignition control upgrade kit for WAUKESHA® VHP G/GU/GSI 12 cylinder engines</b> <b>For use with existing WAUKESHA® CEC ignition controller</b> <ul style="list-style-type: none"> <li>■ Output wiring and junction box with fittings to connect CEC ignition controller and wiring rails</li> <li>■ AlphaRail wiring rails with hardware kit</li> <li>■ Ignition coils to work with CEC Spark Reference System</li> <li>■ Primary lead and mounting kits for connection of wiring rails and ignition coils</li> <li>■ PolyMot™ spark plug leads</li> </ul>
43.00.421-12 <sup>1)</sup>	<b>Detonation control upgrade kit for WAUKESHA® VHP G/GU/GSI/GL 12 cylinder engines</b> <ul style="list-style-type: none"> <li>■ DetCon20 detonation controller with 20 inputs</li> <li>■ Harnesses to connect detonation controller and wiring rails</li> <li>■ AlphaRail wiring rails with hardware kit</li> <li>■ Leads for connection of wiring rails and detonation sensors</li> <li>■ Detonation sensors to monitor each cylinder individually <sup>2)</sup></li> </ul>

<sup>1)</sup> For use in hazardous and non-hazardous environments.

<sup>2)</sup> Prepared cylinder head cap screws for each detonation sensor available on request. See page 156 – DetCon Detonation Control System

## Ignition Kits for Unshielded Applications

### Ignition Kits for MAN® E0834 Series Gas Engines

P/N	Engine Model	Ignition Controller	Wiring Rail Type	Ignition Coil P/N	PolyMot™ Spark Plug Lead		Pickup P/N (Qty)	Mounting Kit for Wiring Rail P/N <sup>2)</sup>
					P/N	Fits Spark Plug <sup>1)</sup>		
75.00.651	E0834 E302/312/LE302	MIC3+ series	LiteRail	06.50.300	06.85.839H-16	GK3-5	66.60.003-60 (1)	75.41.006
75.00.581 <sup>3)</sup>	E0834 E302/312/LE302	MIC3+ series	LiteRail	06.50.300	06.85.1037-16	B4321	66.60.003-60 (1)	75.41.006
75.00.501	E0834 E302/312/LE302	MIC4 series	LiteRail	06.50.104	06.85.839H-16	GK3-5	66.60.003-60 (1)	75.41.006
75.00.601 <sup>3)</sup>	E0834 E302/312/LE302	MIC4 series	LiteRail	06.50.104	06.85.1037-16	B4321	66.60.003-60 (1)	75.41.006

### Ignition Kits for MAN® E0836 Series Gas Engines

P/N	Engine Model	Ignition Controller	Wiring Rail Type	Ignition Coil P/N	PolyMot™ Spark Plug Lead		Pickup P/N (Qty)	Mounting Kit for Wiring Rail P/N <sup>2)</sup>
					P/N	Fits Spark Plug <sup>1)</sup>		
75.00.652	E0836 E302/312	MIC3+ series	LiteRail	06.50.300	06.85.839H-16	GK3-5	66.60.003-60 (1)	75.41.011
75.00.582 <sup>3)</sup>	E0836 E302/312	MIC3+ series	LiteRail	06.50.300	06.85.1037-16	B4321	66.60.003-60 (1)	75.41.011
75.00.502	E0836 E302/312	MIC4 series	LiteRail	06.50.104	06.85.839H-16	GK3-5	66.60.003-60 (1)	75.41.011
75.00.602 <sup>3)</sup>	E0836 E302/312	MIC4 series	LiteRail	06.50.104	06.85.1037-16	B4321	66.60.003-60 (1)	75.41.011
75.00.653	E0836 LE202	MIC3+ series	LiteRail	06.50.300	06.85.836H-16	GE3-5	66.60.003-60 (1)	75.41.011
75.00.583 <sup>3)</sup>	E0836 LE202	MIC3+ series	LiteRail	06.50.300	06.85.1031-16	B4321	66.60.003-60 (1)	75.41.011
75.00.503	E0836 LE202	MIC4 series	LiteRail	06.50.104	06.85.836H-16	GE3-5	66.60.003-60 (1)	75.41.011
75.00.603 <sup>3)</sup>	E0836 LE202	MIC4 series	LiteRail	06.50.104	06.85.1031-16	B4321	66.60.003-60 (1)	75.41.011
75.00.653	E0836 LE302	MIC3+ series	LiteRail	06.50.300	06.85.836H-16	GE3-5	66.60.003-60 (1)	75.41.036
75.00.583 <sup>3)</sup>	E0836 LE302	MIC3+ series	LiteRail	06.50.300	06.85.1031-16	B4321	66.60.003-60 (1)	75.41.036
75.00.503	E0836 LE302	MIC4 series	LiteRail	06.50.104	06.85.836H-16	GE3-5	66.60.003-60 (1)	75.41.036
75.00.603 <sup>3)</sup>	E0836 LE302	MIC4 series	LiteRail	06.50.104	06.85.1031-16	B4321	66.60.003-60 (1)	75.41.036

### Ignition Kits for MAN® E2676 Series Gas Engines

P/N	Engine Model	Ignition Controller	Wiring Rail Type	Ignition Coil P/N	PolyMot™ Spark Plug Lead		Pickup P/N (Qty)	Mounting Kit for Wiring Rail P/N <sup>2)</sup>
					P/N	Fits Spark Plug <sup>1)</sup>		
75.00.655	E2676 E302/LE202/212	MIC3+ series	LiteRail	06.50.300	06.85.929-20	GK3-5	66.60.003-60 (1)	75.41.003
75.00.585 <sup>3)</sup>	E2676 E302/LE202/212	MIC3+ series	LiteRail	06.50.300	06.85.1038-20	B4321	66.60.003-60 (1)	75.41.003
75.00.505	E2676 E302/LE202/212	MIC4 series	LiteRail	06.50.104	06.85.929-20	GK3-5	66.60.003-60 (1)	75.41.003
75.00.605 <sup>3)</sup>	E2676 E302/LE202/212	MIC4 series	LiteRail	06.50.104	06.85.1038-20	B4321	66.60.003-60 (1)	75.41.003

### Ignition Kits for MAN® E2876 Series Gas Engines

P/N	Engine Model	Ignition Controller	Wiring Rail Type	Ignition Coil P/N	PolyMot™ Spark Plug Lead		Pickup P/N (Qty)	Mounting Kit for Wiring Rail P/N <sup>2)</sup>
					P/N	Fits Spark Plug <sup>1)</sup>		
75.00.654	E2876 E302/312/TE302	MIC3+ series	LiteRail	06.50.300	06.85.836H-16	GE3-5	66.60.003-60 (1)	75.41.005
75.00.584 <sup>3)</sup>	E2876 E302/312/TE302	MIC3+ series	LiteRail	06.50.300	06.85.1031-16	B4321	66.60.003-60 (1)	75.41.005
75.00.504	E2876 E302/312/TE302	MIC4 series	LiteRail	06.50.104	06.85.836H-16	GE3-5	66.60.003-60 (1)	75.41.005
75.00.604 <sup>3)</sup>	E2876 E302/312/TE302	MIC4 series	LiteRail	06.50.104	06.85.1031-16	B4321	66.60.003-60 (1)	75.41.005
75.00.656	E2876 LE202/212/302	MIC3+ series	LiteRail	06.50.300	06.85.836H-18	GE3-5	66.60.003-60 (1)	75.41.025
75.00.586 <sup>3)</sup>	E2876 LE202/212/302	MIC3+ series	LiteRail	06.50.300	06.85.1031-18	B4321	66.60.003-60 (1)	75.41.025
75.00.506	E2876 LE202/212/302	MIC4 series	LiteRail	06.50.104	06.85.836H-18	GE3-5	66.60.003-60 (1)	75.41.025
75.00.606 <sup>3)</sup>	E2876 LE202/212/302	MIC4 series	LiteRail	06.50.104	06.85.1031-18	B4321	66.60.003-60 (1)	75.41.025

<sup>1)</sup> Mentioned spark plugs for comparison purposes only and not included in scope of supply.

<sup>2)</sup> Mounting kits for wiring rails are not included in scope of supply and need to be ordered separately.

<sup>3)</sup> Ignition kit includes magnetic spark plug socket to fit MHP spark plug B4321 with long insulator.

## Ignition Wiring Rails & Hardware



### Ignition Kits for MAN® E2848 Series Gas Engines

P/N	Engine Model	Ignition Controller	Wiring Rail Type	Ignition Coil P/N	PolyMot™ Spark Plug Lead		Pickup P/N (Qty)	Mounting Kit for Wiring Rail P/N <sup>2)</sup>
					P/N	Fits Spark Plug <sup>1)</sup>		
75.00.657	E2848 LE322	MIC3+ series	LiteRail	06.50.300	06.85.836H-16	GE3-5	66.60.003-100 (1)	75.41.034
75.00.587 <sup>3)</sup>	E2848 LE322	MIC3+ series	LiteRail	06.50.300	06.85.1031-16	B4321	66.60.003-100 (1)	75.41.034
75.00.507	E2848 LE322	MIC4 series	LiteRail	06.50.104	06.85.836H-16	GE3-5	66.60.003-100 (1)	75.41.034
75.00.607 <sup>3)</sup>	E2848 LE322	MIC4 series	LiteRail	06.50.104	06.85.1031-16	B4321	66.60.003-100 (1)	75.41.034

### Ignition Kits for MAN® E2842 Series Gas Engines

P/N	Engine Model	Ignition Controller	Wiring Rail Type	Ignition Coil P/N	PolyMot™ Spark Plug Lead		Pickup P/N (Qty)	Mounting Kit for Wiring Rail P/N <sup>2)</sup>
					P/N	Fits Spark Plug <sup>1)</sup>		
75.00.658	E2842 E/LE312	MIC3+ series	LiteRail	06.50.300	06.85.836H-16	GE3-5	66.60.003-100 (1), 66.60.001-250 (1)	75.41.013
75.00.588 <sup>3)</sup>	E2842 E/LE312	MIC3+ series	LiteRail	06.50.300	06.85.1031-16	B4321	66.60.003-100 (1), 66.60.001-250 (1)	75.41.013
75.00.508	E2842 E/LE312	MIC4 series	LiteRail	06.50.104	06.85.836H-16	GE3-5	66.60.003-100 (1), 66.60.001-250 (1)	75.41.013
75.00.608 <sup>3)</sup>	E2842 E/LE312	MIC4 series	LiteRail	06.50.104	06.85.1031-16	B4321	66.60.003-100 (1), 66.60.001-250 (1)	75.41.013
75.00.659	E2842 LE202/322/332	MIC3+ series	LiteRail	06.50.300	06.85.836H-16	GE3-5	66.60.003-100 (1)	75.41.037
75.00.589 <sup>3)</sup>	E2842 LE202/322/332	MIC3+ series	LiteRail	06.50.300	06.85.1031-16	B4321	66.60.003-100 (1)	75.41.037
75.00.509	E2842 LE202/322/332	MIC4 series	LiteRail	06.50.104	06.85.836H-16	GE3-5	66.60.003-100 (1)	75.41.037
75.00.609 <sup>3)</sup>	E2842 LE202/322/332	MIC4 series	LiteRail	06.50.104	06.85.1031-16	B4321	66.60.003-100 (1)	75.41.037

### Ignition Kits for MAN® E3268 Series Gas Engines – To fit Valve Covers **without** Flange Safety Device

P/N	Engine Model	Ignition Controller	Wiring Rail Type	Ignition Coil P/N	PolyMot™ Spark Plug Lead		Pickup P/N (Qty)	Mounting Kit for Wiring Rail P/N <sup>2)</sup>
					P/N	Fits Spark Plug <sup>1)</sup>		
75.00.661	E3268 LE212/222	MIC3+ series	LiteRail	06.50.300	06.85.959-18	GE3-5	66.60.003-100 (1)	75.41.023, alternative 75.41.033
75.00.591 <sup>3)</sup>	E3268 LE212/222	MIC3+ series	LiteRail	06.50.300	06.85.1023-18	B4321	66.60.003-100 (1)	75.41.023, alternative 75.41.033
75.00.595	E3268 LE212/222	MIC3+ series	LiteRail	06.50.300	06.85.1042-18	GL3-5, B8324	66.60.003-100 (1)	75.41.023, alternative 75.41.033
75.00.511	E3268 LE212/222	MIC4 series	LiteRail	06.50.104	06.85.959-18	GE3-5	66.60.003-100 (1)	75.41.023, alternative 75.41.033
75.00.611 <sup>3)</sup>	E3268 LE212/222	MIC4 series	LiteRail	06.50.104	06.85.1023-18	B4321	66.60.003-100 (1)	75.41.023, alternative 75.41.033
75.00.596	E3268 LE212/222	MIC4 series	LiteRail	06.50.112	06.85.1042-18	GL3-5, B8324	66.60.003-100 (1)	75.41.023, alternative 75.41.033

<sup>1)</sup> Mentioned spark plugs for comparison purposes only and not included in scope of supply.

<sup>2)</sup> Mounting kits for wiring rails are not included in scope of supply and need to be ordered separately.

<sup>3)</sup> Ignition kit includes magnetic spark plug socket to fit MHP spark plug B4321 with long insulator.

# Ignition Wiring Rails & Hardware



## Ignition Kits for MAN® E3268 Series Gas Engines – To fit Valve Covers **with** Flange Safety Device

P/N	Engine Model	Ignition Controller	Wiring Rail Type	Ignition Coil P/N	PolyMot™ Spark Plug Lead		Pickup P/N (Qty)	Mounting Kit for Wiring Rail P/N <sup>2)</sup>
					P/N	Fits Spark Plug <sup>1)</sup>		
75.00.668-141	E3268 LE212/222	MIC3+ series	LiteRail	06.50.300	06.85.1078-18 <sup>4)</sup>	GE3-5, 14R-4DIU2, 7315	66.60.003-100 (1)	75.41.023, alternative 75.41.033
75.00.668-142 <sup>3)</sup>	E3268 LE212/222	MIC3+ series	LiteRail	06.50.300	06.85.1079-18 <sup>4)</sup>	B4321	66.60.003-100 (1)	75.41.023, alternative 75.41.033
75.00.668-143	E3268 LE212/222	MIC3+ series	LiteRail	06.50.300	06.85.1073-18 <sup>4)</sup>	GE2-3, FN8xWWCC, 14GZ-LL, 14GZ-LL2	66.60.003-100 (1)	75.41.023, alternative 75.41.033
75.00.668-181	E3268 LE212/222	MIC3+ series	LiteRail	06.50.300	06.85.1074-18 <sup>4)</sup>	GL3-5, 7308	66.60.003-100 (1)	75.41.023, alternative 75.41.033
75.00.668-182	E3268 LE212/222	MIC3+ series	LiteRail	06.50.300	06.85.1080-18 <sup>4)</sup>	B8324, 18GZ5-77-2	66.60.003-100 (1)	75.41.023, alternative 75.41.033
75.00.511-144	E3268 LE212/222	MIC4 series	LiteRail	06.50.112	06.85.1102-18 <sup>4)</sup>	14R-4DIU3	66.60.003-100 (1)	75.41.023, alternative 75.41.033
75.00.511-181	E3268 LE212/222	MIC4 series	LiteRail	06.50.112	06.85.1074-18 <sup>4)</sup>	GL3-5, 7308	66.60.003-100 (1)	75.41.023, alternative 75.41.033
75.00.511-182	E3268 LE212/222	MIC4 series	LiteRail	06.50.112	06.85.1080-18 <sup>4)</sup>	B8324, 18GZ5-77-2	66.60.003-100 (1)	75.41.023, alternative 75.41.033

## Ignition Kits for MAN® E3262 Series Gas Engines – To fit Valve Covers **without** Flange Safety Device

P/N	Engine Model	Ignition Controller	Wiring Rail Type	Ignition Coil P/N	PolyMot™ Spark Plug Lead		Pickup P/N (Qty)	Mounting Kit for Wiring Rail P/N <sup>2)</sup>
					P/N	Fits Spark Plug <sup>1)</sup>		
75.00.627	E3262 E302	MIC3+ series	LiteRail	06.50.300	06.85.959-18	GE3-5	66.60.003-100 (1), 66.60.001-250 (1)	75.41.023
75.00.631 <sup>3)</sup>	E3262 E302	MIC3+ series	LiteRail	06.50.300	06.85.1023-18	B4321	66.60.003-100 (1), 66.60.001-250 (1)	75.41.023
75.00.647	E3262 E302	MIC3+ series	LiteRail	06.50.300	06.85.1042-18	GL3-5, B8324	66.60.003-100 (1), 66.60.001-250 (1)	75.41.023
75.00.660	E3262 LE202/212	MIC3+ series	LiteRail	06.50.300	06.85.959-18	GE3-5	66.60.003-100 (1)	75.41.023, alternative 75.41.033
75.00.590 <sup>3)</sup>	E3262 LE202/212	MIC3+ series	LiteRail	06.50.300	06.85.1023-18	B4321	66.60.003-100 (1)	75.41.023, alternative 75.41.033
75.00.597	E3262 LE202/212	MIC3+ series	LiteRail	06.50.300	06.85.1042-18	GL3-5, B8324	66.60.003-100 (1)	75.41.023, alternative 75.41.033

<sup>1)</sup> Mentioned spark plugs for comparison purposes only and not included in scope of supply.

<sup>2)</sup> Mounting kits for wiring rails are not included in scope of supply and need to be ordered separately.

<sup>3)</sup> Ignition kit includes magnetic spark plug socket to fit MHP spark plug B4321 with long insulator.

<sup>4)</sup> Included PolyMot™ spark plug leads fit new valve covers with flange safety device of MAN E32 series.

Please also see page 232 for MOTORTECH valve cover conversion kit for recommended retrofitting of already operating engines without safety devices.

**NEW**

## Valve Cover Conversion Kit with Flange Safety Device for Spark Plug Leads For MAN® E32 Series Gas Engines

Please also see page 232 for MOTORTECH valve cover conversion kit for recommended retrofitting of already operating engines without safety devices.

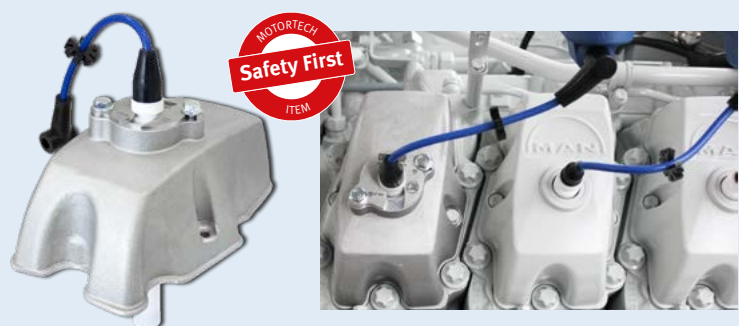

# Ignition Wiring Rails & Hardware

## Ignition Kits for MAN® E3262 Series Gas Engines – To fit Valve Covers **without** Flange Safety Device

P/N	Engine Model	Ignition Controller	Wiring Rail Type	Ignition Coil P/N	PolyMot™ Spark Plug Lead		Pickup P/N (Qty)	Mounting Kit for Wiring Rail P/N <sup>2)</sup>
					P/N	Fits Spark Plug <sup>1)</sup>		
75.00.510	E3262 LE202/212	MIC4 series	LiteRail	06.50.104	06.85.959-18	GE3-5	66.60.003-100 (1)	75.41.023, alternative 75.41.033
75.00.610 <sup>3)</sup>	E3262 LE202/212	MIC4 series	LiteRail	06.50.104	06.85.1023-18	B4321	66.60.003-100 (1)	75.41.023, alternative 75.41.033
75.00.598	E3262 LE202/212	MIC4 series	LiteRail	06.50.112	06.85.1042-18	GL3-5, B8324	66.60.003-100 (1)	75.41.023, alternative 75.41.033

## Ignition Kits for MAN® E3262 Series Gas Engines – To fit Valve Covers **with** Flange Safety Device

P/N	Engine Model	Ignition Controller	Wiring Rail Type	Ignition Coil P/N	PolyMot™ Spark Plug Lead		Pickup P/N (Qty)	Mounting Kit for Wiring Rail P/N <sup>2)</sup>
					P/N	Fits Spark Plug <sup>1)</sup>		
75.00.669-141	E3262 E302	MIC3+ series	LiteRail	06.50.300	06.85.1078-18 <sup>4)</sup>	GE3-5, 14R-4DIU2, 7315	66.60.003-100 (1), 66.60.001-250 (1)	75.41.023
75.00.669-142 <sup>3)</sup>	E3262 E302	MIC3+ series	LiteRail	06.50.300	06.85.1079-18 <sup>4)</sup>	B4321	66.60.003-100 (1), 66.60.001-250 (1)	75.41.023
75.00.669-143	E3262 E302	MIC3+ series	LiteRail	06.50.300	06.85.1073-18 <sup>4)</sup>	GE2-3, FN8xWWCC, 14GZ-LL, 14GZ-LL2	66.60.003-100 (1), 66.60.001-250 (1)	75.41.023
75.00.669-181	E3262 E302	MIC3+ series	LiteRail	06.50.300	06.85.1074-18 <sup>4)</sup>	GL3-5, 7308	66.60.003-100 (1), 66.60.001-250 (1)	75.41.023
75.00.669-182	E3262 E302	MIC3+ series	LiteRail	06.50.300	06.85.1080-18 <sup>4)</sup>	B8324, 18GZ5-77-2	66.60.003-100 (1), 66.60.001-250 (1)	75.41.023
75.00.675-144	E3262 E302	MIC4 series	LiteRail	06.50.112	06.85.1102-18 <sup>4)</sup>	14R-4DIU3	66.60.003-100 (1), 66.60.001-250 (1)	75.41.023
75.00.675-181	E3262 E302	MIC4 series	LiteRail	06.50.112	06.85.1074-18 <sup>4)</sup>	GL3-5, 7308	66.60.003-100 (1), 66.60.001-250 (1)	75.41.023
75.00.675-182	E3262 E302	MIC4 series	LiteRail	06.50.112	06.85.1080-18 <sup>4)</sup>	B8324, 18GZ5-77-2	66.60.003-100 (1), 66.60.001-250 (1)	75.41.023
75.00.670-141	E3262 LE202/212	MIC3+ series	LiteRail	06.50.300	06.85.1078-18 <sup>4)</sup>	GE3-5, 14R-4DIU2, 7315	66.60.003-100 (1)	75.41.023, alternative 75.41.033
75.00.670-142 <sup>3)</sup>	E3262 LE202/212	MIC3+ series	LiteRail	06.50.300	06.85.1079-18 <sup>4)</sup>	B4321	66.60.003-100 (1)	75.41.023, alternative 75.41.033
75.00.670-143	E3262 LE202/212	MIC3+ series	LiteRail	06.50.300	06.85.1073-18 <sup>4)</sup>	GE2-3, FN8xWWCC, 14GZ-LL, 14GZ-LL2	66.60.003-100 (1)	75.41.023, alternative 75.41.033
75.00.670-181	E3262 LE202/212	MIC3+ series	LiteRail	06.50.300	06.85.1074-18 <sup>4)</sup>	GL3-5, 7308	66.60.003-100 (1)	75.41.023, alternative 75.41.033
75.00.670-182	E3262 LE202/212	MIC3+ series	LiteRail	06.50.300	06.85.1080-18 <sup>4)</sup>	B8324, 18GZ5-77-2	66.60.003-100 (1)	75.41.023, alternative 75.41.033
75.00.510-141	E3262 LE202/212	MIC4 series	LiteRail	06.50.112	06.85.1078-18 <sup>4)</sup>	GE3-5, 14R-4DIU2, 7315	66.60.003-100 (1)	75.41.023, alternative 75.41.033
75.00.510-181	E3262 LE202/212	MIC4 series	LiteRail	06.50.112	06.85.1074-18 <sup>4)</sup>	GL3-5, 7308	66.60.003-100 (1)	75.41.023, alternative 75.41.033
75.00.510-182	E3262 LE202/212	MIC4 series	LiteRail	06.50.112	06.85.1080-18 <sup>4)</sup>	B8324, 18GZ5-77-2	66.60.003-100 (1)	75.41.023, alternative 75.41.033

<sup>1)</sup> Mentioned spark plugs for comparison purposes only and not included in scope of supply.

<sup>2)</sup> Mounting kits for wiring rails are not included in scope of supply and need to be ordered separately.

<sup>3)</sup> Ignition kit includes magnetic spark plug socket to fit MHP spark plug B4321 with long insulator.

<sup>4)</sup> Included PolyMot™ spark plug leads fit new valve covers with flange safety device of MAN E32 series.

Please also see page 232 for MOTORTECH valve cover conversion kit for recommended retrofitting of already operating engines without safety devices.





# Ignition Wiring Rails & Hardware



## Mounting Kits for Ignition Kits for MAN® Gas Engines

P/N	Supersedes	Description	Engine Model	Rail Mounting on
75.41.006		Mounting kit for ignition rail	E0834 E302/312/LE302	Engine
75.41.011		Mounting kit for ignition rail	E0836 E302/312/LE202	Engine
75.41.036		Mounting kit for ignition rail	E0836 LE302	Engine
75.41.003		Mounting kit for ignition rail	E2676 E302/LE202/212	Engine
75.41.005		Mounting kit for ignition rail	E2876 E302/312/TE302	Engine
75.41.025		Mounting kit for ignition rail	E2876 LE202/212/302	Engine
75.41.034	75.41.002, 75.41.026	Mounting kit for ignition rails	E2848 LE322	Intercooler
75.41.013		Mounting kit for ignition rails	E2842 E/LE312	Engine
75.41.037	75.41.001, 75.41.027	Mounting kit for ignition rails	E2842 LE202/322/332	Intercooler
75.41.023		Mounting kit for ignition rails	E3268 LE212/222, E3262 E302/LE202/212	Engine
75.41.033		Mounting kit for ignition rails	E3268 LE212/222, E3262 LE202/212	Intercooler

## Ignition Kits for LIEBHERR® G924 & G926 Series Gas Engines

P/N	Engine Model	Ignition Controller	Wiring Rail Type	Ignition Coil P/N	PolyMot™ Spark Plug Lead		Pickup P/N (Qty)	Mounting Kit for Wiring Rail P/N
					P/N	Fits Spark Plug <sup>1)</sup>		
75.00.512	G924	MIC3+ series	engine specific	06.50.300	06.85.857-18	GE3-5	66.60.003-100 (1)	integrated in wiring rail
75.00.624	G924	MIC3+ series	engine specific	06.50.300	06.85.1031-18	B4321	66.60.003-100 (1)	integrated in wiring rail
75.00.513	G926	MIC3+ series	engine specific	06.50.300	06.85.857-18	GE3-5	66.60.003-100 (1)	integrated in wiring rail
75.00.663	G926	MIC3+ series	engine specific	06.50.300	06.85.1031-18	B4321	66.60.003-100 (1)	integrated in wiring rail

## Ignition Kits for LIEBHERR® G93x & G94x Series Gas Engines

P/N	Engine Model	Ignition Controller	Wiring Rail Type	Ignition Coil P/N	Spark Plug <sup>1)</sup>	Pickup <sup>2)</sup>	Mounting Kit for Wiring Rail
75.00.433	G934/G944	MIC4 series	AlphaRail	06.50.104	not included	not included	75.41.010
75.00.434	G936/G946	MIC4 series	AlphaRail	06.50.104	not included	not included	75.41.008

<sup>1)</sup> MOTORTECH XTL Plug P/N B432BEX9-A107 has to be ordered separately in required quantity.

<sup>2)</sup> Scope of supply only includes wiring for LIEBHERR® pickup.

## Ignition Kits for LIEBHERR® G95xx Series Gas Engines

P/N	Engine Model	Ignition Controller	Wiring Rail Type	Ignition Coil P/N	Spark Plug <sup>1)</sup>	Pickup <sup>2)</sup>	Mounting Kit for Wiring Rail
75.00.435	G9508	MIC4 series	AlphaRail	06.50.104	not included	not included	75.41.022
75.00.436	G9512	MIC4 series	AlphaRail	06.50.104	not included	not included	75.41.021

<sup>1)</sup> MOTORTECH XTL Plug P/N B432BEX9-A107 has to be ordered separately in required quantity.

<sup>2)</sup> Scope of supply only includes wiring for LIEBHERR® pickup.



Rail mounting on intercooler



Rail mounting on engine



Ignition kit for LIEBHERR® gas engines



# Ignition Tools & Test Equipment

## SparkView MOTORTECH HIGH VOLTAGE INDICATOR

The SparkView is a handheld device developed by MOTORTECH that can monitor the high voltage required by the spark plug while the engine is running. With a measuring clamp or cable and the display for up to 40 kV, it is easy to determine the condition of the spark plugs and the time at which they need to be replaced. This guarantees a constant performance of the engine and a maximum utilization of the spark plugs.

Quick and comfortable monitoring on a running engine makes it possible to detect:

- Wear of spark plugs
- Failure of the ignition system (damaged ignition coil, spark plug lead or ignition controller)
- Faulty compression of a cylinder



### SparkView High Voltage Indicator

P/N	Figure	Description
06.90.099-100	1	SparkView high voltage indicator, incl. SparkScan1 high voltage clamp P/N 06.90.100, for use with spark plug leads
06.90.099-105	2	SparkView high voltage indicator, incl. BNC cable P/N 06.90.105, for use with flange ignition coils or externally mounted ignition coils with diagnostic interface



1



2

## SparkScan1 MOTORTECH HIGH VOLTAGE CLAMP

SparkScan1 is designed for operators who want to monitor their high voltage traces in a simple way. The inductive high voltage clamp is connected to a Scope Meter. When attached to a conventional ignition cable (7 mm), the clamp measures the high voltage pulse and via scope screen the operator can analyse the ignition trace.

Measuring high voltage peak (kV) and spark duration ( $\mu\text{sec}$ ) of all cylinders of an engine in a routine manner, will allow preventive maintenance of the equipment.



### SparkScan1 High Voltage Clamp

P/N	Description	Length
06.90.100	SparkScan1 high voltage clamp	2.0 m/7.0 ft

## Digital Scope Meter

The digital scope meter is a compact 20 MHz or 40 MHz two channel scope. Ideal for troubleshooting of industrial machinery, instrumentation, control and power systems. The scope meter has unique features like connect-and-view and trendplot that simplify taking measurements and reduce troubleshooting time when working in the field or in industrial environments.

### Digital Scope Meter

P/N	Description
06.98.005-110	Digital scope meter, 110 V
06.98.005-220	Digital scope meter, 220 V

### BNC Cable for use with SparkView or Digital Scope Meter

P/N	Description	Length
06.90.105	BNC cable	2.0 m/7.0 ft



SparkView High Voltage Indicator | SparkScan1 High Voltage Clamp

# Ignition Tools & Test Equipment



This test equipment is designed to offer service companies a professional tool to test all different kinds of ignition coils that were sold by engine manufacturers or aftermarket companies. A built in CD ignition, high voltage clamp and a spark gap allow realistic testing.

The ignition coil tester can be individually equipped with optionally available adaptor kits for testing different kinds of ignition coils.



## Ignition Coil Tester <sup>1)</sup>

P/N	Description
06.98.054	Ignition coil tester

<sup>1)</sup> Adapter kits required for ignition coil testing are not included in the scope of supply. Please observe the table below and order the required adapter kits separately.

## Adaptor Kits – Standard – including Teflon® Ignition Coil Adaptors and Connecting Leads

P/N	Description	Connections of included Lead	
		Ignition Coil	Ignition Coil Tester
06.98.054-1	Adaptor kit for CATERPILLAR® ignition coils, G3400 & G3500	DEUTSCH® connector	XLR connector
06.98.054-2	Adaptor kit for ALTRONIC® Style ignition coils	2 pole	XLR connector
06.98.054-3	Adaptor kit for MOTORTECH Style ignition coils	2 pole	XLR connector
06.98.054-4	Adaptor kit for flange ignition coils	MIL, 3 pole, socket, 180°	XLR connector
06.98.054-5	Adaptor kit for integral ignition coils, outer thread	MIL, 2/3 pole, socket, 180°	XLR connector
06.98.054-6	Adaptor kit for integral ignition coils, inner thread	MIL, 2/3 pole, socket, 180°	XLR connector
06.98.054-7	Adaptor kit for externally mounted ignition coils	MIL, 2/3 pole, socket, 180°	XLR connector

## Adaptor Kits – Special – including Connecting Leads

P/N	Description	Connections of included Lead	
		Ignition Coil	Ignition Coil Tester
06.70.192-5	Adaptor kit for CUMMINS® ignition coil P/N 3964547	4 pole, 180°	XLR connector
06.70.192-6	Adaptor kit for JENBACHER® ignition coil P/N 369083	4 pole, 180°	XLR connector



## IPS

MOTORTECH IGNITION PICKUP SIMULATOR

Anyone trying to troubleshoot electronic ignition systems has come to the conclusion that there are so many different things that can create problems.

The ignition pickup simulator allows the operator to simulate all pickup signals that are supposed to be generated by the different pickups installed on flywheel and camshaft. This way the ignition can actually be triggered with the appropriate amount of trigger events while the engine is not cranking. The IPS can be programmed for single and multiple pickup signal frequency.

A variety of adaptor harnesses is available to allow use of the IPS with different ignition controller brands and models.



### IPS Ignition Pickup Simulator

P/N	Description
07.98.047	IPS Ignition Pickup Simulator

### Adaptor Harnesses for IPS Ignition Pickup Simulator <sup>1)</sup>

P/N	IPS Adaptor Harness for use with
07.70.001	WOODWARD® IC9xx series
07.70.002-1	MIC500 series (P/N 06.00.508), WOODWARD® IC100 series with inductive pickup
07.70.002-2	MIC500 series (P/N 06.00.508), WOODWARD® IC100 series with Hall effect pickup
07.70.002-3	MIC500 series (P/N 06.00.508), WOODWARD® IC100 series with magnetic pickup
07.70.003	MIC500 series (P/N 06.00.510)
07.70.004	MIC3+CATDI (P/N 66.00.356-8, 66.00.357-12), MIC3+CEC (P/N 66.00.358-8, 66.00.359-12), MIC500 series (P/N 06.00.513, 06.00.514), ALTRONIC® DIS & DISN, CATERPILLAR® (P/N 163-6164, 163-6108)
07.70.005	FAIRBANKS MORSE® IQ250 series
07.70.006	ALTRONIC® CPU95 series
07.70.009	MOTORTECH MIC500 series (P/N 06.00.511)
07.70.010	MIC500 series (P/N 06.00.515-6, 06.00.515-8, 06.00.516, 06.00.517), WAUKESHA® CEC (VHP/VGF series)
07.70.011	MIC3/3+ series (P/N 66.00.310-6/-12, 66.00.350-6/-12), MIC4 series (P/N 66.00.424-8/-16), MIC5 series (P/N 66.00.541-20)
07.70.012	FAIRBANKS MORSE® IQ750 series
07.70.013	MIC500 series (P/N 06.00.520, 06.00.525, 06.00.530)
07.70.014	MIC850 series (P/N 66.00.850-24/-D, 66.00.851-24/-D, 66.00.855-12/-D/-24/-D)
07.70.015	MIC4 series (66.00.400-8/-16/410-8/-16/440-8/-16), MIC5 series (P/N 66.00.540-20/66.00.542-20)

<sup>1)</sup> Need to be ordered separately.

# Ignition Tools & Test Equipment

## Test Adaptor for MOTORTECH Ignition Controllers

To enable operators and service personnel to check input signals to the ignition controller in a simple way, MOTORTECH offers a Test Adaptor that links between the 35 pole input connector and the appropriate harness.

Terminals located around the test box allow easy access to each input signal entering the ignition controller. By use of a commonly used Digital Scope Meter, the following signals can be checked:

- Input voltage
- Analog input signal (4-20mA)
- Pickup signals
- Start/Stop signal
- Go/NoGo signal
- Timing schedule selection switch (A/B)



## Test Adaptor for MIC3/3+, MIC4, MIC5 and MIC6 Series Ignition Controllers

P/N	Supersedes	Description	For use with MOTORTECH Ignition Controllers
06.98.130		Test adaptor	MIC3/3+ series (P/N 66.00.310-6/-12, 66.00.350-6/-12) MIC4 series (P/N 66.00.424-8/-16) MIC5 series (P/N 66.00.541-20) MIC6 series (P/N 66.00.645-24)





## ScopeLite MOTORTECH TIMING LIGHT

The self-powered ScopeLite is designed to work with fully shielded ignition systems. A special clamp picks up the small trigger signal through the braid of conventional or MOT-Blues shielded spark plug leads. The signal is processed by the timing light and via LED technology a sequence of flashes is generated. On applications where MOTORTECH ignition coils with diagnostic interface are used, the ScopeLite can be attached directly to the BNC connector of the ignition coil.

Even on applications with integral or standard flange ignition coils, the clamp can be attached to the shielded primary lead. When timing is checked on engines with non-shielded spark plug leads, a selector switch needs to be pushed which then steps down sensitivity. The automatic time based shut-off function saves the 2 built in 9 V batteries in case the operator forgets to turn off power.

Makes it easy and safe for the operator!



### ScopeLite Timing Light

P/N	Description
06.98.100-200	ScopeLite timing light with LEDs, incl. clamp, 200 in standard connecting lead and carrying case

### Connecting Leads (Standard and Non Standard Lengths) <sup>1)</sup>

P/N	Description	Length
06.90.104-100	ScopeLite connecting lead	2.5 m/100 in
06.90.104-200	ScopeLite connecting lead	5.0 m/200 in
06.90.104-300	ScopeLite connecting lead	7.5 m/300 in
06.90.104-400	ScopeLite connecting lead	10.0 m/400 in
06.90.104-600	ScopeLite connecting lead	15.0 m/600 in

<sup>1)</sup> If non standard length is required, please order separately from above chart.



Use with MOT-Blues shielded spark plug leads.



Use with conventional shielded spark plug leads.



Use with MOTORTECH ignition coils with diagnostic interface or with shielded primary lead.



# Ignition Tools & Test Equipment

## Timing Light – Conventional Style

P/N	Description	Lead Length
06.98.043-10	Timing light	3.0 m/10.0 ft
06.98.043-30	Timing light	9.0 m/30.0 ft



## Repair Kit for Timing Light – Conventional Style

P/N	Description
06.98.044	Repair kit for timing light



## Digital Protractor

The Digital Protractor is a compact rotational angle measuring tool. The unit is equipped with magnets for easy and flexible installation on flywheel, camshaft, pulley or any other rotating gear.

P/N	Description
06.98.096	Digital protractor



## Spark Plug Lead Removal Tool for MAN® Gas Engines

P/N	Description
44.99.918	Spark plug lead removal tool for MAN® gas engines



## Installation Tool for Reluctor Pin

P/N	Description
44.99.011	Installation tool for reluctor pin P/N 06.80.104



## Workshop Equipment

P/N	Figure	Description
06.05.903-1	1	Spark plug test stand for M14, M18 and 7/8-18 UNS spark plugs
06.05.904-1	2	Engine simulator with 24 spark gap rack

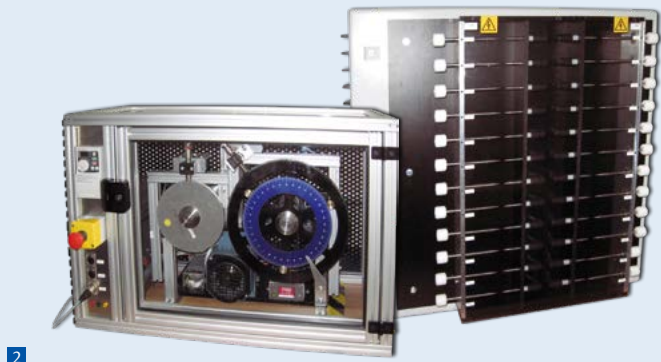

## Brush Kit to clean Termination Wells

Expensive ignition components, such as ignition coils, spark plug leads and extensions and extended barrel spark plugs can have an extended life if proper maintenance is available. The new brush kit is available to easily clean away the dirt, grime, and corrosion that can affect product life.

### Brush kit for use with

- Ignition coils
- Spark plug leads and extensions
- Extended barrel spark plugs

### Features

- Easy to use tool
- Cleans away dirt and corrosion safely
- Helps to increase component service life
- Bristles are of nylon impregnated with silicone to clean without scratching or removing any Teflon®
- Kit components separately available



Cleaning of spark plug extension



Cleaning of extended barrel spark plug



Cleaning of externally mounted ignition coil

## Brush Kit to clean Termination Wells

P/N	Supersedes	Description	Quantity	Equivalent to
07.98.075		Brush kit to clean termination wells <i>Contains:</i> <ul style="list-style-type: none"> <li>■ Nylon brushes, thread shanked</li> <li>■ Removable T-handle with screw</li> <li>■ Silicone grease, 5 oz (140 g) tube</li> <li>■ Grease applicator brush</li> </ul>	3 pcs 1 pc 1 pc 1 pc	

# Ignition Tools & Test Equipment

## Harness Connector Assembly Tools

P/N	Figure	Description
06.98.011	5	Crimping tool for studs
06.98.046	2	Installation tool for MIL style connector pins
06.98.051	7	Removal tool for MIL style connector pins

## Spark Plug Lead Assembly Tools

P/N	Figure	Description
06.98.011	5	Crimping tool for studs
06.98.013	6	Crimping tool for P/N 06.80.116
06.98.019	1	Assembly tool for P/N 06.98.109
06.98.047	3	Crimping tool for P/N 06.80.126 (already includes crimping tool insert P/N 06.98.048)
06.98.048	4	Crimping tool insert for P/N 06.98.047 to crimp terminal P/N 06.80.126
06.98.050	8	Crimping tool insert for P/N 06.98.047 to crimp terminal P/N 22.85.802 and P/N 22.85.803





## ■ Spark Plugs & Accessories



### The DDI's key to long plug life

DENSO has launched the latest generation of hard-wearing spark plugs – the DENSO DOUBLE IRIIDIUM (DDI) spark plug. DDI spark plug technology improves and extends the spark plug's lifespan and requires significantly less maintenance than competitor spark plugs. The DDI spark plug is particularly effective when used in biogas engines. Try DENSO DDI spark plugs today.

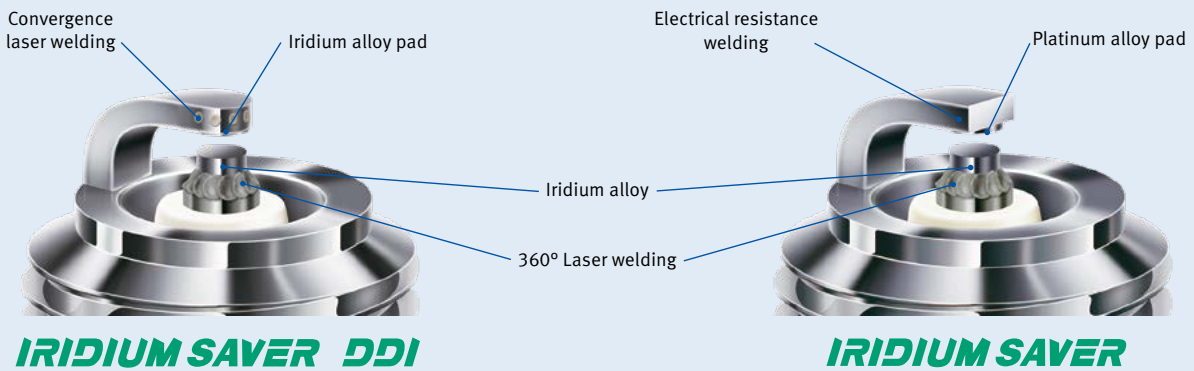

### The SAVER's key to long plug life

DENSO's OEM expertise and commitment to innovation enables them to remain at the forefront of cutting-edge gas engine spark plug development. The unique and specialist technology used in the Iridium Saver and Iridium Saver Performer spark plugs range extends their lifespan, making them ideal for high-compression lean-burn engines. Iridium Saver and Iridium Performer spark plugs also help to maximise engine performance and deliver extra durability. Because they require minimal maintenance compared to standard plugs, Iridium Saver and Iridium Saver Performer spark plugs increase service interval times.

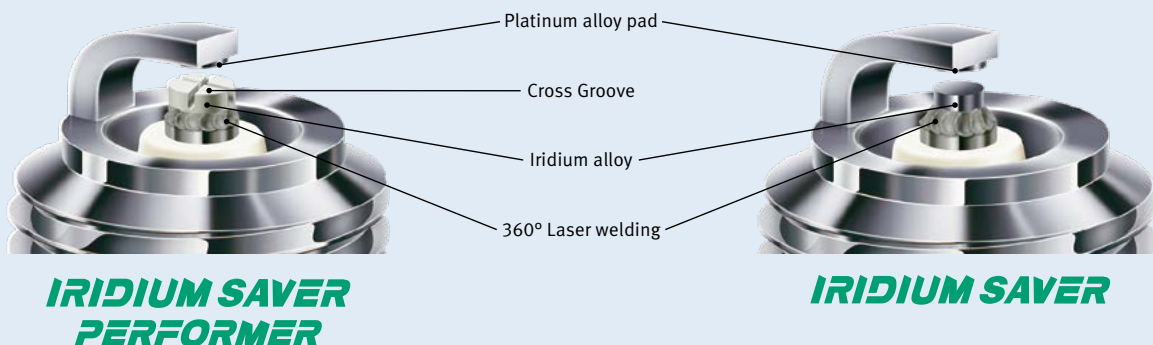

## Specifications and Cross References

for Gas Engines

**G I 3 - 1 (A)**

Installation Dimension and Tightening Torque				
No	Thread Size	HEX	Thread Reach	Tightening Torque
E	M14x1.25	13/16 in (20.8 mm)	0.750 in (19.0 mm)	with lubricant 20 Nm (15 lb-ft)
N			0.500 in (12.7 mm)	
K		5/8 in (16 mm)	0.750 in (19.0 mm)	without lubricant 30 Nm (22 lb-ft)
L	M18x1.5	13/16 in (20.8 mm)	0.811 in (20.6 mm)	with lubricant 30 Nm (22 lb-ft)
I		7/8 in (22.2 mm)	0.543 in (13.8 mm)	
T				

Initial Gap	
No	Nominal Value
2	0.2 mm
3	0.3 mm
5	0.5 mm

Terminal Design		
No	SPEC.	
	none	solid
A	with nut	

Electrode Design	
1. <b>IRIDIUM SAVER</b> Iridium pad without cross groove on center electrode and Platinum pad on ground electrode.	
3. <b>IRIDIUM SAVER</b> For vehicle.	
5. <b>IRIDIUM SAVER DDI</b> Iridium pad without cross groove on center electrode and Iridium pad on ground electrode.	
1. <b>IRIDIUM SAVER PERFORMER</b> Iridium pad with cross groove on center electrode and Platinum pad on ground electrode.	
3. <b>IRIDIUM SAVER</b> Iridium pad without cross groove on center electrode and Platinum pad on ground electrode.	
5. <b>IRIDIUM SAVER DDI</b> Iridium pad without cross groove on center electrode and Iridium pad on ground electrode.	

## Cross References

Thread	CHAMPION®	STITT®	ALTRONIC®	BERU®	BOSCH®	IRIDIUM SAVER	IRIDIUM SAVER DDI	IRIDIUM SAVER PERFORMER
M14	RN79G (0.015)	407XL, R407XL	J1463DP	14R-3CPU, 14-3CPU, 14R-5DPU, 14R-4CDP	7311	GE3-1	GE2-3 GE3-5	
	RN79G (0.020)			FN85WWCC, FN86WWCC, 14GZ-LL2, 14GZ-LL, 14R-4CIU (Z187), 14R-4CIU2 (Z215), 14R-4DIU2 (Z258), 14R-4DIU3	7315		GE2-3 GE3-5	
	RC78PYP, RC78PYP15			14R-4DPUO	7321	GK3-1	GK3-5	
	RC78WYP15			FC86WWCC, 14GZ-LL-FR, 14FR-4DIU	7322		GK3-5	
	RL85G, RL15B	407L, R407L	J1443DP	14R-5BPU, 14R-4ADP, 14R-5BIU		GN3-1		
M18	FB77WPCC, RB77WPCC, KB77WPCC, RB77CC, PB78WPC		L1863IP	18GZ4-77, 18GZ6-77-2	7305, 7306	G13-3	G13-5	G13-1
	RB75N, RB75PP	R807LL	L1863B, L1863DP	18GZ20	7302	G13-3	G13-5	G13-1
	RB75WPCC-1			18GZ5-77-2	7307, 7308	GL3-3	GL3-5	GL3-1
	RB76N, RB76PP	R807LL		18GZ7		G13-3	G13-5	G13-1
	RM77N	807, 827, 847, U827, U847	L1843B	18GZ22	7303			GT3-1
	RM77PP		L1843IP					



# Spark Plugs & Accessories



## DENSO® Spark Plug GE2-3

The new DENSO® spark plug GE2-3 was specially developed for use in state-of-the-art engine applications and, with its unique iridium alloy on the center and ground electrode, is ideally suited for operation with natural and special gases.

The new designed, protruding ground electrode with copper core provides improved heat dissipation and reduces wear on the electrode base material, resulting in increased electrical and mechanical strength and service life. The longer insulator design also offers the best protection against flashovers.

### General Features

- Longer insulator design offers best flashover protection
- The ground electrode with copper core increases the electrical and mechanical load capacity
- J-type electrode design for enhanced combustion
- Advanced spark erosion resistance

### Key Design Features

- 1 Longer ceramic insulator offers best flashover protection
- 2 Integrated stress resistant monolithic resistor suppresses electromagnetic interference (EMI)
- 3 J-type electrode design and use of higher erosion resistance materials
- 4 Center electrode with laser welded Iridium alloy pad
- 5 Protruding ground electrode with copper core and laser welded Iridium pad

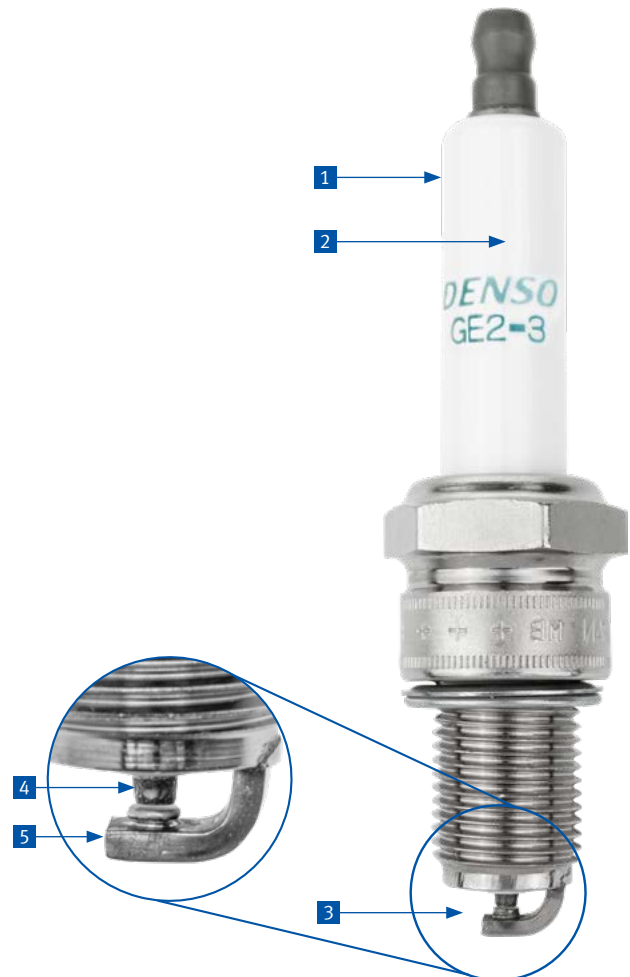

Installation Dimension and Tightening Torque				
Thread Size	HEX	Thread Reach	Tightening Torque	
M14x1.25	13/16 in (20.8 mm)	0.750 in (19.0 mm)	without lubricant	30 Nm, 22 lb-ft

## DENSO® Spark Plug GE2-3

P/N	Description	Equivalent to
GE2-3	DENSO® spark plug, M14x1,25, thread reach 19.0 mm (0.750 inch), Ir/Ir, electrode gap 0.20 mm (0.008 inch), HEX 20.8 mm (13/16 inch)	14GZ-LL2, 14GZ-LL, FN85WWCC, FN86WWCC, 14R-4DIU2, 14R-4DIU3, GE3-1, GE3-5, RN79G

# Spark Plugs & Accessories



## DENSO® Spark Plug GI3-4 – For ROLLS ROYCE®, WÄRTSILÄ® and CATERPILLAR® Gas Engines

The DENSO® spark plug GI3-4, for years an exclusively made product for engine manufacturers like ROLLS ROYCE® and WÄRTSILÄ®, is now available for the gas engine aftermarket.

Provided with all positive characteristics of the IRIDIUM SAVER PERFORMER family, the Cross Groove design, the 360° laser welding and iridium/platinum alloy on center and ground electrode, this spark plug type is one more DENSO® product standing for high quality and long life.

### The SAVER's key to long plug life

#### Unique "Iridium Alloy"

A unique, high welding point "iridium alloy" developed and patented by DENSO®, dramatically improves wear resistance compared to other iridium spark plugs.

#### 360° Laser Welding

Secure welding of the iridium tip by "360° laser welding" can withstand all extreme engine conditions.

#### Cross Groove Design

4 small electrodes created by Cross Groove improve sparking performance and suppress dispersion in voltage value, for an outstanding voltage decrease.



Installation Dimension and Tightening Torque				
Thread Size	HEX	Thread Reach	Tightening Torque	
M18x1.5	7/8 in (22.2 mm)	0.874 in (20.6 mm)	without lubricant	45 Nm, 33 lb-ft

### DENSO® Spark Plug GI3-4

P/N	Description	Equivalent to
GI3-4	DENSO® spark plug, M18x1.5, thread reach 20.6 mm (0.874 inch), Ir/Pt, electrode gap 0.28 mm (0.011 inch), HEX 22.2 mm (7/8 inch)	- Rolls Royce® 706522 - WÄRTSILÄ® PAAE009853, PAAE059695, PAAE250517, PAAF031654, PAAF060302 - CATERPILLAR® 193468054, 339-9790

## ■ Spark Plugs & Accessories



### Iridium Saver Spark Plug & Boot Kit For CUMMINS® ISL-G Engine Applications

MOTORTECH is pleased to offer the DENSO® GK3-7 Iridium Saver Spark Plug and rubber boot kit for CUMMINS® ISL-G gas engines. This protective rubber boot insulates the spark plug from the harsh environment. Combined with the reliable, long lasting Iridium Saver Spark Plug, this kit is the perfect combination for CUMMINS® natural gas engines.



#### Technical Benefits

- Unique iridium alloy
- 360° laser welding
- Highly reliable monolithic resistor
- Special nickel plating with better corrosive resistance
- High dielectric ceramics

#### Spark Plug & Boot Kit

P/N	Description	Quantity	Equivalent to
4955850-MOT	Spark plug and boot kit <i>Contains:</i> <ul style="list-style-type: none"> <li>■ Iridium 3-prong spark plug P/N GK3-7</li> <li>■ Spark plug boot P/N 06.84.053</li> <li>■ Dielectric grease</li> </ul>	1 pc 1 pc 1 pc	4955850 4937472 4989131, 3973945



## ■ Spark Plugs & Accessories

### **MHP-Plugs** MOTORTECH HIGH PERFORMANCE SPARK PLUGS

The expansion of MOTORTECH's state-of-the-art ignition controllers is driven by the latest developments of modern spark ignited gas engines. The operation of these high performance engines with advanced compression rates and very efficient lean-burn combustion systems require much higher voltages to allow a perfect and effective combustion.

MHP spark plugs are designed to meet the requirements, both of modern and common engine developments and reliably deliver highest voltages and thus a strong spark down into the combustion chamber. The J-type electrode design with IRIIDIUM alloy discs on center and ground electrode provides reliable combustion and increased spark plug life and helps to reduce service costs due less spark plug changes.



#### General Features

- Hot lock technology ensures increased spark plug durability even in high compression engines
- J-type electrode design for enhanced combustion
- Long design insulators for best flashover protection
- Advanced spark erosion resistance
- Suppression of electromagnetic interference (EMI)
- Less spark plug changes reduce operation costs
- Available with different thread sizes and reaches
  - M14x1.25
  - M18x1.5
  - M22x1.5
  - 7/8-18 UNS

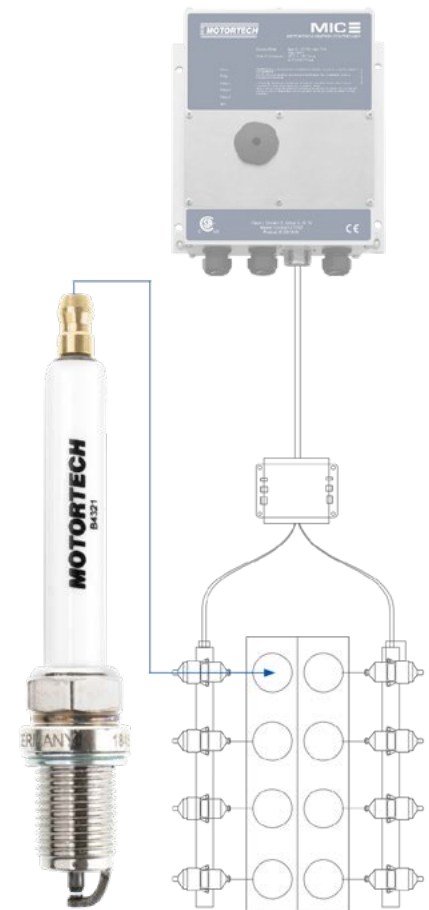

# Spark Plugs & Accessories



## Key Design Features

- 1 Removable threaded brass SAE terminal
- 2 Long aluminum oxide ceramic insulator offers best flashover protection, especially in combination with PolyMot™ spark plug leads and extensions
- 3 Integrated stress resistant monolithic resistor suppresses electromagnetic interference (EMI)
- 4 Unified hex size reduces amount of required service tools for installation
- 5 J-type electrode design and use of higher erosion resistance materials ensure better combustion particularly on lean burn gas engines and longest service life
- 6 Copper cored center electrode with laser welded IRIDIUM alloy disc
- 7 Copper cored ground electrode with laser welded IRIDIUM alloy disc

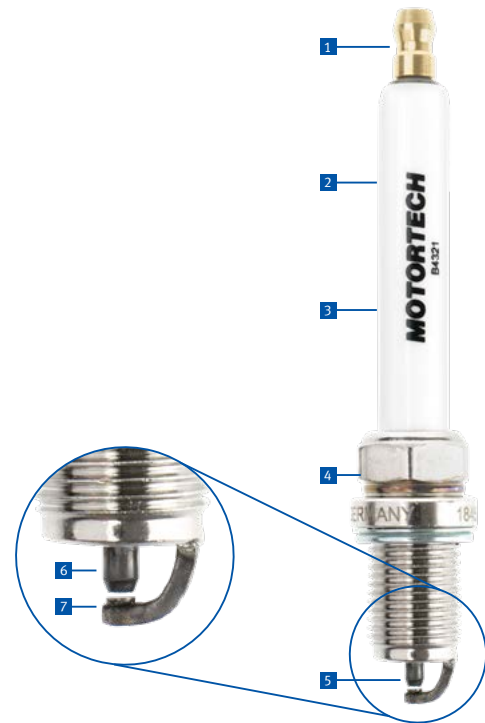

## MOTORTECH High Performance Spark Plugs

P/N <sup>1)</sup>	Description	Thread Size	Thread Reach	Electrode Design (Alloy)	HEX	Equivalent to <sup>2)</sup>
B4321	MHP spark plug	M14x1.25	0.750 in (19.0 mm)	J-type (Ir/Ir)	5/8 in (16.0 mm)	J1463DP, 14FR-4DIU3, FC86WWCC, FN85WWCC, FN86WWCC, 14GZ-LL, 14GZ-LL2, 14GZ-LL-FR, 14GZ6-77-2, RN79G, RC78PYP, GE2-3, GE3-5, GK3-5
B8124	MHP spark plug	M18x1.5	0.500 in (12.7 mm)	J-type (Ir/Ir)	13/16 in (20.8 mm)	L1843IP, 18GZ22, RB485-1, RM77N, RM77PP, GT3-1, 7303
B8324	MHP spark plug	M18x1.5	0.750 in (19.0 mm)	J-type (Ir/Ir)	13/16 in (20.8 mm)	L1863IP, 18GZ5-77-2, 18GZ6-77-2, RB75WPCC, FB77WPCC, GL3-5, G13-5, 7305, 7306, 7307, 7308
<b>NEW</b> B8324-LTN <sup>3)</sup>	MHP spark plug	M18x1.5	0.750 in (19.0 mm)	J-type (Ir/Ir)	13/16 in (20.8 mm)	301-6663, 243-4291, 194-8518, 76.64.375, 76.64.292, 76.64.291, 69919D, 69919C, 69919A, 69919
B8524	MHP spark plug	M18x1.5	1.000 in (25.4 mm)	J-type (Ir/Ir)	13/16 in (20.8 mm)	
B2224	MHP spark plug	M22x1.5	0.600 in (15.0 mm)	J-type (Ir/Ir)	13/16 in (20.8 mm)	
B2324	MHP spark plug	M22x1.5	0.750 in (19.0 mm)	J-type (Ir/Ir)	13/16 in (20.8 mm)	
B2424	MHP spark plug	M22x1.5	0.875 in (22.2 mm)	J-type (Ir/Ir)	13/16 in (20.8 mm)	
B7224	MHP spark plug	7/8-18 UNS	0.600 in (15.0 mm)	J-type (Ir/Ir)	13/16 in (20.8 mm)	L2252IP, 7/8GZ9, RB212-1, RW80N
B7324	MHP spark plug	7/8-18 UNS	0.750 in (19.0 mm)	J-type (Ir/Ir)	13/16 in (20.8 mm)	7/8GZ11, RW78N, W18, R717
B7424	MHP spark plug	7/8-18 UNS	0.875 in (22.2 mm)	J-type (Ir/Ir)	13/16 in (20.8 mm)	L2282IP, RB114-1, RW77N, RW77PP, W77N

<sup>1)</sup> MOTORTECH MHP-Plugs only available in packs of 4 pcs.

<sup>2)</sup> Refer to current MHP-Plugs sales flyer for further cross references and notes.

<sup>3)</sup> Spark plug comes with longer terminal nut to have identical overall length as to be replaced spark plug.

Must be used on applications with ignition coils fixed on the cylinder head (e.g. CATERPILLAR G3500B/C, G3600, etc.)



# Spark Plugs & Accessories

For more information:



## MBP-Plugs

MOTORTECH BRIDGE SPARK PLUGS

Modern gas engines are permanently operating under absolute extreme conditions with an effective mean pressure of more than 20 bar, with highly corrosive fuels (H<sub>2</sub>S) and lean mixtures – simultaneously demanding longer life periods.

The MOTORTECH MBP1800 spark plug uses an innovative, highly solid electrode design, thus granting three times longer lifetimes than any traditional J-gap spark plug can do.

### General Features

- Long life
- New bridge electrode design
- Large spark surface area
- Double iridium electrodes
- Advanced welding process
- M18 thread

### Double Iridium Electrodes

The MBP1800's special double iridium electrode structure lead to a large spark surface area of 11 mm<sup>2</sup>/ 0.017 sq inch.

### Innovative Electrode Design

The bridge design offers two heat paths, maximizing the heat dissipation of the ground electrode, reducing the electrode wear out, thus extending the spark plug life period.

### Patented Welding Process

The electron beam welding is the most robust of all currently known welding processes. The vacuum environment and the precise electron beam provide for the best possible bi-metal connection.

### MOTORTECH Bridge Spark Plug

P/N <sup>1)</sup>	Supersedes	Description	Thread Size	Thread Reach	Electrode Design (Alloy)	HEX	Equivalent to
MBP1800		MBP spark plug	M18x1.5	0.795 in (20.2 mm)	Bridge-type (Ir/Ir)	7/8 in (22.2 mm)	FEDERAL MOGUL® FB78WW, ROLLS ROYCE® 710785

<sup>1)</sup> MOTORTECH MBP1800 spark plug only available in packs of 4 pcs.

<sup>2)</sup> Call MOTORTECH or your nearest MOTORTECH sales partner for information about the range of application.

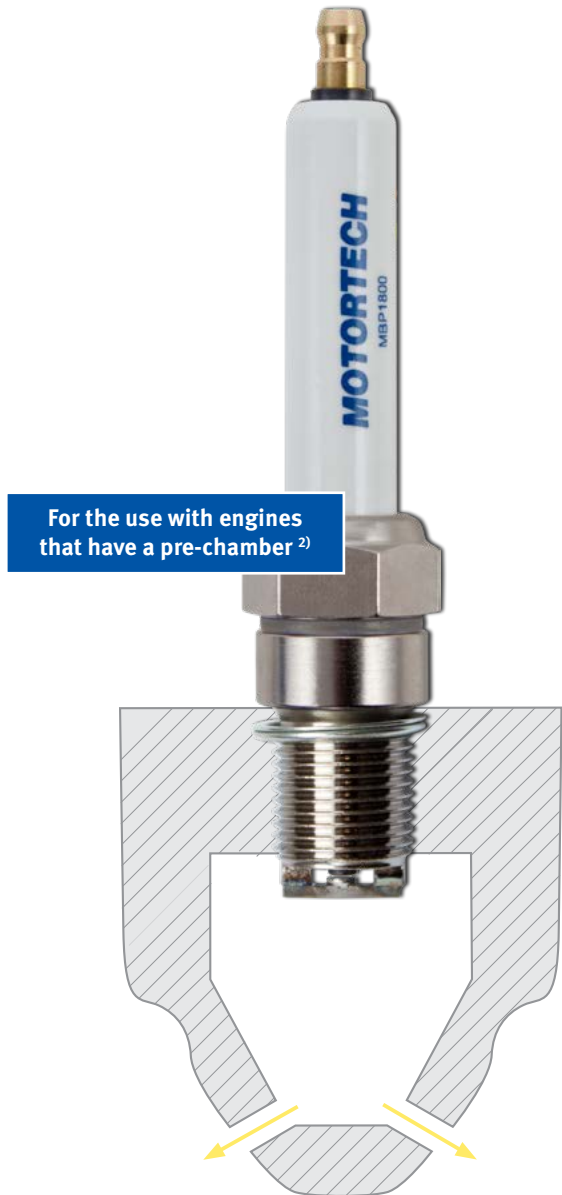

## MPC-Plugs

MOTORTECH PRE-CHAMBER SPARK PLUGS

MOTORTECH's pre-chamber spark plug MPC1900 is a cost-effective high performance solution for a wide variety of stationary gas engines. Its rigid design, specified for industrial applications, ensures long running times. The innovative design optimizes combustion in the engine, thus increasing efficiency and leading to improved emission values.

### General Features

- Iridium/Platinum alloy on center and ground electrode
- Resistant high quality ceramics made for best mechanical, thermal and electrical properties
- Laser technology makes a perfect alloy at the seam possible
- Hot locking technology guarantees high durability in high compression engines
- Monolithic resistor
- High quality steel shell, nickel-plated for excellent corrosion resistance
- Developed and manufactured in Germany



MBP1800 Bridge Spark Plug | MPC1900 Pre-Chamber Spark Plug

For more information:



### MOTORTECH Pre-Chamber Spark Plug

P/N <sup>1)</sup>	Supersedes	Description	Thread Size	Thread Reach	Electrode Design (Alloy)	HEX	Equivalent to <sup>2)</sup>
MPC1900	MPC1800	Pre-chamber spark plug	M18x1.5	0.724 in (18.4 mm)	Pre-Chamber (Ir/Pt)	13/16 in (20.8 mm)	346-5123, 284-8313, 199-9012, 18VGZ1-77, FB95WPV, X52404500049, X52404500039, X52404500027

<sup>1)</sup> MOTORTECH MPC1900 spark plug only available in packs of 4 pcs.

<sup>2)</sup> Call MOTORTECH or your nearest MOTORTECH sales partner for information about the range of application.

## ■ Spark Plugs & Accessories

### ICP-Plugs

MOTORTECH INTEGRAL IGNITION COIL SPARK PLUGS

For operators who prefer to use a long integral ignition coil, MOTORTECH manufactures the dual threaded spark plugs. For years these plugs have been successfully operated worldwide.

#### General Features

- Hot lock technology ensures increased spark plug durability even in high compression engines
- J-type electrode design for enhanced combustion
- Supplies even highest voltages of modern ignition systems like MOTORTECH's MIC series
- Special isolation for ceramic insulators for best flashover protection
- Advanced spark erosion resistance
- Suppression of electromagnetic interference (EMI)
- Less spark plug changes reduce operation costs
- Available with different thread sizes and reaches
  - M14x1.25
  - M18x1.5
  - 7/8-18 UNS (on request)

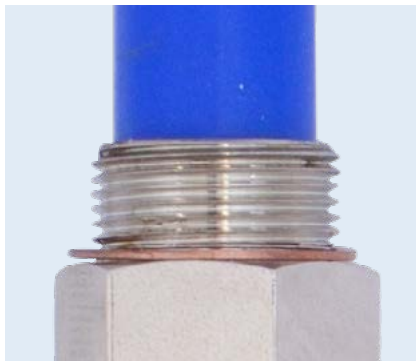

*13/16-20 UNEF top thread for coil connection with full 6 threads to meet the CSA requirements*



*Competitor top threads with only 4 threads do not meet the CSA requirements*

# Spark Plugs & Accessories



## Key Design Features

- 1 Additional silicone isolation on aluminum oxide ceramic insulator offers best flashover protection
- 2 Integrated stress resistant monolithic resistor suppresses electromagnetic interference (EMI)
- 3 13/16-20 UNEF top thread for coil connection with full 6 threads to meet the CSA requirements
- 4 Rigid welds
- 5 J-type electrode design and use of higher erosion resistance materials ensure better combustion particularly on lean burn gas engines and longest service life
- 6 Copper cored center electrode with laser welded IRIDIUM alloy disc
- 7 Copper cored ground electrode with laser welded IRIDIUM alloy disc

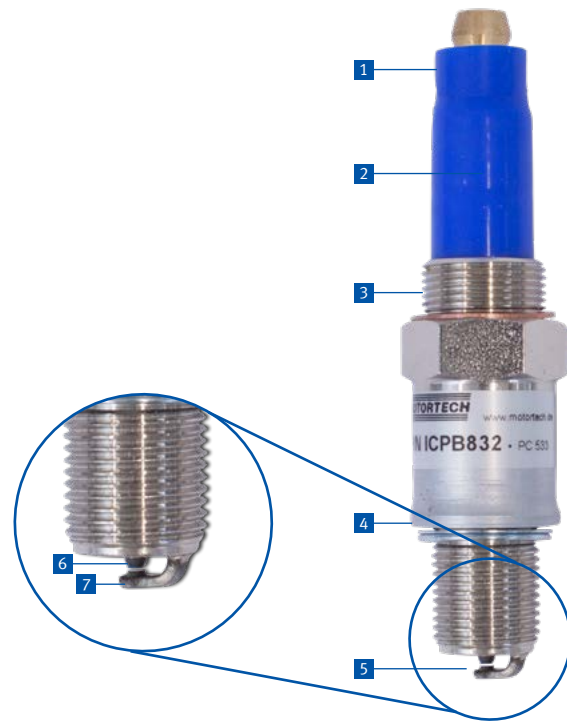

ICP-Plugs Integral Ignition Coil Spark Plugs

## Dual Threaded Spark Plugs for use with Integral Ignition Coils

P/N <sup>1)</sup>	Description	Thread Size	Thread Reach	Electrode Design	HEX	Thread Size Ignition Coil	Equivalent to
ICPB412	ICP spark plug	M14x1.25	0.500 in (12.7 mm)	J-type (Ir/Ir)	15/16 in (23.8 mm)	13/16-20 UNEF	RTL85G, 9Y-3985
ICPB432	ICP spark plug	M14x1.25	0.750 in (19.0 mm)	J-type (Ir/Ir)	15/16 in (23.8 mm)	13/16-20 UNEF	RTN79G, 4W-2256, 7311S
ICPB812	ICP spark plug	M18x1.5	0.500 in (12.7 mm)	J-type (Ir/Ir)	15/16 in (23.8 mm)	13/16-20 UNEF	RTM77N, RTM77PP, RTM79, 60999G, 60999N, 18GZ34, 7303S
ICPB832	ICP spark plug	M18x1.5	0.750 in (19.0 mm)	J-type (Ir/Ir)	15/16 in (23.8 mm)	13/16-20 UNEF	RTB77WPCC, RTB80N

<sup>1)</sup> MOTORTECH ICP-Plugs only available in packs of 4 pcs.

## ■ Spark Plugs & Accessories

### MOTORTECH Extended Barrel Spark Plugs

For certain applications extended barrel spark plugs are required. For example when the operator cannot get a conventional spark plug down the narrow spark plug well, he will need a special product that allows him to torque the plug from the top end. MOTORTECH offers an improved product to the market. Several of the known problems of products made by competitors are eliminated.

Besides an increase in reliability the spark plug run time needed to be extended. To achieve this, MOTORTECH uses base spark plugs with Iridium alloy (J-type) on center and ground electrode. MOTORTECH extended barrel spark plugs can be ordered in different lengths, terminal styles or with an integrated ignition cable.

#### Features

- No more trapped air in the extension barrel
- No more condensation
- No internal flash over
- Built in ceramics
- High dielectric strength
- Rigid welds



*The **J-type** ground electrode ensures better combustion, particularly on lean burn gas engines.*

## XT-Plugs

MOTORTECH EXTENDED BARREL SPARK PLUGS

MOTORTECH XT-Plugs are available with three different terminal styles to be connected directly to a spark plug lead or a short integral ignition coil.

The “**S2-Type**” has a 3/4 in male thread and 2 in termination well depth and used to be called the AIRCRAFT STYLE spark plug. This spark plug is designed to be connected to a shielded spark plug lead.

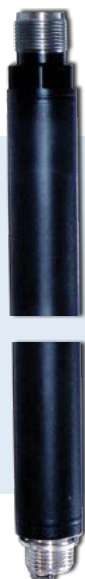

The “**DCP-Type**” has a female thread to adapt to a short integral ignition coil. This combination is popular in applications, where customers have had bad experiences with shielded spark plug leads.



The “**C-Type**” is an extended barrel plug that has a conventional ceramic insulator on the top end. This allows the use of a standard spark plug lead. Preferable the connector includes a 5 kΩ resistor to suppress electromagnetic interference (EMI).



# Spark Plugs & Accessories



Specification Table

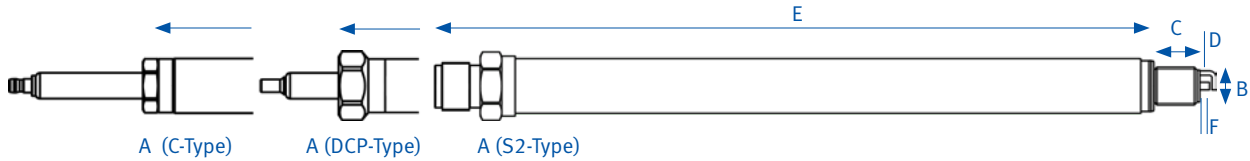

P/N A B C D E - F

A	Spark Plug Style
C	C-Type – for use with spark plug leads
DCP	DCP-Type – for use with integral ignition coils
S2	S2-Type – for use with shielded spark plug leads or unshielded safety leads

B	C	D	Thread Size	Thread Reach	Electrode Design
B4	1	2	M14x1.25	0.500 in (12.7 mm)	J-type (Ir/Ir)
B4	3	2	M14x1.25	0.750 in (19.0 mm)	J-type (Ir/Ir)
B8	1	2	M18x1.5	0.500 in (12.7 mm)	J-type (Ir/Ir)
B8	3	2	M18x1.5	0.750 in (19.0 mm)	J-type (Ir/Ir)
B8	5	2	M18x1.5	1.000 in (25.4 mm)	J-type (Ir/Ir)
B2	2	2	M22x1.5	0.600 in (15.0 mm)	J-type (Ir/Ir)
B2	3	2	M22x1.5	0.750 in (19.0 mm)	J-type (Ir/Ir)
B2	4	2	M22x1.5	0.875 in (22.2 mm)	J-type (Ir/Ir)
B7	2	2	7/8-18 UNS	0.600 in (15.0 mm)	J-type (Ir/Ir)
B7	3	2	7/8-18 UNS	0.750 in (19.0 mm)	J-type (Ir/Ir)
B7	4	2	7/8-18 UNS	0.875 in (22.2 mm)	J-type (Ir/Ir)

E	Extended Barrel Length – Other lengths available on request
BEX6	6 in
BEX8	8 in
BEX10	10 in
BEX12	12 in
BEX16	16 in

F	Electrode Gap
010	0.010 in (0.25 mm)
012	0.012 in (0.30 mm)
014	0.014 in (0.35 mm)

optional

Recommended Tightening Torque <sup>1)</sup>		
Thread Size	Tightening Torque (Cast Iron Head)	
M14x1.25	30 to 40 Nm	22 to 29 lb-ft
M18x1.5	50 to 60 Nm	37 to 44 lb-ft
M22x1.5	70 to 80 Nm	52 to 59 lb-ft
7/8-18 UNS	70 to 80 Nm	52 to 59 lb-ft

<sup>1)</sup> Please observe the tightening torques rendered by each engine manufacturer.

Conversion 1 inch = 25,4 mm / 1 foot = 0,3 m



# Spark Plugs & Accessories

UNSHIELDED

## XTL-Plugs

MOTORTECH EXTENDED BARREL SPARK PLUGS

Based on the concept of the extended barrel spark plugs, MOTORTECH offers another style of spark plugs. MOTORTECH XTL-Plugs are manufactured with an integrated 7 mm ignition cable, which allows a direct connection to an externally mounted ignition coil.

MOTORTECH XTL-Plugs can be ordered with different barrel and cable lengths and a wide range of ignition coil connectors. This guarantees a custom-made spark plug which definitely fits your application.

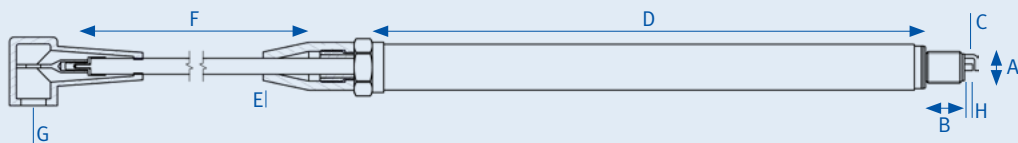

### Available Connectors to Ignition Coil



5A = ALTRONIC® style; 5B = BENDIX® style; 5C = MOTORTECH style; 5E = ALTRONIC® style – CPU XL

Specification Table – for unshielded Applications

A	B	C	Thread Size	Thread Reach	Electrode Design
B4	1	2	M14x1.25	0.500 in (12.7 mm)	J-type (Ir/Ir)
B4	3	2	M14x1.25	0.750 in (19.0 mm)	J-type (Ir/Ir)
B8	1	2	M18x1.5	0.500 in (12.7 mm)	J-type (Ir/Ir)
B8	3	2	M18x1.5	0.750 in (19.0 mm)	J-type (Ir/Ir)
B8	5	2	M18x1.5	1.000 in (25.4 mm)	J-type (Ir/Ir)
B2	2	2	M22x1.5	0.600 in (15.0 mm)	J-type (Ir/Ir)
B2	3	2	M22x1.5	0.750 in (19.0 mm)	J-type (Ir/Ir)
B2	4	2	M22x1.5	0.875 in (22.2 mm)	J-type (Ir/Ir)
B7	2	2	7/8-18 UNS	0.600 in (15.0 mm)	J-type (Ir/Ir)
B7	3	2	7/8-18 UNS	0.750 in (19.0 mm)	J-type (Ir/Ir)
B7	4	2	7/8-18 UNS	0.875 in (22.2 mm)	J-type (Ir/Ir)

D	Extended Barrel Length – Other lengths available on request
BEX6	6 in
BEX8	8 in
BEX10	10 in
BEX12	12 in
BEX16	16 in

E	Cable Output from Extended Barrel
B	180°

F	Cable Length – Other lengths available on request
8	8 in
10	10 in
12	12 in
14	14 in
16	16 in
18	18 in

G	Ignition Coil Connector	
1	Non CSA	ALTRONIC® Style – male, 180°
1A	Non CSA	ALTRONIC® Style – female, 180°, with spreading adaptor
2	Non CSA	MOTORTECH Style – M6, 90°
3	Non CSA	ALTRONIC® Style – male, 180°
4	Non CSA	ALTRONIC® Style – female, 90°
5A	CSA	ALTRONIC® Style – Externally Mounted – 3/4-20 UNEF
5B	CSA	BENDIX® Style – Externally Mounted – 3/4-20 UNEF
5C	CSA	MOTORTECH Style – Externally Mounted – 1-20 UNEF
5E	CSA	ALTRONIC® Style – CPU-XL – Ignition Coil P/N 591401-1
6	Non CSA	ALTRONIC® Style – male, 90°
7	Non CSA	New MOTORTECH Style – M6, 180°
8	Non CSA	ALTRONIC® Style – female, 90°
9	Non CSA	FAIRBANKS MORSE®-Style – male – no boot

H	Electrode Gap
010	0.010 in (0.25 mm)
012	0.012 in (0.30 mm)
014	0.014 in (0.35 mm)

P/N A B C D E F G H

Recommended Tightening Torque <sup>1)</sup>		
Thread Size	Tightening Torque (Cast Iron Head)	
M14x1.25	30 to 40 Nm	22 to 29 lb-ft
M18x1.5	50 to 60 Nm	37 to 44 lb-ft
M22x1.5	70 to 80 Nm	52 to 59 lb-ft
7/8-18 UNS	70 to 80 Nm	52 to 59 lb-ft

<sup>1)</sup> Please observe the tightening torques rendered by each engine manufacturer.

*optional*

Conversion 1 inch = 25,4 mm / 1 foot = 0,3 m

**NEW**

## Spark Plugs & Accessories

SHIELDED

# XTL-Plugs

MOTORTECH EXTENDED BARREL SPARK PLUGS

MOTORTECH XTL-Plugs are also available for shielded applications. To meet CSA requirements, this type of spark plug is fitted with an integrated and specially designed ignition cable. This is also known from MOTORTECH's MOT-Blues shielded spark plug leads. The multilayer design ensures that no humidity can be trapped in the ignition cable.

MOTORTECH XTL-Plugs can be ordered with different barrel and cable lengths and suitable ignition coil connectors, to allow direct connection to a shielded ignition coil. This guarantees a custom-made spark plug which definitely fits your application.

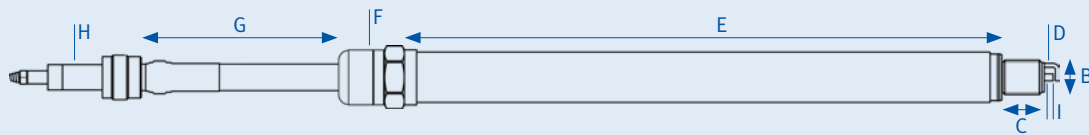

The specially designed ignition cable consists of a multilayer design:

- Nickel plated copper core
- 2 layers of silicone
- Stainless steel braid
- Silicone jacket

# Spark Plugs & Accessories



Specification Table – for shielded Applications

A		Spark Plug Style	
I		Shielded Application	

B	C	D	Thread Size	Thread Reach	Electrode Design
B4	1	2	M14x1.25	0.500 in (12.7 mm)	J-type (Ir/Ir)
B4	3	2	M14x1.25	0.750 in (19.0 mm)	J-type (Ir/Ir)
B8	1	2	M18x1.5	0.500 in (12.7 mm)	J-type (Ir/Ir)
B8	3	2	M18x1.5	0.750 in (19.0 mm)	J-type (Ir/Ir)
B8	5	2	M18x1.5	1.000 in (25.4 mm)	J-type (Ir/Ir)
B2	2	2	M22x1.5	0.600 in (15.0 mm)	J-type (Ir/Ir)
B2	3	2	M22x1.5	0.750 in (19.0 mm)	J-type (Ir/Ir)
B2	4	2	M22x1.5	0.875 in (22.2 mm)	J-type (Ir/Ir)
B7	2	2	7/8-18 UNS	0.600 in (15.0 mm)	J-type (Ir/Ir)
B7	3	2	7/8-18 UNS	0.750 in (19.0 mm)	J-type (Ir/Ir)
B7	4	2	7/8-18 UNS	0.875 in (22.2 mm)	J-type (Ir/Ir)

E	Extended Barrel Length – Other lengths available on request
BEX6	6 in
BEX8	8 in
BEX10	10 in
BEX12	12 in
BEX16	16 in

F	Cable Output from Extended Barrel
B	180°

G	Cable Length – Other lengths available on request
8	8 in
10	10 in
12	12 in
14	14 in
16	16 in
18	18 in

H	Ignition Coil Connector
5A	CSA ALTRONIC® Style – Externally Mounted – 3/4-20 UNEF
5B	CSA BENDIX® Style – Externally Mounted – 3/4-20 UNEF
5C	CSA MOTORTECH Style – Externally Mounted – 1-20 UNEF
5E	CSA ALTRONIC® Style – CPU-XL – Ignition Coil P/N 591401-1

I	Electrode Gap
010	0.010 in (0.25 mm)
012	0.012 in (0.30 mm)
014	0.014 in (0.35 mm)

Recommended Tightening Torque <sup>1)</sup>		
Thread Size	Tightening Torque (Cast Iron Head)	
M14x1.25	30 to 40 Nm	22 to 29 lb-ft
M18x1.5	50 to 60 Nm	37 to 44 lb-ft
M22x1.5	70 to 80 Nm	52 to 59 lb-ft
7/8-18 UNS	70 to 80 Nm	52 to 59 lb-ft

<sup>1)</sup> Please observe the tightening torques rendered by each engine manufacturer.

**NEW**

*optional*

XTL-Plugs Extended Barrel Spark Plugs

# Spark Plugs & Accessories

## Spark Plug Tools

### Spark Plug Cleaning Kit

Regular maintenance is required to achieve the maximum service life in particular with high price spark plugs with precious metal alloys.

Apart from readjusting the electrode gap, the spark plug should also be freed from deposits and residues that have formed during operation. By using the MOTORTECH spark plug cleaning kit these impurities can be removed easily and gently in the electrode area and on the thread within a regular maintenance interval.

This will increase spark plug service life and cut maintenance costs.



### Features

- Professional cleaning of spark plugs without pre-chamber
- Different nozzle sizes matching M14, M18, M22, and 7/8 spark plugs
- Oil residues and deposits in the electrode area are removed without residues by high pressure
- Special blasting grit for gentle cleaning of the electrode and thread area
- Blasting grit is captured and can be reused
- No dust development

### Scope of Delivery

The spark plug cleaning kit is supplied with the following parts:

- Spark plug cleaning device with compressed air quick release coupling, blasting grit container and dust collector bag
- Cleaning nozzles for M14, M18, M22 and 7/8 spark plugs
- Blasting grit, 1 kg, in separate container
- Operating manual
- Hard shell carrying case with foam insert

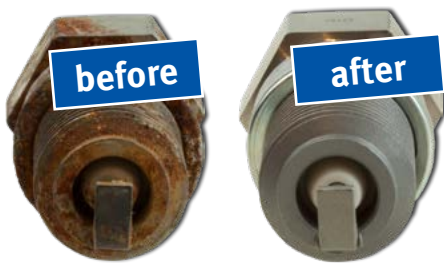

P/N	Supersedes	Description
44.01.023	44.01.000	Spark plug cleaning kit

### Subcomponents

P/N	Supersedes	Description
44.01.009		Blasting grit, 1 kg
44.01.024	44.01.005	Cleaning nozzles, kit for M14, M18, M22 and 7/8 spark plugs
44.01.025	44.01.006	Dust collector bag for spark plug cleaning device

# ■ Spark Plugs & Accessories



## MOTORTECH Spark Plug Gap Setting Tool

The gap between the center and ground electrodes is of fundamental importance for clean combustion as well as the optimal functioning of any spark plug. During the operation of a gas engine, however, the gap between the electrodes can increase, e.g. because of spark erosion, which can lead to increased voltage requirements or even misfiring.

The electrode gap should be re-adjusted at regular maintenance intervals in order to maximize the service life of spark plugs, especially for high-priced industrial spark plugs.

### Features

- Simple-to-use tool for setting the electrode gap on different spark plug types
- The quick-release lock of the thread adaptor ensures that spark plugs can be changed quickly
- The tool is hand-operated and does not need to be additionally mounted on a workbench
- The spark plug gap setting tool can be custom-configured with optionally available accessory components
- The tool and all accessories can be stowed in the included carrying case
- Transportable, which makes it ideal for service companies

### Functional Description (Example J-Type Spark Plug)



**1** The tool is first fitted with the base insert that fits the corresponding spark plug.



**2** Thread adaptors are available in various sizes for the spark plugs that need to be set (M14, M18, 7/8-18 or M22). The adaptors can be mounted or exchanged easily with the included screws and the hex key.



**3** The integrated quick-release lock guarantees rapid changes and secure holding of the spark plugs while they are being set.



**4** Light pressure on the lever is enough to set the electrode gap to the desired distance with the help of a feeler gauge.

MOTORTECH's innovative spark plug gap setting tool provides every gas engine operator or employee of a service company with a smart tool to professionally adjust the electrode gap on-site in a material-conserving manner.





# Spark Plugs & Accessories

## Spark Plug Gap Setting Tool – Basic Kits <sup>1)</sup>

P/N	Figure	Supersedes	Description
07.98.120-14	1	07.98.113	Spark plug gap setting tool, basic kit including thread adaptor for spark plugs with M14x1.25 thread
07.98.120-18	1	07.98.113	Spark plug gap setting tool, basic kit including thread adaptor for spark plugs with M18x1.5 thread
07.98.120-78	1	07.98.113	Spark plug gap setting tool, basic kit including thread adaptor for spark plugs with M22x1.5 and 7/8-18 UNS thread

<sup>1)</sup> Needs appropriate accessory kit in addition.

## Spark Plug Gap Setting Tool – Thread Adaptors <sup>1)</sup>

P/N	Figure	Supersedes	Description
07.98.121-14	2		Thread adaptor for spark plugs with M14x1.25 thread
07.98.121-18	2		Thread adaptor for spark plugs with M18x1.5 thread
07.98.121-78	2		Thread adaptor for spark plugs with M22x1.5 and 7/8-18 UNS thread

<sup>1)</sup> Can be ordered separately in addition to chosen basic kit.

## Spark Plug Gap Setting Tool – Accessory Kits <sup>1)</sup>

P/N	Figure	Supersedes	Description
07.98.122-A	3		Accessory kit for J-type spark plugs
07.98.122-B	3		Accessory kit for CHAMPION® N-type spark plugs
07.98.122-C	3		Accessory kit for BERU® spark plugs 18GZ44 (Z283), Super Blue Ignition (Z351)
07.98.122-D	3		Accessory kit for BERU® spark plug 18GZ46 (Z377)
07.98.122-E	3		Accessory kit for BERU® spark plug 18GZ47
07.98.122-F	3		Accessory kit for bridge spark plugs MBP1800, CHAMPION® FB78WW, ROLLS ROYCE® 710875
07.98.122-G	3		Accessory kit for MOTORTECH MHP spark plugs B2224 and B7224

**NEW**

<sup>1)</sup> Need to be ordered separately in addition to chosen basic kit.

## Feeler Gauges

P/N	Figure	Supersedes	Description	Size
07.98.131	4		Feeler gauge, 8 blades	0.002 to 0.020 in (0.05 to 0.50 mm)
07.98.037	5		Feeler gauge clamp tool	
07.98.059	6		Feeler gauge shim roll, 12.7 mm x 5.0 m	0.008 in (0.20 mm)
07.98.034	6		Feeler gauge shim roll, 12.7 mm x 5.0 m	0.010 in (0.25 mm)
07.98.035	6		Feeler gauge shim roll, 12.7 mm x 5.0 m	0.012 in (0.30 mm)
07.98.036	6		Feeler gauge shim roll, 12.7 mm x 5.0 m	0.014 in (0.35 mm)



1



2



3



4

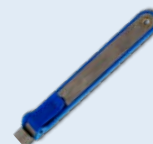

5



6

# Spark Plugs & Accessories



## MOTORTECH Extended Barrel Magnetic Spark Plug Sockets

When it comes to service of a gas engine, the exchange of a spark plug is one of the easier tasks. However there are a few things you need to consider. Especially with modern high-end spark plugs it is essential to carry out a service with a tool for professionals and to avoid damage when the spark plug is screwed in or out.

MOTORTECH offers a complete range of extended barrel magnetic spark plug sockets in various lengths for all types of HEX. Integrated strong magnets hold the spark plug securely in any position, which guarantees an easy assembly and disassembly work especially on large engines with deep spark plug wells.

### Features

- Strong magnets for firm connection of the spark plug
- Use of magnets ensures largest possible clearance spark plug ceramic insulator
- Equipped with a cross knurl, the sockets are extremely handy and non-slip
- Different lengths for use with various engine applications
- 1/2 inch drive

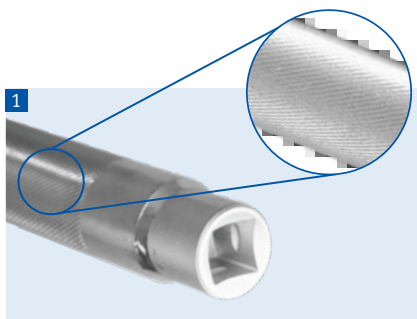
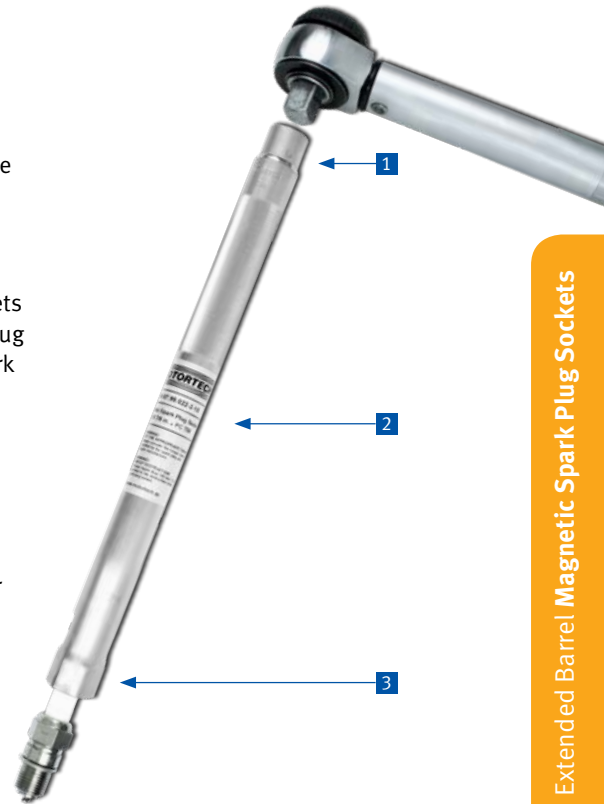

1/2 inch drive and cross knurled surface



Standard lengths 6, 12, 16, 18 and 20 inch



Integrated magnets

Spark Plug Gap Setting Tool | Extended Barrel Magnetic Spark Plug Sockets

### Extended Barrel Magnetic Spark Plug Sockets – Standard Versions

P/N <sup>1)</sup>	Description	HEX	Outer Dimensions max.	Drive	Typical used Spark Plugs
07.99.022-5-L	Magnetic spark plug socket	5/8 in (16.0 mm)	0.82 in (20.8 mm)	1/2 in	14FR-4DIU, B4321, GK3-1, GK3-5, RC78PYP, FC86WWCC
07.99.022-4-L	Magnetic spark plug socket	13/16 in (20.8 mm)	1.09 in (27.8 mm)	1/2 in	14R-4DIU, FN8xWWCC, 14GZ-LL, 18GZ5-77-2, B8124, B8324, GE2-3, GE3-1, GE3-5, GL3-3, GL3-5, RB75WPCC, RN79G"
07.99.022-3-L	Magnetic spark plug socket	7/8 in (22.2 mm)	1.14 in (29.0 mm)	1/2 in	18GZ6-77-2, FB77WPCC, GI3-1, GI3-3, GI3-5, RHL79G, RM77N, RTB77WPCC, RTM77N
07.99.022-2-L	Magnetic spark plug socket	15/16 in (23.8 mm)	1.24 in (31.5 mm)	1/2 in	7/8GZ9, 7/8GZ11, ICPB432, ICPB812, ICPB832, RTL85G, RTN79G, RW80PP, W80N
07.99.022-1-L	Magnetic spark plug socket	1 in (25.4 mm)	1.34 in (34.0 mm)	1/2 in	18GZ34, K97F, W77N

<sup>1)</sup> Standard barrel lengths (-L) = 6 in, 12 in, 16 in, 18 in. Other lengths available on request

## Spark Plugs & Accessories

### Extended Barrel Magnetic Spark Plug Sockets – Special Versions

P/N	Supersedes	Description	HEX	Drive
07.99.022-3-36		Magnetic spark plug socket – NORDBERG®	7/8 in (22.2 mm)	1/2 in
07.99.022-4-6	07.99.022-6-6	Magnetic spark plug socket – MAN® E0836LE/E28 series	13/16 in (20.8 mm)	1/2 in
07.99.022-4-10	07.99.022-6-10	Magnetic spark plug socket – MAN® E32 series	13/16 in (20.8 mm)	1/2 in

### Spark Plug Socket for MOTORTECH XTL-Plugs (unshielded Applications)

P/N	Supersedes	Description	HEX	Drive
07.99.022-6-2		Spark plug socket	7/8 in (22.2 mm)	1/2 in

### Torque Wrench

P/N	Supersedes	Description	Torque	Drive
07.98.065	07.98.063	Torque wrench	7.4 to 74 lb-ft (10 to 100 Nm)	1/2 in

### Seat & Thread Reconditioners

Use seat & thread reconditioner to clean cylinder head threads and seal seats in one operation.

P/N	Supersedes	Description	Thread Size	Thread Reach
07.98.114-12	07.98.022	Seat & thread reconditioner	M14x1.25	1/2 in
07.98.114-34	07.98.023	Seat & thread reconditioner	M14x1.25	3/4 in
07.98.118-12	07.98.024	Seat & thread reconditioner	M18x1.5	1/2 in
07.98.118-34	07.98.025	Seat & thread reconditioner	M18x1.5	3/4 in
07.98.178-58	07.98.026	Seat & thread reconditioner	7/8-18 UNS	5/8 in
07.98.178-78	07.98.026-1	Seat & thread reconditioner	7/8-18 UNS	7/8 in

### Extended Barrel Seat & Thread Reconditioners – 1/2 Inch Drive

P/N	Supersedes	Description	Thread Size	Thread Reach
07.98.114-12-BEX6		Seat & thread reconditioner, 6 in length	M14x1.25	1/2 in
07.98.114-12-BEX12		Seat & thread reconditioner, 12 in length	M14x1.25	1/2 in
07.98.114-34-BEX6		Seat & thread reconditioner, 6 in length	M14x1.25	3/4 in
07.98.114-34-BEX12		Seat & thread reconditioner, 12 in length	M14x1.25	3/4 in
07.98.118-12-BEX6		Seat & thread reconditioner, 6 in length	M18x1.5	1/2 in
07.98.118-12-BEX12		Seat & thread reconditioner, 12 in length	M18x1.5	1/2 in
07.98.118-34-BEX6		Seat & thread reconditioner, 6 in length	M18x1.5	3/4 in
07.98.118-34-BEX12		Seat & thread reconditioner, 12 in length	M18x1.5	3/4 in
07.98.178-58-BEX6		Seat & thread reconditioner, 6 in length	7/8-18 UNS	5/8 in
07.98.178-58-BEX12		Seat & thread reconditioner, 12 in length	7/8-18 UNS	5/8 in
07.98.178-78-BEX6		Seat & thread reconditioner, 6 in length	7/8-18 UNS	7/8 in
07.98.178-78-BEX12		Seat & thread reconditioner, 12 in length	7/8-18 UNS	7/8 in

## Spark Plugs & Accessories



### Thread Plug Gauges – Go/No-Go **NEW**

P/N	Supersedes	Description	Thread Size	Equivalent to
07.98.064-14		Thread plug gauge (Go/No-Go)	M14x1.25	GNG-14
07.98.064-18		Thread plug gauge (Go/No-Go)	M18x1.5	GNG-18
07.98.064-78		Thread plug gauge (Go/No-Go)	7/8-18 UNS	GNG-78

### Extended Barrel Thread Plug Gauges – Go/No-Go **NEW**

P/N	Supersedes	Description	Thread Size	Equivalent to
07.98.076-BEX6		Thread plug gauge (Go/No-Go), 6 in length	M14x1.25	
07.98.076-BEX12		Thread plug gauge (Go/No-Go), 12 in length	M14x1.25	
07.98.076-BEX18		Thread plug gauge (Go/No-Go), 18 in length	M14x1.25	
07.98.077-BEX6		Thread plug gauge (Go/No-Go), 6 in length	M18x1.5	
07.98.077-BEX12		Thread plug gauge (Go/No-Go), 12 in length	M18x1.5	
07.98.077-BEX18		Thread plug gauge (Go/No-Go), 18 in length	M18x1.5	
07.98.078-BEX6		Thread plug gauge (Go/No-Go), 6 in length	7/8-18 UNS	
07.98.078-BEX12		Thread plug gauge (Go/No-Go), 12 in length	7/8-18 UNS	
07.98.078-BEX18		Thread plug gauge (Go/No-Go), 18 in length	7/8-18 UNS	



### Extended Barrel Thread-Cutting Taps **NEW**

P/N	Supersedes	Description	Thread Size	Drive	Equivalent to
07.98.066-BEX6		Thread cutting tap, 6 in length	M14x1.25	1/2 in	
07.98.066-BEX12		Thread cutting tap, 12 in length	M14x1.25	1/2 in	
07.98.066-BEX18		Thread-cutting tap, 18 in length	M14x1.25	1/2 in	
07.98.067-BEX6		Thread cutting tap, 6 in length	M18x1.5	1/2 in	
07.98.067-BEX12		Thread cutting tap, 12 in length	M18x1.5	1/2 in	
07.98.067-BEX18		Thread-cutting tap, 18 in length	M18x1.5	1/2 in	
07.98.068-BEX6		Thread-cutting tap, 6 in length	7/8-18 UNS	1/2 in	
07.98.068-BEX12		Thread-cutting tap, 12 in length	7/8-18 UNS	1/2 in	
07.98.068-BEX18		Thread-cutting tap, 18 in length	7/8-18 UNS	1/2 in	



### Installation & Service Kit for MOTORTECH XTL-Plugs

Spark plugs play a crucial role in an ignition system. Maintenance and, in particular, the correct handling of spark plugs is vital to ensure flawless functioning and long

service life. MOTORTECH provides an installation and service kit that is specially designed for XTL spark plugs with integrated spark plug lead and M14 thread.

P/N	Supersedes	Description	For Spark plugs with	
			Thread Size	Thread Reach
07.98.214-34		Installation & service kit for MOTORTECH XTL-Plugs	M14x1.25	3/4 in

# Spark Plugs & Accessories

## Spark Plug Accessories

### Gaskets for Spark Plugs

P/N	Description	For Thread Size	Quantity
02.85.015-100	Spark plug gasket	M14x1.25	100 pcs
02.85.016-100	Spark plug gasket	M18x1.5	100 pcs
02.85.017-100	Spark plug gasket	M22x1.5, 7/8-18 UNS	100 pcs



Spark plug gaskets just once provide an optimal seal between spark plug and seat. Spark plugs must be installed with a new gasket after every service in order to ensure the best possible seal in future operation.

### Gaskets for MOTORTECH ICP-Plugs

P/N	Description	Quantity
75.90.295-100	Spark plug gasket, copper	100 pcs



### Thread Lubricant

This lubricant is non-metallic and non-conductive. Guarantees easy spark plug removal and prevents thread damage. Also for use with seat & thread reconditioner.

P/N	Description	Equivalent to
07.98.718	Thread lubricant, 4 oz (115 g)	A718







## Gas Engine Control Systems

# DetCon

MOTORTECH DETONATION CONTROL SYSTEM

The gas engine operators are calling for increased power output from their engines. More load means higher temperatures, pressures and tougher operation. This mostly ends in catastrophic engine damages due to detonation or pre-ignition.

As MOTORTECH has proven for years, detonation can be detected professionally with the DetCon2 or Detcon20 detonation control system. Detonation sensors constantly monitor the sound level of the combustion. If detonation is detected the system will take steps to eliminate detonation immediately.

Upgrade your engine and increase availability of the equipment!



### Technical Benefits

- Prevents the engine from damages caused by knocking combustion
- Frequency range detonation sensors: 1-20 kHz
- Easy Installation and configuration via USB interface
- DenEdit software for visualization and adjustment of firing sequences, actual knocking values or knocking history with long-term data
- Available as a built-in device for a control cabinet or in a CSA-certified housing.
- DIN rail mounting
- Supply voltage: 9 – 36 VDC
- Can also be used on dual fuel and bi-fuel engines
- Protection class: IP 20

### Individual Characteristics <sup>1)</sup>

- DetCon2 is used with one detonation sensor for in-line engines, and with 2 sensors for V-engines (one per bank)
- DetCon20 is used with one sensor per cylinder and can process up to 20 detonation sensors

### Environmental Conditions

- Operation: -10° C to 60° C max. (14° F to 140° F)
- Storage: -40° C to 70° C max. (-40° F to 158° F)
- max. 95% humidity without condensation

### Interfaces

- USB 1.1 interface
- CAN Bus interface

### Scope of Supply

- DetCon detonation control system
- CD-ROM with software for configuring the device
- USB interface cable for connecting the device to a PC/laptop
- Operating manual
- Mounting kit (model with housing)

### Recommended Accessories

- AlphaRail wiring rails for easy installation
- PowerView3 for complete visualization of detonation data

<sup>1)</sup> Consult factory for deviating configurations

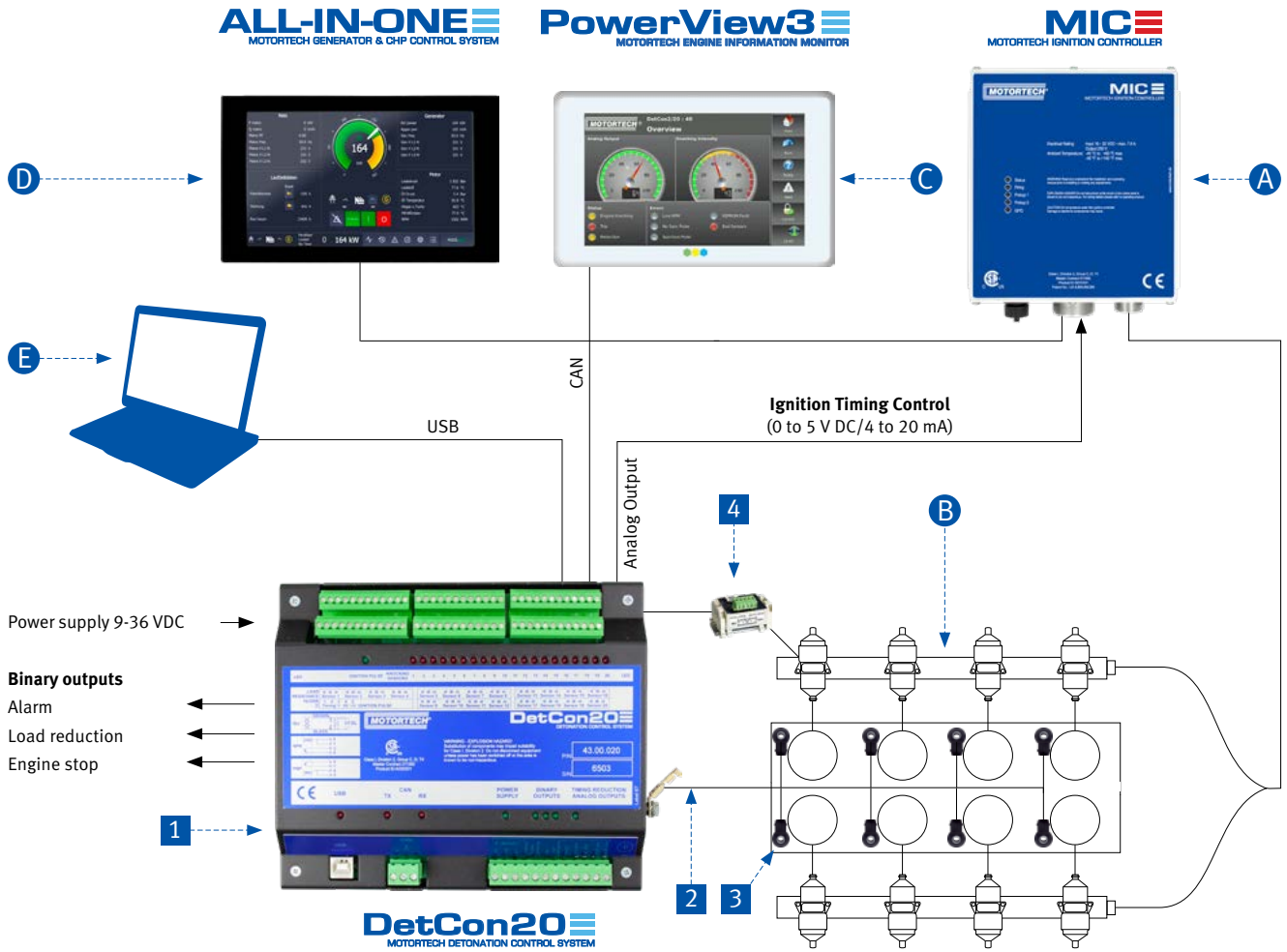

## Required components

- 1 DetCon – detonation control system
- 2 Detonation sensor wiring
- 3 Detonation sensor
- 4 ISU ignition sensor unit  
not required with MIC3/3+, MIC4, MIC5, MIC6, MIC850

## Description

- A Ignition controller
- B Wiring rail (ignition)
- C PowerView3 <sup>1)</sup>
- D ALL-IN-ONE <sup>1)</sup>
- E Laptop

<sup>1)</sup> Visualization via MOTORTECH PowerView3, alternatively with MOTORTECH ALL-IN-ONE

# Gas Engine Control Systems



## 1 DetCon20 Control Units

P/N	Description
43.00.020 <sup>1)</sup>	DetCon20 control unit, 20 inputs, CSA, IP20
43.00.120	DetCon20 control unit, 20 inputs, built into an CSA enclosure, includes ISU ignition sensor unit P/N 43.20.002
43.00.220 <sup>2)</sup>	DetCon20 control unit, 20 inputs, built into an CSA enclosure

<sup>1)</sup> The control unit has to be installed in (CSA approved) control panel or enclosure.

<sup>2)</sup> For use with MIC3/3+, MIC4, MIC5, MIC6 and MIC850 series ignition controllers. Ignition sensor unit is not required.



## DetCon20 Detonation Control Kits

P/N <sup>1)</sup>	Description
43.00.020-04	DetCon20 detonation control kit, incl. DetCon20 control unit, detonation sensor lead P/N 43.30.004-60 (4 pcs), detonation sensor P/N 43.20.001 (4 pcs)
43.00.020-06	DetCon20 detonation control kit, incl. DetCon20 control unit, detonation sensor lead P/N 43.30.004-60 (6 pcs), detonation sensor P/N 43.20.001 (6 pcs)
43.00.020-08	DetCon20 detonation control kit, incl. DetCon20 control unit, detonation sensor lead P/N 43.30.004-60 (8 pcs), detonation sensor P/N 43.20.001 (8 pcs)
43.00.020-12	DetCon20 detonation control kit, incl. DetCon20 control unit, detonation sensor lead P/N 43.30.004-60 (12 pcs), detonation sensor P/N 43.20.001 (12 pcs)
43.00.020-16	DetCon20 detonation control kit, incl. DetCon20 control unit, detonation sensor lead P/N 43.30.004-60 (16 pcs), detonation sensor P/N 43.20.001 (16 pcs)
43.00.020-20	DetCon20 detonation control kit, incl. DetCon20 control unit, detonation sensor lead P/N 43.30.004-60 (20 pcs), detonation sensor P/N 43.20.001 (20 pcs)

<sup>1)</sup> If required, ISU ignition sensor unit needs to be ordered separately.



## 2 DetCon2 Control Units

P/N	Description
43.00.002 <sup>1)</sup>	DetCon2 control unit, 2 inputs, CSA, IP20
43.00.102	DetCon2 control unit, 2 inputs, built into an CSA enclosure, includes ISU ignition sensor unit P/N 43.20.002
43.00.202 <sup>2)</sup>	DetCon2 control unit, 2 inputs, built into an CSA enclosure

<sup>1)</sup> The control unit has to be installed in (CSA approved) control panel or enclosure.

<sup>2)</sup> For use with MIC3/3+, MIC4, MIC5, MIC6 and MIC850 series ignition controllers. Ignition sensor unit is not required.



1



2

### 3 Detonation Sensor Lead (1 per Detonation Sensor required)

P/N	Description
43.30.004-60	Detonation sensor lead, 60 ft (18 m)

### 4 Detonation Sensor (1 per Cylinder required)

P/N	Description
43.20.001	Detonation sensor w/o lead, 2 pole

### 5 Engine Specific Cylinder Head Screws prepared for Detonation Sensor (1 per Cylinder required) <sup>1)</sup>

P/N	Description	Application
236-0484-DS	Cylinder head screw CATERPILLAR® P/N 236-0484, prepared, incl. mounting screw for detonation sensor	CATERPILLAR® G3406, G3408/C, G3412/C
51.90020-0381-DS	Cylinder head screw MAN® P/N 51.90020-0381, prepared, incl. mounting screw for detonation sensor	MAN® E08 series
51.90490-0022-DS	Cylinder head screw MAN® P/N 51.90490-0022, prepared, incl. mounting screw for detonation sensor	MAN® E28 series
51.90020-0470-DS	Cylinder head screw MAN® P/N 51.90020-0470, prepared, incl. mounting screw for detonation sensor	MAN® E26, E32 series
169994B-DS	Cylinder head screw WAUKESHA® P/N 169994B, prepared, incl. mounting screw for detonation sensor	WAUKESHA® VHP series
305948A-DS	Cylinder head screw WAUKESHA® P/N 305948A, prepared, incl. mounting screw for detonation sensor	WAUKESHA® VGF series

<sup>1)</sup> Please observe the installation instructions rendered by each engine manufacturer.



3



4



5

# Gas Engine Control Systems

Detonation Sensor Adaptor for **MWM®/DEUTZ®** 604/620 Series Gas Engines (1 per Detonation Sensor required)

P/N	Description
43.20.018	Detonation sensor adaptor

ISU Ignition Sensor Unit (1 per System required) <sup>1)</sup>

P/N	Description
43.20.002	ISU ignition sensor unit

<sup>1)</sup> Not required if MIC3/3+, MIC4, MIC5, MIC6, MIC850 or DetCon20 control unit P/N 43.00.102 or 43.00.120 is used.

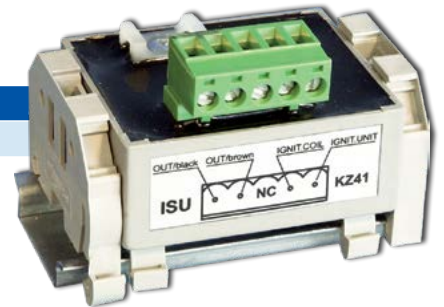

## PowerView3 MOTORTECH ENGINE INFORMATION MONITOR

### Detonation Control Visualization

The operating data of the DetCon Detonation Control system will be completely visualized via HMI module (Human Machine Interface). The overview screen shows the relevant information as engine knocking, knock intensity and status for activated load reduction or emergency shutdown of engine.

The control keys guarantee simple navigation through the different display pages and menus. All in all the PowerView3 HMI module is also able to provide error diagnostics on-site without requiring a laptop!

The PowerView3 is also available for data visualization of:

- MIC Ignition Control (MIC3/3+, MIC4 and MIC5 series)
- TempScan20 Temperature Module



1

### Sample Screens



#### Overview

Screen shows the most important operating data of the connected DetCon control unit.

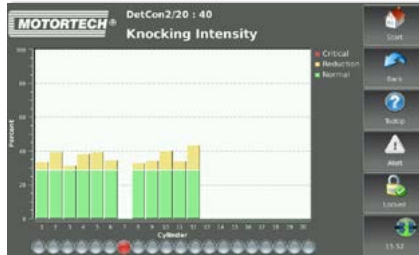

#### Knocking Intensity

Visualization of knocking intensity of each monitored cylinder. Different colors inform about the system status (Normal – Reduction – Critical).

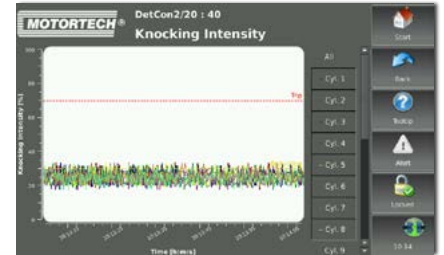

#### Trending Knocking Intensity

Visualization of knocking intensity trend data for each individual cylinder.

### PowerView3 HMI Modules & Activation Codes



P/N	Figure	Description
06.05.085	1	PowerView3 HMI module
06.05.185	2	PowerView3 HMI module, built into stainless steel enclosure
06.05.187	3	PowerView3 HMI module, built into steel enclosure with sight window
06.05.087-F		PowerView3 activation code for visualization of DetCon data – Activation code has to be ordered separately with each PowerView3 HMI module
06.05.087-U		PowerView3 activation code for visualization of DetCon data – Only available for upgrade of existing PowerView3 HMI module in the field





# Gas Engine Control Systems



## Wiring Rail System for Detonation Control

MOTORTECH stainless steel, vibration resistant rail assembly will withstand any harsh environment commonly found in the oil & gas industry. The proven design is made for engine manufacturers and the global aftermarket. Do not go low-tech and take the risk of engine down time because of equipment being under repair. Eliminate the need for constant rewiring, connector exchanges or straightening out weak and bent aluminum wiring rails.

- Made of stainless steel which performs better than aluminum in harsh environments (and where operators use any kind of equipment to hold or stand on)
- Made to perfectly fit the application
- Rigid military style connectors are securely fastened into the stainless steel rail
- Rails are filled with special foam to ensure that all wires are separated from ground and will not vibrate and eventually short out to ground
- Water proof design – built to last in uncovered environment
- Repairable by MOTORTECH's assigned distributors in the event of mechanically damage

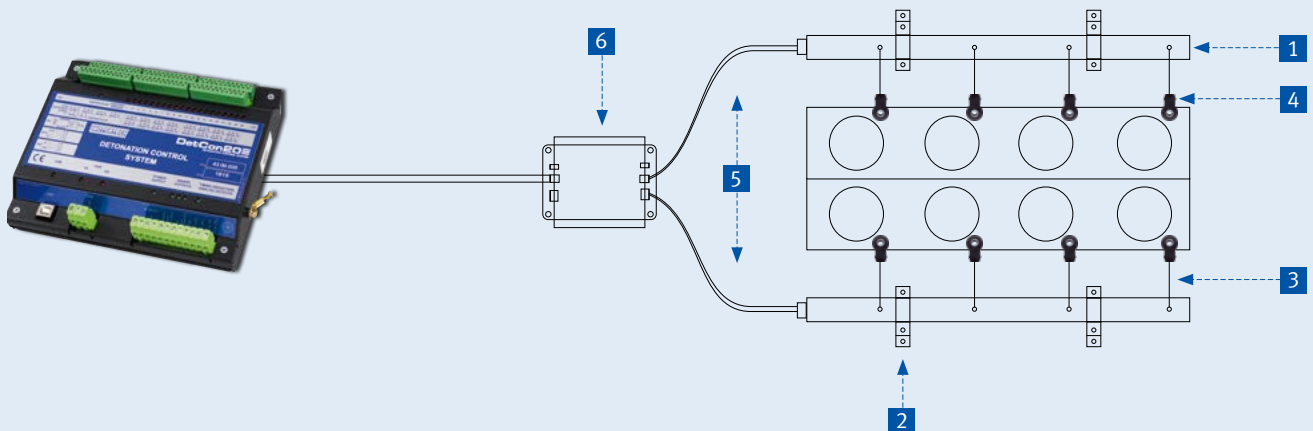
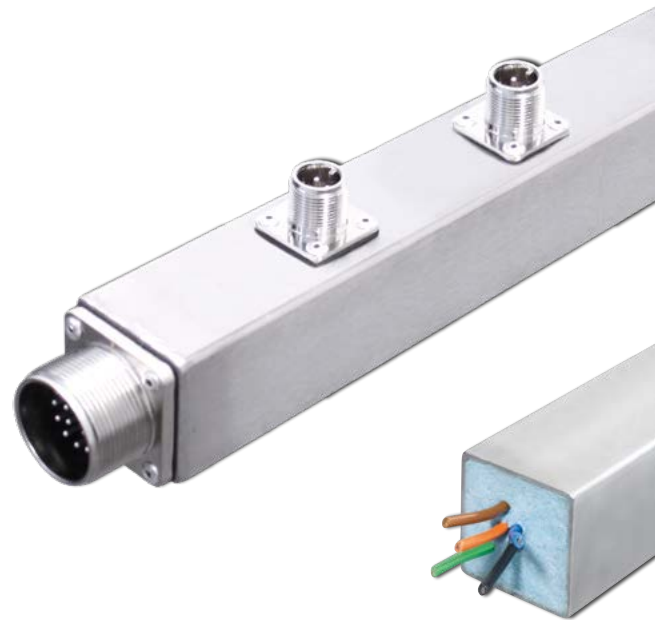

## 1 AlphaRail for Detonation Control – Specification Table

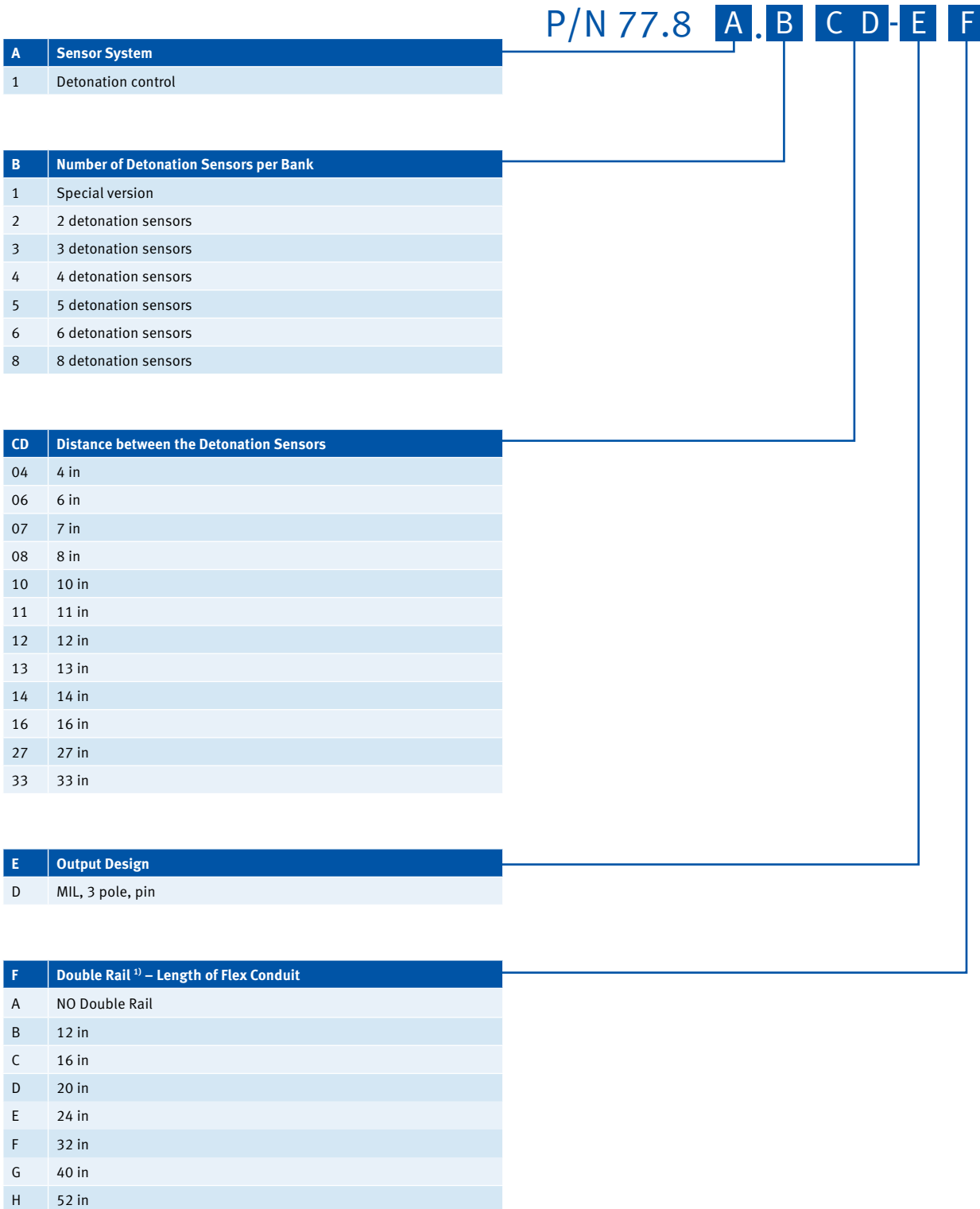

<sup>1)</sup> Two wiring rails connected by flex conduit.



### 1 AlphaRail for Detonation Control – Wiring Rails for common Applications <sup>1)</sup>

P/N	Description	Engine Make	Model	Required Quantity per Engine	Equivalent to
77.81.406-DA	AlphaRail wiring rail	CATERPILLAR®	G3304	1	
77.81.606-DA	AlphaRail wiring rail	CATERPILLAR®	G3306	1	
77.81.607-DA	AlphaRail wiring rail	CATERPILLAR®	G3406	1	
77.81.407-DA	AlphaRail wiring rail	CATERPILLAR®	G3408	2	
77.81.607-DA	AlphaRail wiring rail	CATERPILLAR®	G3412	2	
77.81.411-DA	AlphaRail wiring rail	CATERPILLAR®	G3508	2	
77.81.611-DA	AlphaRail wiring rail	CATERPILLAR®	G3512	2	
77.81.811-DA	AlphaRail wiring rail	CATERPILLAR®	G3516	2	
77.81.631-DG	AlphaRail wiring rail	CLARK®	HBA-6T	1	
77.81.531-DA	AlphaRail wiring rail	CLARK®	HBA-10T	2	
77.81.637-DA	AlphaRail wiring rail	CLARK®	TCVD-12	2	
77.81.631-DG	AlphaRail wiring rail	CLARK®	TLA-6T	1	
77.81.544-DG	AlphaRail wiring rail	COOPER®	GMVH-10	2	
77.81.541-DG	AlphaRail wiring rail	COOPER®	GMW-10	2	
77.81.340-DA	AlphaRail wiring rail	COOPER®	GMWC-6	2	
77.81.822-DG	AlphaRail wiring rail	COOPER®	LSV-16	2	
77.81.633-DF	AlphaRail wiring rail	INGERSOLL RAND®	KVR-412	2	
77.81.344-DA	AlphaRail wiring rail	INGERSOLL RAND®	KVS-6	2	
77.81.427-DD	AlphaRail wiring rail	INGERSOLL RAND®	PKVG-8	2	
77.81.627-DD	AlphaRail wiring rail	INGERSOLL RAND®	PKVG-12	2	
77.81.627-DF	AlphaRail wiring rail	INGERSOLL RAND®	PKVGR-12	2	
77.81.437-DA	AlphaRail wiring rail	INGERSOLL RAND®	XVG-8	2	
77.81.606-DA	AlphaRail wiring rail	WAUKESHA®	F817	1	
77.81.614-DA	AlphaRail wiring rail	WAUKESHA®	F1197GL/GU	1	
77.81.608-DA	AlphaRail wiring rail	WAUKESHA®	VG F18	1	
77.81.808-DA	AlphaRail wiring rail	WAUKESHA®	VG F24	1	
77.81.609-DA	AlphaRail wiring rail	WAUKESHA®	VG F36	2	
77.81.809-DA	AlphaRail wiring rail	WAUKESHA®	VG F48	2	
77.81.614-DA	AlphaRail wiring rail	WAUKESHA®	VHP F2895GL/GSI	1	
77.81.614-DA	AlphaRail wiring rail	WAUKESHA®	VHP F3521GSI	1	
77.81.614-DA	AlphaRail wiring rail	WAUKESHA®	VHP L5790GSI	2	
77.81.614-DA	AlphaRail wiring rail	WAUKESHA®	VHP L7042G/GL/GU/GSI	2	
77.81.614-DA	AlphaRail wiring rail	WAUKESHA®	VHP L7044GL/GSI	2	
77.81.814-DF	AlphaRail wiring rail	WAUKESHA®	VHP P9390GL/GSI	2	
77.81.815-DA	AlphaRail wiring rail	WAUKESHA®	8L-AT27GL	1	
77.81.618-DA	AlphaRail wiring rail	WAUKESHA®	12V-AT27GL	2	
77.81.818-DA	AlphaRail wiring rail	WAUKESHA®	16V-AT27GL	2	
77.81.814-DA	AlphaRail wiring rail	WHITE SUPERIOR®	2408G	1	
77.81.613-DA	AlphaRail wiring rail	WHITE SUPERIOR®	6G/GT/GTL825	1	
77.81.813-DA	AlphaRail wiring rail	WHITE SUPERIOR®	8G/GTL825	1	
77.81.616-DA	AlphaRail wiring rail	WHITE SUPERIOR®	12GTLA825	2	
77.81.616-DA	AlphaRail wiring rail	WHITE SUPERIOR®	12SGT	2	
77.81.816-DA	AlphaRail wiring rail	WHITE SUPERIOR®	16GT/GTLB825	2	
77.81.816-DA	AlphaRail wiring rail	WHITE SUPERIOR®	16SGT	2	
77.81.531-DA	AlphaRail wiring rail	WORTHINGTON®	UTC-10	2	

<sup>1)</sup> NOTE: Applications may vary due to different variants or attachments, which could affect the installation of mentioned wiring rails. Consult factory for details and final confirmation.

## 2 Bracket Configuration

P/N <sup>1)</sup>	Figure	Description
75.10.303	2A	Bracket, 40x40 mm (Standard)
75.10.097	2B	Flat bar, 180° (Standard)
75.10.120	2C	Flat bar, 150°
75.10.280	2D	Flat bar, 90°

<sup>1)</sup> For packs of ten please add suffix "-10" to part number (e.g. 75.10.303-10).

## 3 Leads to connect Wiring Rail and Detonation Sensor (1 per Sensor required)

P/N	Figure	Description	Sensor Connector	Wiring Rail Connector	Length <sup>1)</sup>
43.30.016-L	3	Detonation sensor lead	2 pole, socket, 180°	MIL, 3 pole, socket, 180°	L=10/20/25/30/40/60 in

<sup>1)</sup> Other lengths available on request.

## 4 Detonation Sensor (1 per Cylinder required)

P/N	Figure	Description
43.20.001	4	Detonation sensor w/o lead, 2 pole

## 5 Harnesses to connect Wiring Rail and DetCon Control Unit (1 per Rail required)

P/N	Figure	Description	Wiring Rail Connector	Length
77.41.117-L	5A	Harness	MIL, 17 pole, socket, 180°	L=5/15/25/50 ft
77.41.317-L	5B	Harness	MIL, 17 pole, socket, 90°	L=5/15/25/50 ft

## 6 Accessories

P/N	Figure	Description
15.07.134	6A	Flex conduit, 3/4 in, black <sup>1)</sup>
15.07.231	6B	Fitting, 3/4 in, junction box to flex conduit
06.05.075	6C	Junction box

<sup>1)</sup> Flex conduit needs to be ordered in m/ft in required length.



# Gas Engine Control Systems

## TempScan20 MOTORTECH TEMPERATURE MODULE

### TempScan20 – MOTORTECH Temperature Module with 20 Channels

The TempScan20 temperature module monitors up to 20 thermocouples and provides the temperature information to the PowerView3 HMI module via CANopen.

#### Features

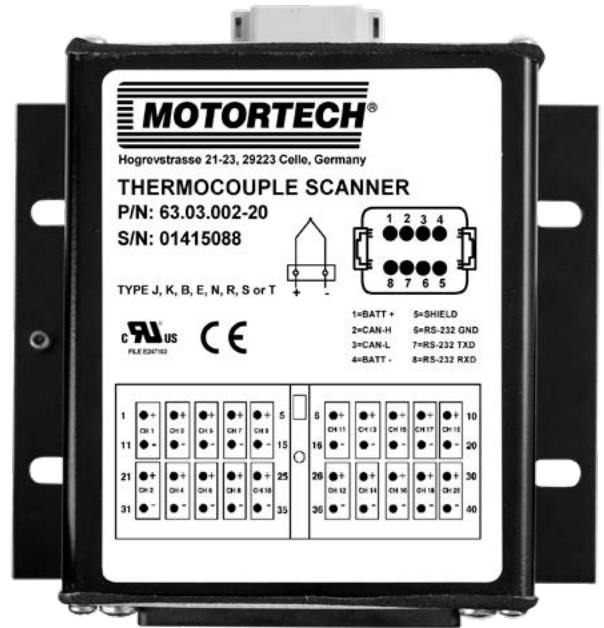

- Channels are independently configurable as Type B, E, J, K, N, R, S or T thermocouples
- Temperature information can include
  - Exhaust temperature
  - Winding temperature
  - Fluid temperature
- No additional programming or configuration required
- Integral diagnostics determine thermocouple integrity
- All channels are fully isolated from the CAN line and from the power supply.
- The temperature module features rugged packaging and watertight connectors for an IP67 rating.

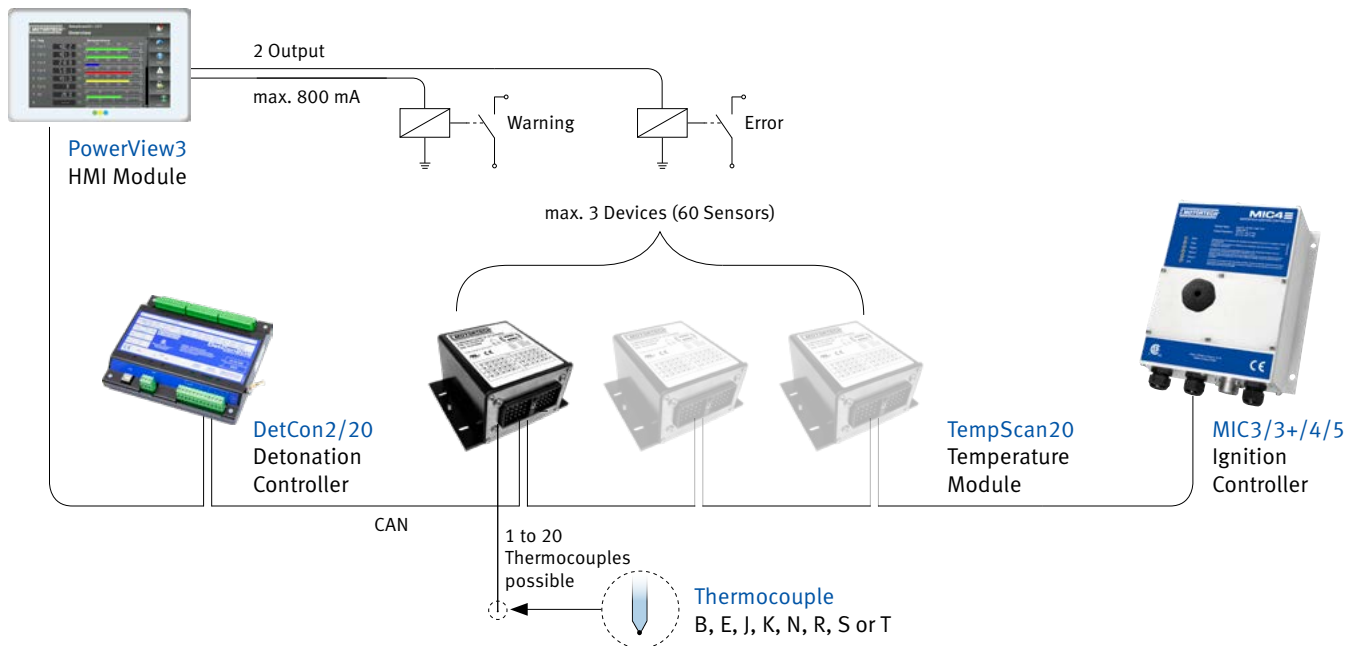

1



### Ordering Information

P/N	Figure	Description
63.03.002-20		TempScan20 temperature module, including connector package for power supply, CAN Bus and thermocouple wiring, operating manual
63.03.012-20		TempScan20 temperature module, built into stainless steel enclosure, including connector package for power supply, CAN Bus and thermocouple wiring, operating manual



2

## PowerView3 MOTORTECH ENGINE INFORMATION MONITOR

### Temperature Module Visualization

The operating data of the TempScan20 temperature module will be completely visualized via HMI module (Human Machine Interface). The overview screen shows the relevant information as combustion chamber temperature individually by cylinder or status of programmed temperature thresholds (Low – Normal – High – Switching Digital Output).

The control keys guarantee simple navigation through different display pages and menus. All in all the PowerView3 HMI module is also able to provide error diagnostics on-site without requiring a laptop!



1

The PowerView3 is also available for data visualization of:

- MIC Ignition Control (MIC3/3+, MIC4 and MIC5 series)
- DetCon Detonation Control

### Sample Screens

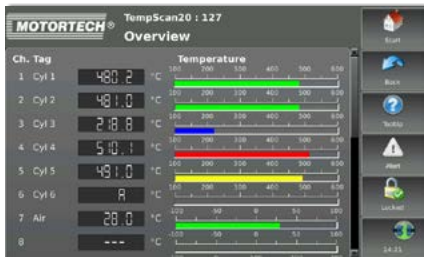

#### Overview

Screen shows the currently measured temperatures individually for each programmed channel/cylinder. Different colored gauges inform about programmed temperature thresholds (Low – Normal – High – Switching Digital Output).



#### Channel Settings

Channels can be configured individually and include options like user defined channel names, thermocouple type and temperature thresholds.

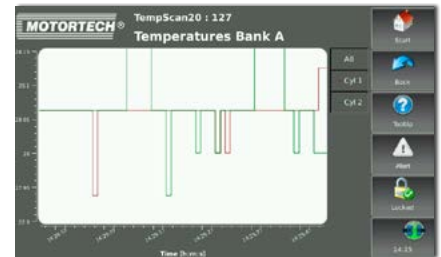

#### Trending Cylinder Temperatures

Visualization of temperature trend data for each individual cylinder.

### PowerView3 HMI Modules & Activation Codes



P/N	Figure	Description
06.05.085	1	PowerView3 HMI module
06.05.185	2	PowerView3 HMI module, built into stainless steel enclosure
06.05.187	3	PowerView3 HMI module, built into steel enclosure with sight window
06.05.088-F		PowerView3 activation code for visualization of TempScan data – Activation code has to be ordered separately with each PowerView3 HMI module
06.05.088-U		PowerView3 activation code for visualization of TempScan data – Only available for upgrade of existing PowerView3 HMI module in the field





# Gas Engine Control Systems



## Wiring Rail System for Temperature Control

The stainless steel wiring rails which are water tight due to a well approved foaming process, offer an easy and fast installation of accessory control systems such as

- Temperature control
- Gas valve systems

With individual outlet port connectors, the sensors can be individually connected and easily wired to the rail. A disconnectable main harness routs all sensors to one main control unit or individual wiring boxes.

### Details on the Thermocouple Wiring Rail:

- Up to 10 thermocouple inputs per rail
- As standard each rail comes with 2 additional thermocouple inputs for temperature measurement pre and post turbocharger
- All thermocouples need to be Type K (NiCrNi)
- Made of stainless steel which performs better than aluminum in harsh environments (and where operators use any kind of equipment to hold or stand on)
- Made to perfectly fit the application
- Rigid military style connectors are securely fastened into the stainless steel
- Rails are filled with special foam to ensure that all wires are separated from ground and will not vibrate and eventually short out to ground
- Water proof design – built to last in uncovered environment
- Repairable by MOTORTECH's assigned distributors in the event of mechanical damage

### General Details:

- Low voltage signals can be grouped in one rail. It is not recommended to have low and high voltage signals in one rail. In this case, detonation sensor and thermocouple leads match perfectly.
- Ignition and gas valve control wire work together well.

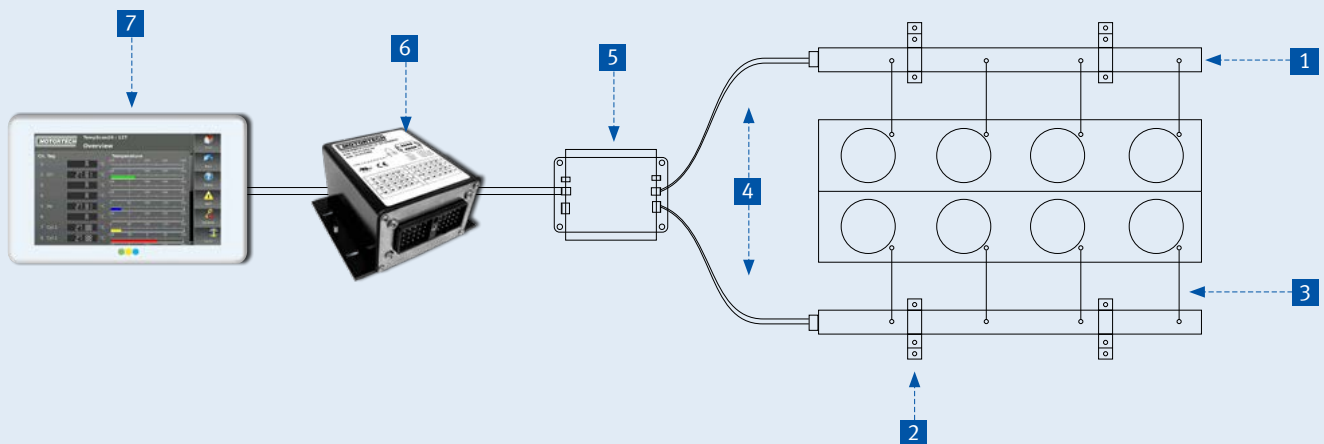
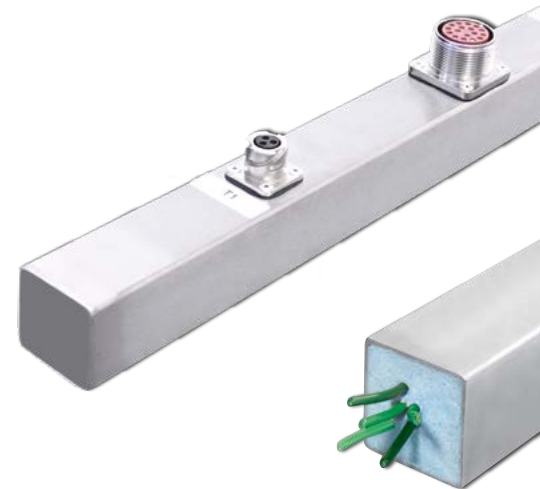

## 1 AlphaRail for Temperature Control – Specification Table

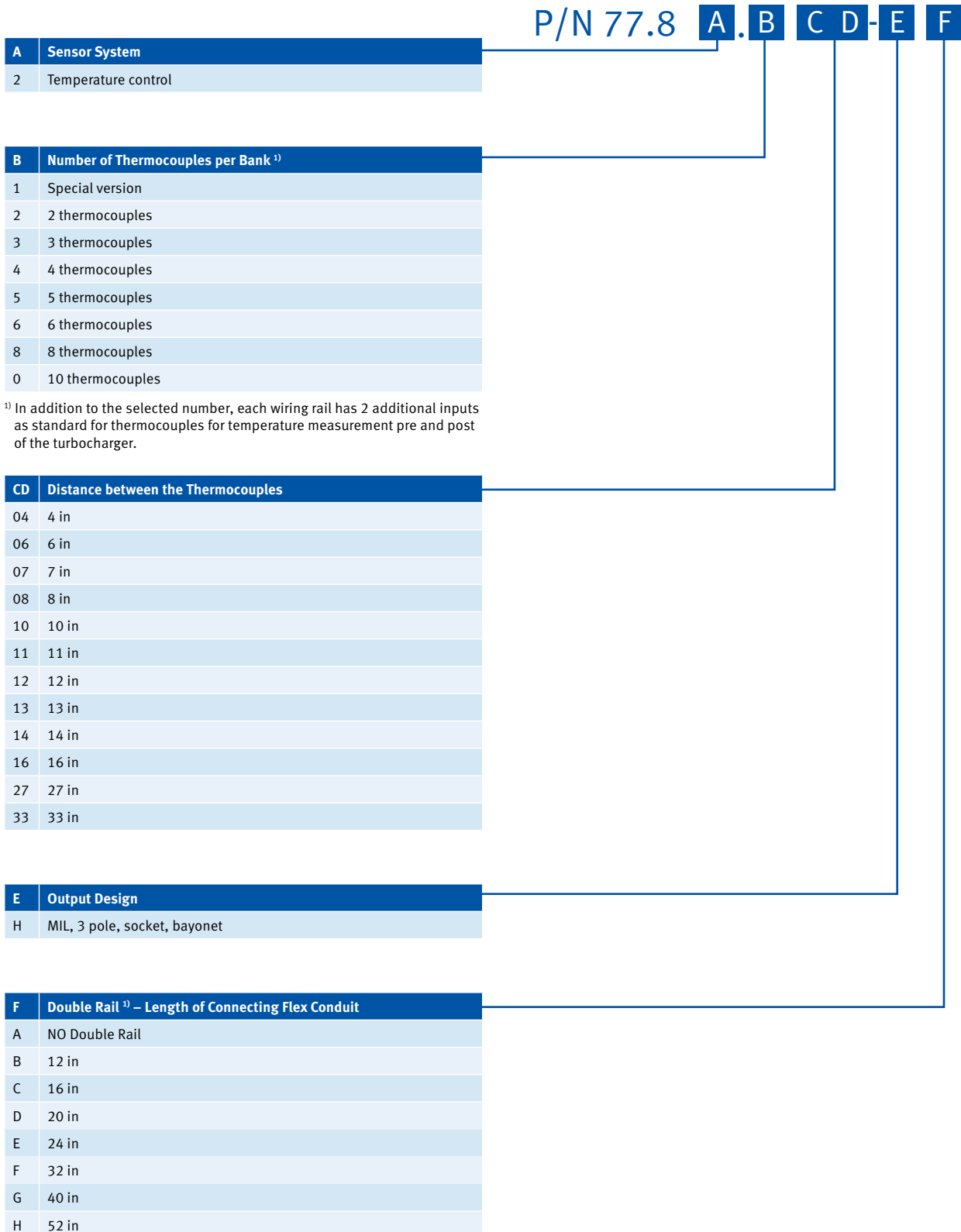

<sup>1)</sup> Two wiring rails connected by flex conduit.

Conversion: 1 inch = 25.4 mm / 1 foot = 0.3 m

# Gas Engine Control Systems

## 1 AlphaRail for Temperature Control – Wiring Rails for common Applications <sup>1)</sup>

P/N	Description	Engine Make	Model	Required Quantity per Engine	Equivalent to
77.82.406-HA	AlphaRail wiring rail	CATERPILLAR®	G3304	1	
77.82.606-HA	AlphaRail wiring rail	CATERPILLAR®	G3306	1	
77.82.607-HA	AlphaRail wiring rail	CATERPILLAR®	G3406	1	
77.82.407-HA	AlphaRail wiring rail	CATERPILLAR®	G3408	2	
77.82.607-HA	AlphaRail wiring rail	CATERPILLAR®	G3412	2	
77.82.411-HA	AlphaRail wiring rail	CATERPILLAR®	G3508	2	
77.82.611-HA	AlphaRail wiring rail	CATERPILLAR®	G3512	2	
77.82.811-HA	AlphaRail wiring rail	CATERPILLAR®	G3516	2	
77.82.631-HG	AlphaRail wiring rail	CLARK®	HBA-6T	1	
77.82.531-HA	AlphaRail wiring rail	CLARK®	HBA-10T	2	
77.82.637-HA	AlphaRail wiring rail	CLARK®	TCVD-12	2	
77.82.631-HG	AlphaRail wiring rail	CLARK®	TLA-6T	1	
77.82.544-HG	AlphaRail wiring rail	COOPER®	GMVH-10	2	
77.82.541-HG	AlphaRail wiring rail	COOPER®	GMW-10	2	
77.82.340-HA	AlphaRail wiring rail	COOPER®	GMWC-6	2	
77.82.822-HG	AlphaRail wiring rail	COOPER®	LSV-16	2	
77.82.633-HF	AlphaRail wiring rail	INGERSOLL RAND®	KVR-412	2	
77.82.344-HA	AlphaRail wiring rail	INGERSOLL RAND®	KVS-6	2	
77.82.427-HD	AlphaRail wiring rail	INGERSOLL RAND®	PKVG-8	2	
77.82.627-HD	AlphaRail wiring rail	INGERSOLL RAND®	PKVG-12	2	
77.82.627-HF	AlphaRail wiring rail	INGERSOLL RAND®	PKVGR-12	2	
77.82.437-HA	AlphaRail wiring rail	INGERSOLL RAND®	XVG-8	2	
77.82.606-HA	AlphaRail wiring rail	WAUKESHA®	F817	1	
77.82.614-HA	AlphaRail wiring rail	WAUKESHA®	F1197GL/GU	1	
77.82.608-HA	AlphaRail wiring rail	WAUKESHA®	VG F18	1	
77.82.808-HA	AlphaRail wiring rail	WAUKESHA®	VG F H24	1	
77.82.609-HA	AlphaRail wiring rail	WAUKESHA®	VG F L36	2	
77.82.809-HA	AlphaRail wiring rail	WAUKESHA®	VG F P48	2	
77.82.614-HA	AlphaRail wiring rail	WAUKESHA®	VHP F2895GL/GSI	1	
77.82.614-HA	AlphaRail wiring rail	WAUKESHA®	VHP F3521GSI	1	
77.82.614-HA	AlphaRail wiring rail	WAUKESHA®	VHP L5790GSI	2	
77.82.614-HA	AlphaRail wiring rail	WAUKESHA®	VHP L7042G/GL/GU/GSI	2	
77.82.614-HA	AlphaRail wiring rail	WAUKESHA®	VHP L7044GL/GSI	2	
77.82.814-HF	AlphaRail wiring rail	WAUKESHA®	VHP P9390GL/GSI	2	
77.82.815-HA	AlphaRail wiring rail	WAUKESHA®	8L-AT27GL	1	
77.82.618-HA	AlphaRail wiring rail	WAUKESHA®	12V-AT27GL	2	
77.82.818-HA	AlphaRail wiring rail	WAUKESHA®	16V-AT27GL	2	
77.82.814-HA	AlphaRail wiring rail	WHITE SUPERIOR®	2408G	1	
77.82.613-HA	AlphaRail wiring rail	WHITE SUPERIOR®	6G/GT/GTL825	1	
77.82.813-HA	AlphaRail wiring rail	WHITE SUPERIOR®	8G/GTL825	1	
77.82.616-HA	AlphaRail wiring rail	WHITE SUPERIOR®	12GTLA825	2	
77.82.616-HA	AlphaRail wiring rail	WHITE SUPERIOR®	12SGT	2	
77.82.816-HA	AlphaRail wiring rail	WHITE SUPERIOR®	16GT/GTLB825	2	
77.82.816-HA	AlphaRail wiring rail	WHITE SUPERIOR®	16SGT	2	
77.82.531-HA	AlphaRail wiring rail	WORTHINGTON®	UTC-10	2	

<sup>1)</sup> NOTE: Applications may vary due to different variants or attachments, which could affect the installation of mentioned wiring rails. Consult factory for details and final confirmation.

## AlphaRail Specification Table

### AlphaRail - Configuration Help

**In-Line Engine - One Rail**  
AlphaRail - Configuration Help

**In-Line Engine - One Double Rail**  
AlphaRail - Configuration Help

**In-Line Engine - Two Rails**  
AlphaRail - Configuration Help

### AlphaRail - Configuration Help

**V-Engine - Two Rails**  
AlphaRail - Configuration Help

**V-Engine - Two Double Rails**  
AlphaRail - Configuration Help

**V-Engine - Four Rails**  
AlphaRail - Configuration Help

Specification Table C - Rev. 04/09

### AlphaRail - Specification Table

**P/N 77-8A.B CD-E F**

**A = Sensor System**

- 1 = Detonation Sensor

**B = Specify Number of Sensors per Bank**

- 1 = Special Version
- 2 = 3 Sensors
- 3 = 4 Sensors
- 4 = 5 Sensors
- 5 = 6 Sensors
- 6 = 8 Sensors

**CD = Distance between the Sensors**

44	= 4" (102 mm)
46	= 6" (152 mm)
47	= 7" (178 mm)
48	= 8" (203 mm)
49	= 9" (229 mm)
51	= 11" (279 mm)
52	= 12" (305 mm)
53	= 14" (355 mm)
54	= 16" (406 mm)
55	= 18" (457 mm)
57	= 20" (508 mm)
58	= 22" (559 mm)

NOTE: Other odd length sizes are factory.

**P/N 77-8A**

### AlphaRail - Specification Help

Engine Make / Model \_\_\_\_\_ No. of Cylinders \_\_\_\_\_

**A) Sensor System**  
AlphaRail - Specification Help

Detonation Sensor

**B) Specify Number of Sensors per Bank**  
If the distance between the first and last cylinder exceeds 14" (355 mm) or more than 8 sensors per bank are needed, two separate sensor rails may be specified. For example see Configuration I.  
AlphaRail - Specification Help

Configuration I

Specify Sensor Rail A:  Special Version,  3 Sensors,  4 Sensors,  5 Sensors

Specify Sensor Rail B:  3 Sensors,  4 Sensors,  5 Sensors

**CD) Distance between the Sensors**  
AlphaRail - Specification Help

<input type="checkbox"/> 4" (102 mm)	<input type="checkbox"/> 12" (305 mm)
<input type="checkbox"/> 6" (152 mm)	<input type="checkbox"/> 13" (330 mm)
<input type="checkbox"/> 7" (178 mm)	<input type="checkbox"/> 14" (355 mm)
<input type="checkbox"/> 8" (203 mm)	<input type="checkbox"/> 16" (406 mm)
<input type="checkbox"/> 9" (229 mm)	<input type="checkbox"/> 18" (457 mm)
<input type="checkbox"/> 11" (279 mm)	<input type="checkbox"/> 20" (508 mm)
<input type="checkbox"/> 12" (305 mm)	<input type="checkbox"/> 22" (559 mm)
<input type="checkbox"/> 14" (355 mm)	<input type="checkbox"/> 24" (610 mm)
<input type="checkbox"/> 16" (406 mm)	<input type="checkbox"/> 26" (660 mm)
<input type="checkbox"/> 18" (457 mm)	<input type="checkbox"/> 28" (711 mm)

Other Length: \_\_\_\_\_

Specification Table C - Rev. 04/09

### AlphaRail - Harness & Sensor

**Detonation Control - Harness to connect Sensor Rail and DetConzo**  
AlphaRail - Harness

P/N	Length	Connector
77-44-107-5	5" (127 mm)	180"
77-44-107-10	10" (254 mm)	180"
77-44-107-15	15" (381 mm)	180"
77-44-107-20	20" (508 mm)	180"

**Detonation Control - Harness to connect Sensor Rail and DetConzo**  
AlphaRail - Harness

P/N	Length	Connector
77-44-107-5	5" (127 mm)	90"
77-44-107-10	10" (254 mm)	90"
77-44-107-15	15" (381 mm)	90"
77-44-107-20	20" (508 mm)	90"

**Detonation Control - Lead to connect Detonation Sensor and Sensor Rail**  
AlphaRail - Sensor Lead

P/N	Length	Sensor	Sensor Rail
43-39-408-04	10" (254 mm)	180"/0-pull	180"/0-pull
43-39-408-06	10" (254 mm)	180"/0-pull	180"/0-pull
43-39-408-08	10" (254 mm)	180"/0-pull	180"/0-pull
43-39-408-04	10" (254 mm)	180"/0-pull	180"/0-pull
43-39-408-06	10" (254 mm)	180"/0-pull	180"/0-pull

**Detonation Sensor**  
AlphaRail - Sensor

P/N	Description
43-39-081	Detonation Sensor w/0 lead - 180"/0-pull

### AlphaRail - Bracket Configuration & Accessories

**Bracket Configuration - Please order separately!**  
AlphaRail - Bracket Configuration

P/N: 75-10-097, 75-10-097, 75-10-104  
 NOTE: For packs of ten please add suffix -10 to part number.

**Accessories - Please order separately!**  
AlphaRail - Accessories

P/N: 15-40-130-4, 15-40-131-4  
 NOTE: 15-40-131-4 is "Adaptive Junction Box for Flex Conduit, 180"

Specification Table C - Rev. 04/09

# Gas Engine Control Systems

## 2 Bracket Configuration

P/N <sup>1)</sup>	Figure	Description
75.10.303	2A	Bracket, 40x40 mm (Standard)
75.10.097	2B	Flat bar, 180° (Standard)
75.10.120	2C	Flat bar, 150°
75.10.280	2D	Flat bar, 90°

<sup>1)</sup> For packs of ten please add suffix "-10" to part number (e.g. 75.10.303-10).

## 3 Thermocouples with Lead and Wiring Rail Connector – 90° (1 per Cylinder required)

P/N	Figure	Description	Wiring Rail Connector	Length
56.01.090-10	3A	Thermocouple, Type K (NiCrNi)	MIL, 3 pole, pin, 180°, bay.	10 in
56.01.090-20	3A	Thermocouple, Type K (NiCrNi)	MIL, 3 pole, pin, 180°, bay.	20 in
56.01.090-25	3A	Thermocouple, Type K (NiCrNi)	MIL, 3 pole, pin, 180°, bay.	25 in
56.01.090-30	3A	Thermocouple, Type K (NiCrNi)	MIL, 3 pole, pin, 180°, bay.	30 in
56.01.090-40	3A	Thermocouple, Type K (NiCrNi)	MIL, 3 pole, pin, 180°, bay.	40 in
56.01.090-60	3A	Thermocouple, Type K (NiCrNi)	MIL, 3 pole, pin, 180°, bay.	60 in
56.01.090-K <sup>1)</sup>	3A	Thermocouple, Type K (NiCrNi)	MIL, 3 pole, pin, 180°, bay.	177 in

<sup>1)</sup> Comes with loose connector and 177 in lead length.

## 3 Thermocouples with Lead and Wiring Rail Connector – 180° (1 per Cylinder required)

P/N	Figure	Description	Wiring Rail Connector	Length
56.01.180-10	3B	Thermocouple, Type K (NiCrNi)	MIL, 3 pole, pin, 180°, bay.	10 in
56.01.180-20	3B	Thermocouple, Type K (NiCrNi)	MIL, 3 pole, pin, 180°, bay.	20 in
56.01.180-25	3B	Thermocouple, Type K (NiCrNi)	MIL, 3 pole, pin, 180°, bay.	25 in
56.01.180-30	3B	Thermocouple, Type K (NiCrNi)	MIL, 3 pole, pin, 180°, bay.	30 in
56.01.180-40	3B	Thermocouple, Type K (NiCrNi)	MIL, 3 pole, pin, 180°, bay.	40 in
56.01.180-60	3B	Thermocouple, Type K (NiCrNi)	MIL, 3 pole, pin, 180°, bay.	60 in
56.01.180-K <sup>1)</sup>	3B	Thermocouple, Type K (NiCrNi)	MIL, 3 pole, pin, 180°, bay.	177 in

<sup>1)</sup> Comes with loose connector and 177 in lead length.

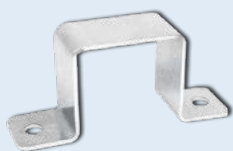

2A



2B



2C



2D

# Gas Engine Control Systems

## 4 Harness to connect Wiring Rails and TempScan Temperature Module For up to 6 Thermocouples + 2 Pre/Post Turbocharger (1 per Rail required)

P/N	Figure	Description	Wiring Rail Connector	Length
77.42.317-L	4	Harness for wiring rails	MIL, 17 pole, pin, 90°	L= 5/15/25/50 ft

## 4 Harness to connect Wiring Rails and TempScan Temperature Module For more than 6 Thermocouples + 2 Pre/Post Turbocharger (1 per Rail required)

P/N	Figure	Description	Wiring Rail Connector	Length
77.42.327-L	4	Harness for wiring rails	MIL, 17/10 pole, pin, 90°	L= 5/15/25/50 ft

## 5 Accessories

P/N	Figure	Description
06.05.076	5	Junction box
76.70.007		MIL connector, 3 pole, pin, 180°, bay., for connection of already installed thermocouples to AlphaRail wiring rail
28.10.014		Cable, 2x1.5 mm <sup>2</sup> , type K (NiCrNi) <sup>1)</sup>

<sup>1)</sup> Cable needs to be ordered in m/ft in required length.

## 6 TempScan20 Temperature Module

P/N	Figure	Description
63.03.002-20	6	TempScan20 temperature module, including connector package for power supply, CAN Bus and thermocouple wiring, operating manual
63.03.012-20		TempScan20 temperature module, built into stainless steel enclosure, including connector package for power supply, CAN Bus and thermocouple wiring, operating manual

## 7 PowerView3 HMI Modules & Activation Codes

P/N	Figure	Description
06.05.085	7	PowerView3 HMI module
06.05.185		PowerView3 HMI module, built into stainless steel enclosure
06.05.187		PowerView3 HMI module, built into steel enclosure with sight window
06.05.088-F		PowerView3 activation code for visualization of TempScan data – Activation code has to be ordered separately with each PowerView3 HMI module
06.05.088-U		PowerView3 activation code for visualization of TempScan data – Only available for upgrade of existing PowerView3 HMI module in the field



3A



3B



5



6



7



# Gas Engine Control Systems

## Throttle Bodies

Within a speed control system, a throttle body is used to regulate the supply of the gas/air mixture and thus the speed and power of a gas engine.

MOTORTECH throttle bodies have been specially developed for use on naturally aspirated and turbocharged gas engines and can be used for operation with a wide range of gas types (natural gas, biogas, sewage gas, mine gas, etc.). The standard throttle bodies, for connection to an external actuator, and ITB throttle bodies with integrated stepper motors meet the highest quality and performance requirements, enabling precise control of the gas engine and maintenance-free operation for a long period of time.



### General Features

- For use on naturally aspirated and turbocharged gas engines
- Use with various types of gas (natural gas, biogas, sewage gas, mine gas, etc.)
- The series 50, 100, 140 and 200 cover a wide range of applications
- Butterfly diameter from 1.65 to 4.92 inch (42 to 125 mm)
- Use of high-temperature ball bearings, designed for low-friction operation
- Additional sealing of the throttle body shaft for installation before and after the turbocharger
- Various variants available with and without O-rings embedded in the housing for flange sealing
- Butterfly and shaft made of stainless steel
- Rigid design for long service life
- Other sizes and custom made designs on request

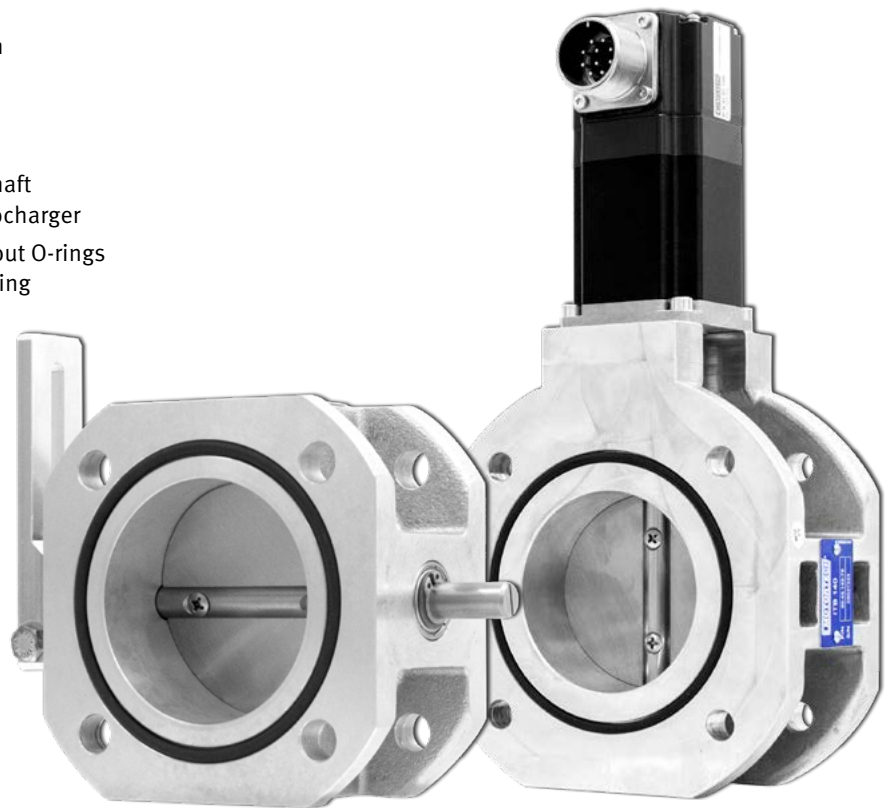

**Throttles**   
MOTORTECH THROTTLES/BUTTERFLY VALVES

**ITB**   
MOTORTECH INTEGRATED THROTTLE BODY

**NEW**

## Throttles

MOTORTECH THROTTLES/BUTTERFLY VALVES

### Throttle Bodies

MOTORTECH throttle bodies are equipped with a lever for connecting an external actuator. An end stop and a screw for idle speed adjustment provide additional adjustment options for optimum operation of stationary gas engines.

**Features:**

- End stop and screw for idle speed adjustment included
- Lever can be mounted on both sides of the shaft for flexible installation
- Mounting position of the throttle body is freely selectable
- Applicable for temperatures up to 392 °F (200 °C)

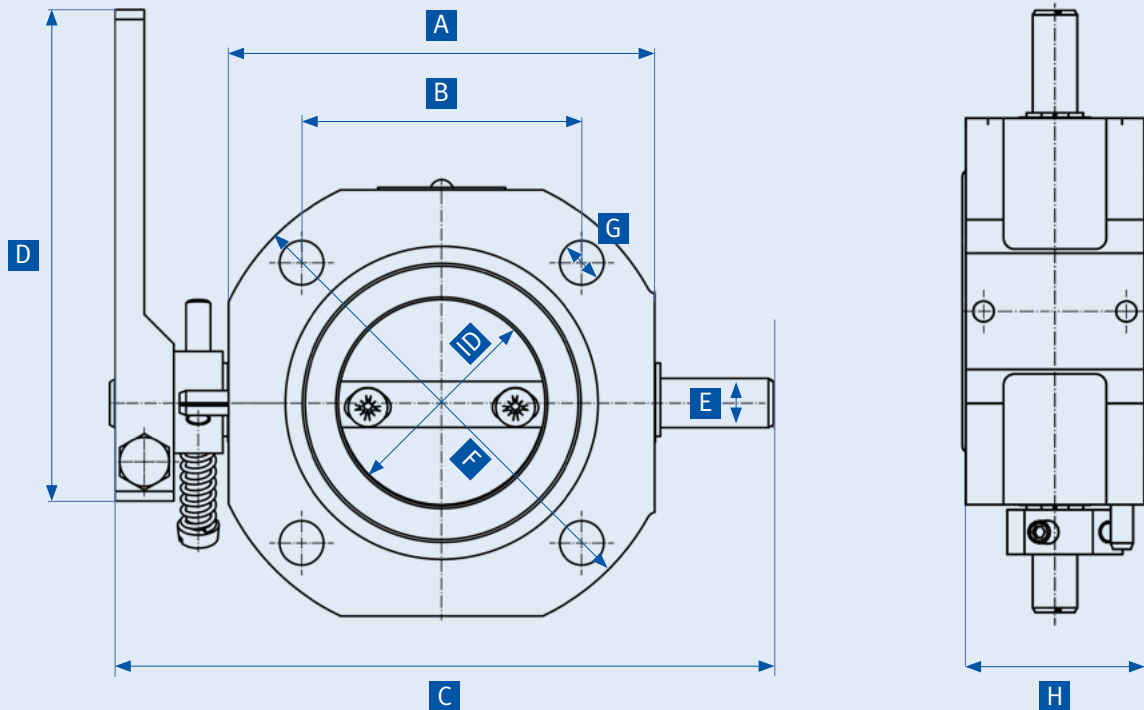
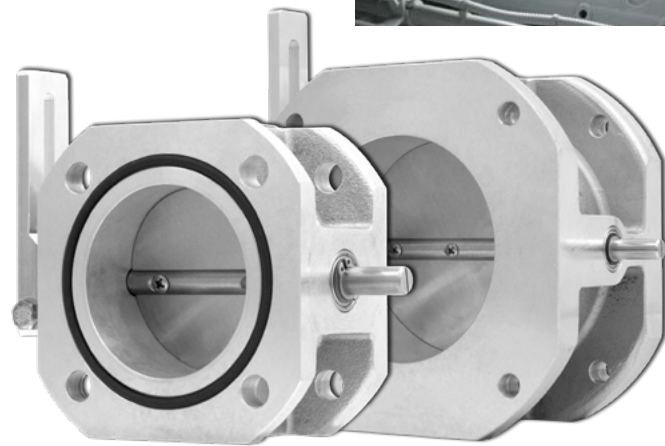

# Gas Engine Control Systems

## Standard – Series 50 (Inner Diameter 41 to 42 mm)

P/N	Supersedes	Description	ID	A	B	C	D	E	F	G	H	Equivalent to
30.41.050-42-HT	30.40.050-42, 30.40.051-42, 30.40.051-42-HT	Throttle body	42 mm	87 mm	57 mm	135 mm	100 mm	10 mm	96 mm	9 mm	40 mm	
30.41.055-42-HT <sup>1)</sup>	30.40.050-42, 30.40.051-42, 30.40.051-42-HT	Throttle body	42 mm	87 mm	57 mm	135 mm	100 mm	10 mm	96 mm	9 mm	40 mm	451-00-042-00, 51.13105-6020, 51.13105-6025

<sup>1)</sup> Throttle body without embedded O-ring for flange sealing.

## Standard – Series 100 (Inner Diameter 48 to 68 mm)

P/N	Supersedes	Description	ID	A	B	C	D	E	F	G	H	Equivalent to
30.41.100-60-HT	30.40.100-60, 30.40.101-60, 30.40.101-60-HT	Throttle body	60 mm	112 mm	75 mm	160 mm	100 mm	10 mm	125 mm	11 mm	61 mm	
30.41.105-60-HT <sup>1)</sup>	30.40.100-60, 30.40.101-60, 30.40.101-60-HT	Throttle body	60 mm	112 mm	75 mm	160 mm	100 mm	10 mm	125 mm	11 mm	61 mm	
30.41.100-68-HT	30.40.100-68, 30.40.101-68, 30.40.101-68-HT	Throttle body	68 mm	112 mm	75 mm	160 mm	100 mm	10 mm	125 mm	11 mm	61 mm	
30.41.105-68-HT <sup>1)</sup>	30.40.100-68, 30.40.101-68, 30.40.101-68-HT	Throttle body	68 mm	112 mm	75 mm	160 mm	100 mm	10 mm	125 mm	11 mm	61 mm	452-00-068-00, 51.13105-6007, 51.13105-6026

<sup>1)</sup> Throttle body without embedded O-ring for flange sealing.

## Standard – Series 140 (Inner Diameter 73 to 85 mm)

P/N	Supersedes	Description	ID	A	B	C	D	E	F	G	H	Equivalent to
30.41.140-75-HT	30.40.140-75, 30.40.141-75, 30.40.141-75-HT	Throttle body	75 mm	149 mm	95 mm	200 mm	150 mm	10 mm	166 mm	11 mm	76 mm	
30.41.145-75-HT <sup>1)</sup>	30.40.140-75, 30.40.141-75, 30.40.141-75-HT	Throttle body	75 mm	149 mm	95 mm	200 mm	150 mm	10 mm	166 mm	11 mm	76 mm	
30.41.140-80-HT	30.40.140-80, 30.40.141-80, 30.40.141-80-HT	Throttle body	80 mm	149 mm	95 mm	200 mm	150 mm	10 mm	166 mm	11 mm	76 mm	
30.41.145-80-HT <sup>1)</sup>	30.40.140-80, 30.40.141-80, 30.40.141-80-HT	Throttle body	80 mm	149 mm	95 mm	200 mm	150 mm	10 mm	166 mm	11 mm	76 mm	51.13105-6009, 51.13105-6027
30.41.140-85-HT	30.40.140-85, 30.40.141-85, 30.40.141-85-HT	Throttle body	85 mm	149 mm	95 mm	200 mm	150 mm	10 mm	166 mm	11 mm	76 mm	
30.41.145-85-HT <sup>1)</sup>	30.40.140-85, 30.40.141-85, 30.40.141-85-HT	Throttle body	85 mm	149 mm	95 mm	200 mm	150 mm	10 mm	166 mm	11 mm	76 mm	453-00-085-01

<sup>1)</sup> Throttle body without embedded O-ring for flange sealing.

## Standard – Series 150 (Inner Diameter 82 to 104 mm)

P/N	Supersedes	Description	ID	A	B	C	D	E	F	G	H	Equivalent to
30.41.150-90-HT	30.40.150-90, 30.40.151-90, 30.40.151-90-HT	Throttle body	90 mm	149 mm	110 mm	200 mm	150 mm	10 mm	194 mm	9 mm	80 mm	
30.41.155-90-HT <sup>1)</sup>	30.40.150-90, 30.40.151-90, 30.40.151-90-HT	Throttle body	90 mm	149 mm	110 mm	200 mm	150 mm	10 mm	194 mm	9 mm	80 mm	
30.41.150-100-HT	30.40.150-100, 30.40.151-100, 30.40.151-100-HT	Throttle body	100 mm	149 mm	110 mm	200 mm	150 mm	10 mm	194 mm	9 mm	80 mm	
30.41.155-100-HT <sup>1)</sup>	30.40.150-100, 30.40.151-100, 30.40.151-100-HT	Throttle body	100 mm	149 mm	110 mm	200 mm	150 mm	10 mm	194 mm	9 mm	80 mm	

<sup>1)</sup> Throttle body without embedded O-ring for flange sealing.

## Standard – Series 200 (Inner Diameter 98 to 125 mm)

P/N	Supersedes	Description	ID	A	B	C	D	E	F	G	H	Equivalent to
30.41.200-100-HT	30.40.200-100, 30.40.201-100, 30.40.201-100-HT	Throttle body	100 mm	179 mm	126 mm	230 mm	150 mm	10 mm	200 mm	11 mm	110 mm	51.13105-6018, 51.13105-6028
30.41.205-100-HT <sup>1)</sup>	30.40.200-100, 30.40.201-100, 30.40.201-100-HT	Throttle body	100 mm	179 mm	126 mm	230 mm	150 mm	10 mm	200 mm	11 mm	110 mm	
30.41.200-105-HT	30.40.200-105, 30.40.201-105, 30.40.201-105-HT	Throttle body	105 mm	179 mm	126 mm	230 mm	150 mm	10 mm	200 mm	11 mm	110 mm	
30.41.205-105-HT <sup>1)</sup>	30.40.200-105, 30.40.201-105, 30.40.201-105-HT	Throttle body	105 mm	179 mm	126 mm	230 mm	150 mm	10 mm	200 mm	11 mm	110 mm	
30.41.200-110-HT	30.40.200-110, 30.40.201-110, 30.40.201-110-HT	Throttle body	110 mm	179 mm	126 mm	230 mm	150 mm	10 mm	200 mm	11 mm	110 mm	
30.41.205-110-HT <sup>1)</sup>	30.40.200-110, 30.40.201-110, 30.40.201-110-HT	Throttle body	110 mm	179 mm	126 mm	230 mm	150 mm	10 mm	200 mm	11 mm	110 mm	
30.41.200-115-HT	30.40.200-115, 30.40.201-115, 30.40.201-115-HT	Throttle body	115 mm	179 mm	126 mm	230 mm	150 mm	10 mm	200 mm	11 mm	110 mm	
30.41.205-115-HT <sup>1)</sup>	30.40.200-115, 30.40.201-115, 30.40.201-115-HT	Throttle body	115 mm	179 mm	126 mm	230 mm	150 mm	10 mm	200 mm	11 mm	110 mm	454-00-115-00
30.41.200-120-HT	30.40.200-120, 30.40.201-120, 30.40.201-120-HT	Throttle body	120 mm	179 mm	126 mm	230 mm	150 mm	10 mm	200 mm	11 mm	110 mm	
30.41.205-120-HT <sup>1)</sup>	30.40.200-120, 30.40.201-120, 30.40.201-120-HT	Throttle body	120 mm	179 mm	126 mm	230 mm	150 mm	10 mm	200 mm	11 mm	110 mm	
30.41.200-125-HT	30.40.200-125, 30.40.201-125, 30.40.201-125-HT	Throttle body	125 mm	179 mm	126 mm	230 mm	150 mm	10 mm	200 mm	11 mm	110 mm	
30.41.205-120-HT <sup>1)</sup>	30.40.200-125, 30.40.201-125, 30.40.201-125-HT	Throttle body	125 mm	179 mm	126 mm	230 mm	150 mm	10 mm	200 mm	11 mm	110 mm	

<sup>1)</sup> Throttle body without embedded O-ring for flange sealing.

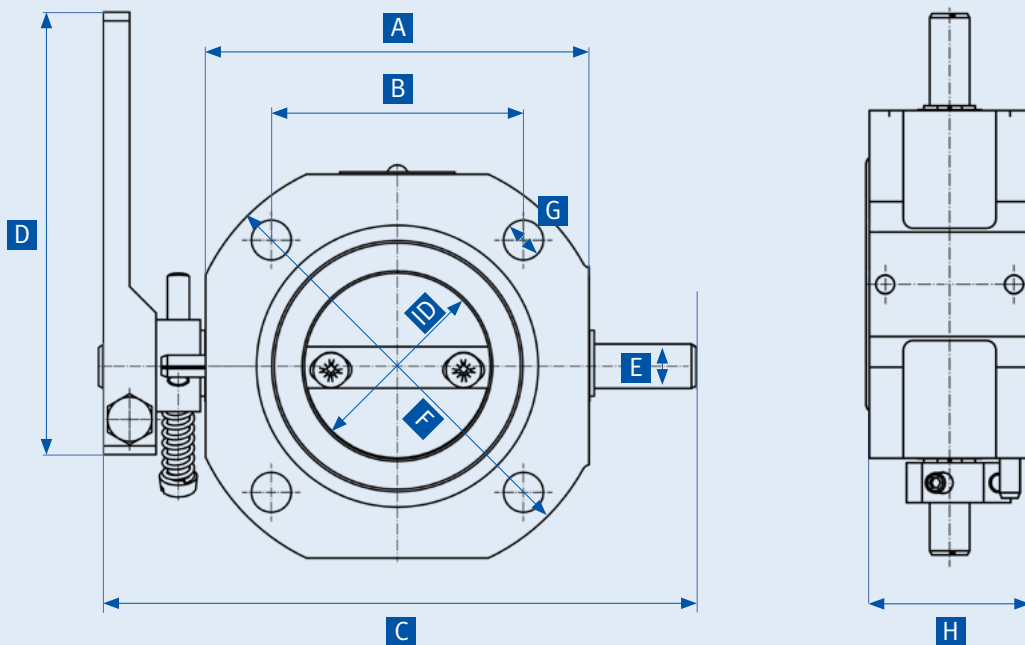

# Gas Engine Control Systems

NEW

## ITB

MOTORTECH INTEGRATED THROTTLE BODY



### Throttle Bodies with Integrated Stepper Motor

MOTORTECH ITB throttle bodies are equipped with an integrated stepper motor, which eliminates the use for an external actuator. The stepper motor is extremely precisely actuated by the VariStep3 stepper motor driver in combination with the SC100 speed controller.

#### Features:

- High-resolution stepper motors
- Precise adjustment due to microstep operation
- Short adjustment times for butterfly position
- Very precise control of the programmed positions without overshooting
- Mounting position of the throttle body is freely selectable
- Applicable for temperatures up to 257 °F (125 °C), High temperature types (-HT) up to 392 °F (200 °C)
- Precisely actuated by the VariStep3 stepper motor driver and SC100 speed controller

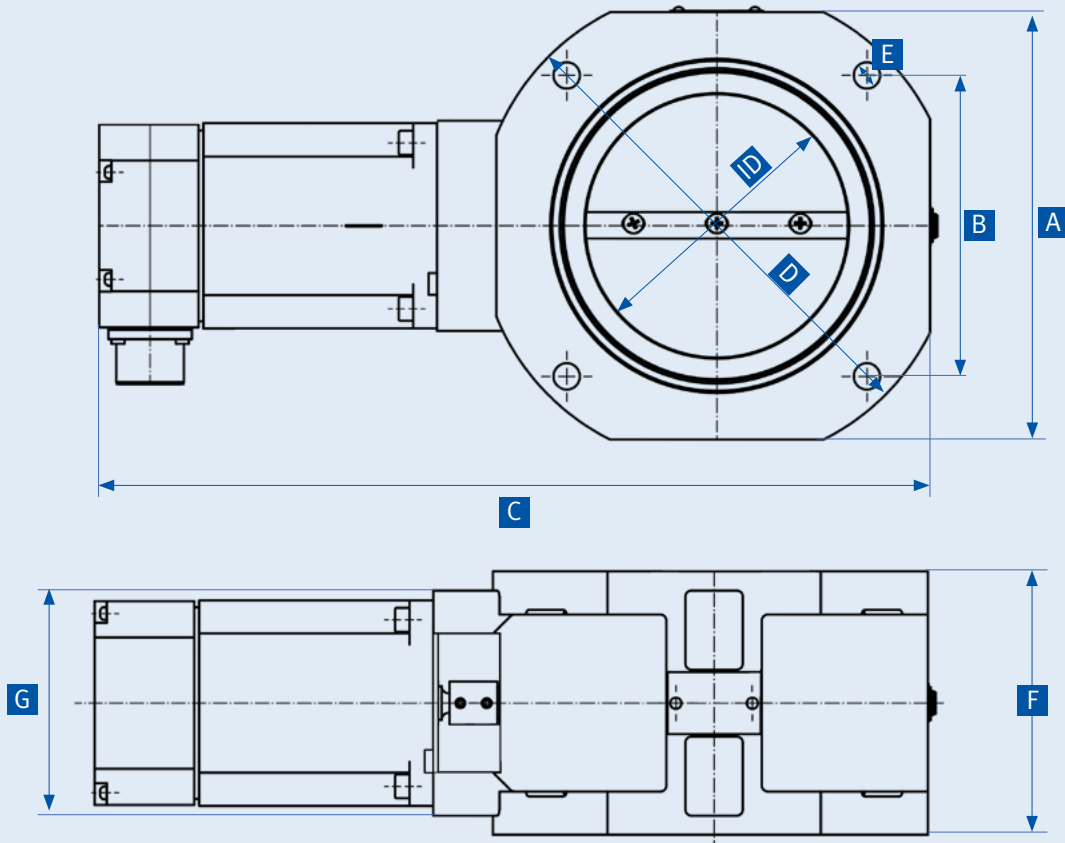

## System Overview

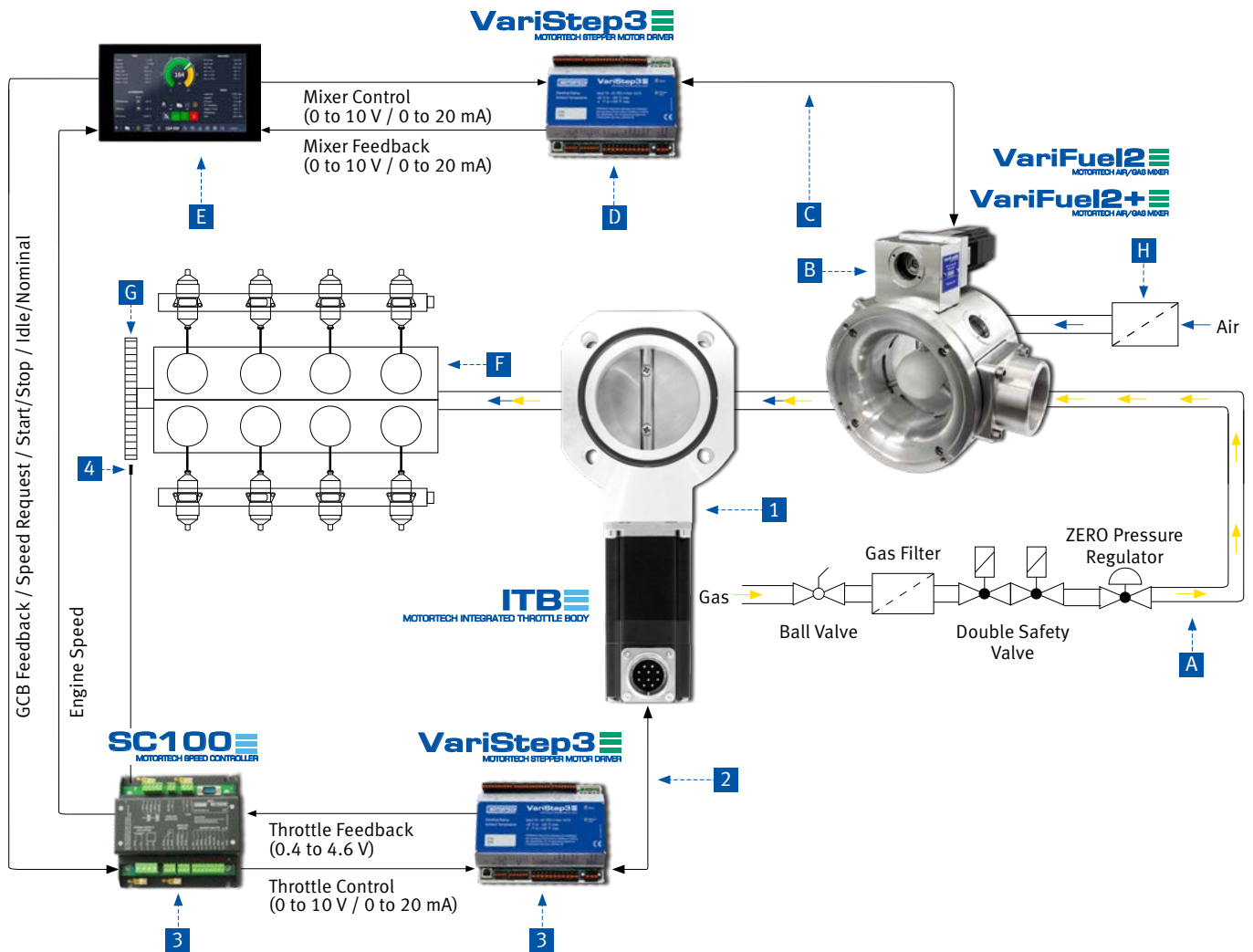

### Required Accessories

- 1 ITB throttle body with integrated stepper motor
- 2 Stepper motor harness
- 3 Speed control kit incl.
  - VariStep3 stepper motor driver
  - SC100 speed controller
- 4 Magnetic pickup

### Description

- A Gastrain
- B VariFuel2/VariFuel2+ air/gas mixer
- C Stepper motor harness
- D VariStep3 stepper motor driver
- E Master control
- F Engine
- G Flywheel
- B Air filter

# Gas Engine Control Systems

## 1 Standard – Series 50 (Inner Diameter 41 to 42 mm)

P/N <sup>1)</sup>	Supersedes	Description	A	B	C	D	E	F	G	Equivalent to
30.43.050-ID	30.42.050-ID	Integrated throttle body	87 mm	57 mm	233 mm	96 mm	9 mm	40 mm	58 mm	
30.43.055-ID <sup>2)</sup>	30.42.050-ID	Integrated throttle body	87 mm	57 mm	233 mm	96 mm	9 mm	40 mm	58 mm	
30.43.050-ID-HT	30.42.050-ID-HT	Integrated throttle body	87 mm	57 mm	248 mm	96 mm	9 mm	40 mm	58 mm	
30.43.055-ID-HT <sup>2)</sup>	30.42.050-ID-HT	Integrated throttle body	87 mm	57 mm	248 mm	96 mm	9 mm	40 mm	58 mm	

<sup>1)</sup> Standard inner diameters (-ID) = 42 mm; other inner diameters available on request.

<sup>2)</sup> Throttle body without embedded O-ring for flange sealing.

## 1 Standard – Series 100 (Inner Diameter 48 to 68 mm)

P/N <sup>1)</sup>	Supersedes	Description	A	B	C	D	E	F	G	Equivalent to
30.43.100-ID	30.42.100-ID	Integrated throttle body	112 mm	75 mm	258 mm	125 mm	11 mm	61 mm	61 mm	
30.43.105-ID <sup>2)</sup>	30.42.100-ID	Integrated throttle body	112 mm	75 mm	258 mm	125 mm	11 mm	61 mm	61 mm	
30.43.100-ID-HT	30.42.100-ID-HT	Integrated throttle body	112 mm	75 mm	273 mm	125 mm	11 mm	61 mm	61 mm	
30.43.105-ID-HT <sup>2)</sup>	30.42.100-ID-HT	Integrated throttle body	112 mm	75 mm	273 mm	125 mm	11 mm	61 mm	61 mm	

<sup>1)</sup> Standard inner diameters (-ID) = 60 mm, 68 mm; other inner diameters available on request.

<sup>2)</sup> Throttle body without embedded O-ring for flange sealing.

## 1 Standard – Series 140 (Inner Diameter 73 to 85 mm)

P/N <sup>1)</sup>	Supersedes	Description	A	B	C	D	E	F	G	Equivalent to
30.43.140-ID	30.42.140-ID	Integrated throttle body	149 mm	95 mm	295 mm	166 mm	11 mm	76 mm	76 mm	
30.43.145-ID <sup>2)</sup>	30.42.140-ID	Integrated throttle body	149 mm	95 mm	295 mm	166 mm	11 mm	76 mm	76 mm	
30.43.140-ID-HT	30.42.140-ID-HT	Integrated throttle body	149 mm	95 mm	310 mm	166 mm	11 mm	76 mm	76 mm	
30.43.145-ID-HT <sup>2)</sup>	30.42.140-ID-HT	Integrated throttle body	149 mm	95 mm	310 mm	166 mm	11 mm	76 mm	76 mm	

<sup>1)</sup> Standard inner diameters (-ID) = 75 mm, 80 mm, 85 mm; other inner diameters available on request.

<sup>2)</sup> Throttle body without embedded O-ring for flange sealing.

## 1 Standard – Series 150 (Inner Diameter 82 to 104 mm)

P/N <sup>1)</sup>	Supersedes	Description	A	B	C	D	E	F	G	Equivalent to
30.43.150-ID	30.42.150-ID	Integrated throttle body	149 mm	110 mm	323 mm	194 mm	9 mm	80 mm	86 mm	
30.43.155-ID <sup>2)</sup>	30.42.150-ID	Integrated throttle body	149 mm	110 mm	323 mm	194 mm	9 mm	80 mm	86 mm	
30.43.150-ID-HT	30.42.150-ID-HT	Integrated throttle body	149 mm	110 mm	348 mm	194 mm	9 mm	80 mm	86 mm	
30.43.155-ID-HT <sup>2)</sup>	30.42.150-ID-HT	Integrated throttle body	149 mm	110 mm	348 mm	194 mm	9 mm	80 mm	86 mm	

<sup>1)</sup> Standard inner diameters (-ID) = 90 mm, 100 mm; other inner diameters available on request.

<sup>2)</sup> Throttle body without embedded O-ring for flange sealing.

## 1 Standard – Series 200 (Inner Diameter 98 to 125 mm)

P/N <sup>1)</sup>	Supersedes	Description	A	B	C	D	E	F	G	Equivalent to
30.43.200-ID	30.42.200-ID	Integrated throttle body	179 mm	126 mm	352 mm	200 mm	11 mm	110 mm	88 mm	
30.43.205-ID <sup>2)</sup>	30.42.200-ID	Integrated throttle body	179 mm	126 mm	352 mm	200 mm	11 mm	110 mm	88 mm	
30.43.200-ID-HT	30.42.200-ID-HT	Integrated throttle body	179 mm	126 mm	377 mm	200 mm	11 mm	110 mm	88 mm	
30.43.205-ID-HT <sup>2)</sup>	30.42.200-ID-HT	Integrated throttle body	179 mm	126 mm	377 mm	200 mm	11 mm	110 mm	88 mm	

<sup>1)</sup> Standard inner diameters (-ID) = 100 mm, 105 mm, 110 mm, 115 mm, 120 mm, 125 mm; other inner diameters available on request.

<sup>2)</sup> Throttle body without embedded O-ring for flange sealing.

Conversion: 1 inch = 25.4 mm / 1 foot = 0.3 m



## 2 Stepper Motor Harnesses – Standard

P/N	Supersedes	Description	Connector	Length	Equivalent to
31.01.942		Stepper motor harness	MIL, 10 pole, socket , 90°	10 m (400 in)	
31.01.947-10		Stepper motor harness, with corrugated tube	MIL, 10 pole, socket , 90°	10 m (400 in)	
31.02.087-10		Stepper motor harness	MIL, 10 pole, socket , 90°	10 m (400 in)	31.01.942

## 2 Stepper Motor Harness – Special



P/N	Supersedes	Description	Connector	Length	Equivalent to
95.30.942-32 <sup>1)</sup>		Stepper motor harness, with fitting for 1/2 in flex conduit	MIL, 10 pole, socket , 90°	10 m (400 in)	

<sup>1)</sup> Flex conduit has to be ordered separately or supplied by customer.

### Accessories for Stepper Motor Harness – Special

P/N	Supersedes	Description	Equivalent to
15.07.112		Flex conduit, 1/2 in, black <sup>1)</sup>	
15.07.221		Fitting, 1/2 in, junction box to flex conduit	
06.05.075		Junction box	

<sup>1)</sup> Flex conduit needs to be ordered in m/ft in required length.

## 3 Speed Control Kit incl. VariStep3 Stepper Motor Driver and SC100 Speed Controller

P/N	Supersedes	Description	Equivalent to
63.04.002		Speed control kit incl. VariStep3 stepper motor driver and SC100 speed controller	

## 4 Magnetic Pickups for Speed Control

P/N	Supersedes	Description	Thread Size	Thread Length	Trigger	Equivalent to
63.60.001-50		Magnetic pickup with cable, 50 ft (15 m)	M16x1.5	3.125 in	holes, pins, teeth, screws	
63.60.002-50		Magnetic pickup with cable, 50 ft (15 m)	5/8-18 UNF	3.125 in	holes, pins, teeth, screws	



2



3



4

# Gas Engine Control Systems



MOTORTECH INTEGRATED THROTTLE BODY

## ITB Throttle Bodies and Throttle Body Drive Kits for MAN® Gas Engines

Most MAN® gas engines are already equipped at the factory with a throttle body for connection to an external actuator. MOTORTECH offers two possible alternatives for these applications with the ITB throttle bodies and throttle body drive kits for many engine types.

### ITB Throttle Bodies with Integrated Stepper Motor

MOTORTECH ITB throttle bodies are equipped with an integrated stepper motor, which eliminates the use for an external actuator. The stepper motor is extremely precisely actuated by the VariStep3 stepper motor driver in combination with the SC100 speed controller.

#### Features:

- High-resolution stepper motors
- Precise adjustment due to microstep operation
- Short adjustment times for butterfly position
- Very precise control of the programmed positions without overshooting
- Mounting position of the throttle body is freely selectable
- Applicable for temperatures up to 257 °F (125 °C), High temperature types (-HT) up to 392 °F (200 °C)
- Precisely actuated by the VariStep3 stepper motor driver and SC100 speed controller

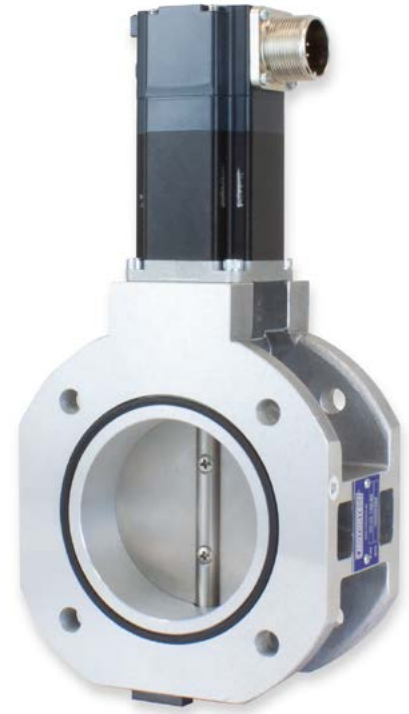
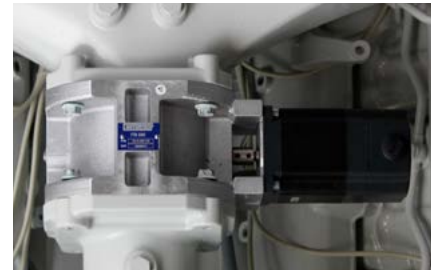

### Throttle Body Drive Kits

With the throttle body drive kits MOTORTECH offers for many MAN® gas engines a possibility of direct control of the factory installed throttle bodies. The stepper motor mounted on a suitable bracket is fastened directly on the throttle body and connected to the throttle body lever with a connecting rod and ball joints. The stepper motor is extremely precisely actuated by the VariStep3 stepper motor driver in combination with the SC100 speed controller.

#### Features:

- High-resolution stepper motor
- Precise adjustment due to microstep operation
- Short adjustment times for butterfly position
- Very precise control of the programmed positions without overshooting
- Engine-specific brackets with pre-mounted stepper motor
- Includes all attachment parts and stepper motor harness for easy installation



## ITB-Throttle Bodies and Drive Kits for MAN® Gas Engines

MAN® Engine		P/N ITB Throttle Body	P/N Throttle Body Drive Kit
Series	Type		
E0834	LE302	30.43.055-42	30.50.008
	LE312	30.43.055-42	
	LE322	30.43.055-42	
E0836	LE202	30.43.100-68	30.50.007
	LE302	30.43.100-68	
E2676	E302	30.43.200-100	30.50.009
	E312	30.43.200-100	
	LE202	30.43.145-80	
	LE212	30.43.145-80	
E2842	E302	30.43.152-100	30.50.012
	E312	30.43.152-100	
	LE202	30.43.145-80	
	LE302	30.43.152-100	
	LE312	30.43.152-100	
	LE322	30.43.145-80	
	LE332	30.43.145-80	
E2848	LE322		30.50.005
E2876	LE202	30.43.152-100	30.50.006
	LE212	30.43.152-100	30.50.006
	LE302	30.43.152-100	30.50.006
	TE302	30.43.100-68-HT	
E3268	LE212	30.43.200-100-HT	
	LE222	30.43.200-100-HT	
	LE232	30.43.200-100-HT	
	LE242	30.43.200-100-HT	
	LE252	30.43.200-100-HT	
	LE262	30.43.200-100-HT	
E3262	E302	30.43.200-100	
	LE202	30.43.200-100-HT	
	LE212	30.43.200-100-HT	
	LE232	30.43.200-100-HT	
	LE242	30.43.200-100-HT	

# Gas Engine Control Systems

## Throttle Bodies for MAN® E2876 LE 202/212/302, E2842 E312, E2842 LE312



Based on its proven design, MOTORTECH offers a special throttle body for MAN® engine series E2876 LE and E2842 E/LE. Engineered as a replacement and plug & play solution for the original part, the throttle body perfectly fits into the existing structure between both manifolds behind the intercooler of the engine.

In addition to the commonly used version, MOTORTECH completes the series with the ITB throttle body design. The integrated stepper motor is extremely precisely actuated by the VariStep3 stepper motor driver in combination with the SC100 speed controller and eliminates the use of an external actuator. This version is especially suited for new installations or plant and engine revisions.

For more information:



### Properties & Features

- Applicable for media such as natural gas and special gases
- Reinforced shaft and butterfly valve made of stainless
- High temperature resistant shaft seals
- Use of ball bearings instead of plain bearings
- End stop and screw for idle speed adjustment
- Lever for connection to the external actuator or integrated stepper motor
- Same flange design for a simple replacement
- O-rings for sealing embedded in the housing
- Maintenance-free part

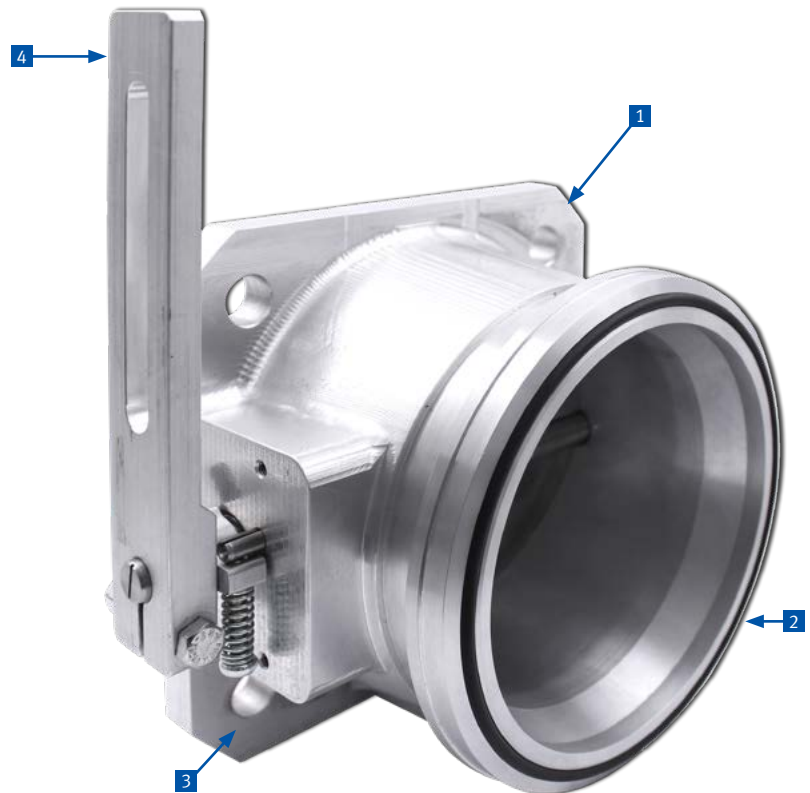

Flange opposite to intercooler



Flange intercooler-sided



End stop and screw for idle speed adjustment



Lever for connection to an external actuator

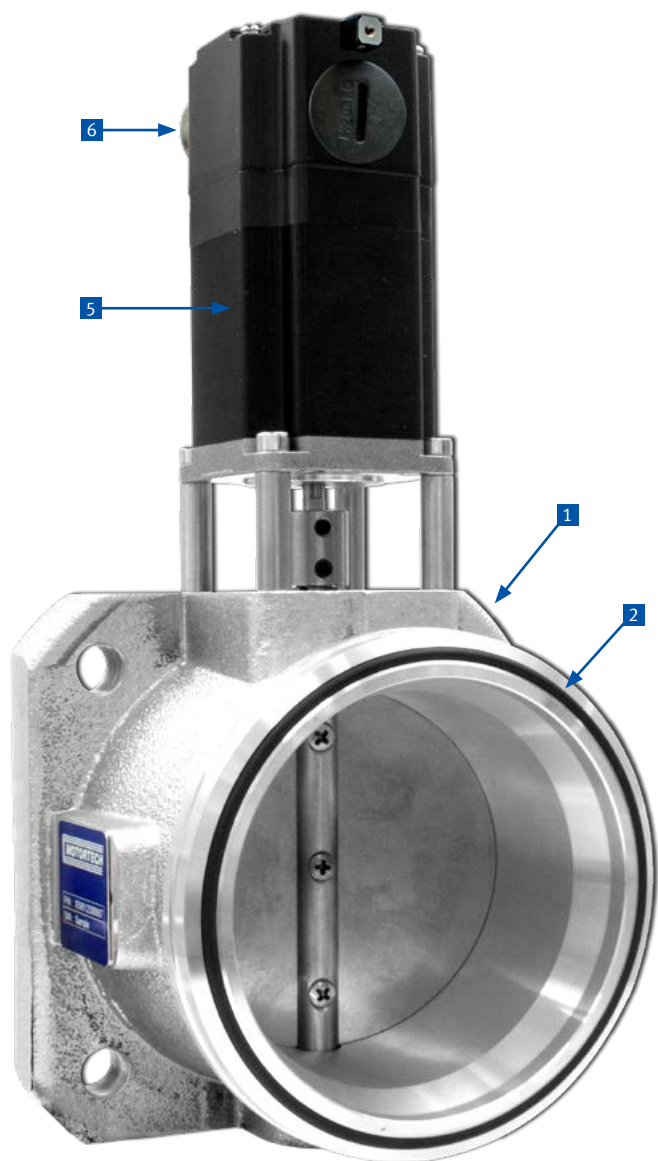

Integrated stepper motor



MIL connector for connection to VariStep3 stepper motor driver

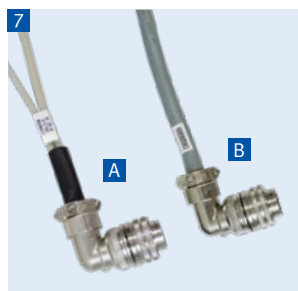

Stepper motor harness



VariStep3 stepper motor driver



SC100 speed controller



Pickup

## Throttle Body

P/N	Supersedes	Description	Equivalent to
30.41.152-100-HT		Throttle body for MAN® E2876 LE 2xx/302, E2842 E312, E2842 LE312	51.13105-6013, 51.13105-6021

## ITB Throttle Body & Accessories

P/N	Figure	Supersedes	Description	Equivalent to
30.43.152-100			ITB throttle body for MAN® E2876 LE 2xx/302, E2842 E312, E2842 LE312	30.41.152-100-HT
31.01.942	7A		Stepper motor harness, MIL, 10 pole, socket, 90°, length 400 in (10 m)	
31.02.087-10	7B		Stepper motor harness, MIL, 10 pole, socket, 90°, length 400 in (10 m)	31.01.942
63.04.002	8		Speed control kit incl. VariStep3 stepper motor driver and SC100 speed controller	
63.60.001-50	9		Pickup, magnetic, M16x1,5 x 3.125 in (79 mm), 50 ft (15 m) cable	
alternative 63.60.002-50	9		Pickup, magnetic, 5/8-18 UNF x 3.125 in (79 mm), 50 ft (15 m) cable	



# Gas Engine Control Systems

## Throttle Bodies for WAUKESHA® VHP G/ GSI/ LT Series 6 and 12 Cylinder Engines

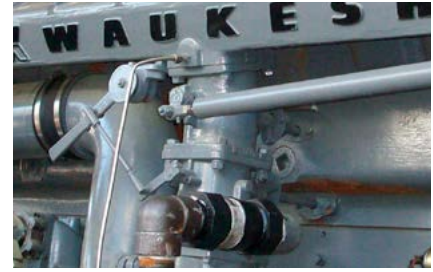

Based on its proven design, MOTORTECH offers a special throttle body series for WAUKESHA® VHP series in-line and V-engines. Designed as a replacement and plug-and-play solution, the throttle bodies perfectly fit the position of the original part below the intake manifold.

In addition and as an upgrade to the commonly used version, MOTORTECH completes the series with the ITB throttle body design. The integrated stepper motor is extremely precisely actuated by the VariStep3 stepper motor driver and eliminates the use of an external actuator. Both, ITB throttle body and VariStep3 stepper motor driver, operate with the standard WOODWARD® 2301D speed governor or with the SC100 speed controller.

### Properties & Features

- Same design and shape for easy replacement of original part
- Reinforced shaft and butterfly valve made of stainless steel for high durability even when backfiring has occurred
- Use of ball bearings instead of plain bearings
- Including end stop and idle speed adjustment
- Lever for connection to the external actuator or integrated high-resolution stepper motor (ITB)
- High temperature resistant shaft seals
- Applicable for media such as natural gas and special gases
- Maintenance free product

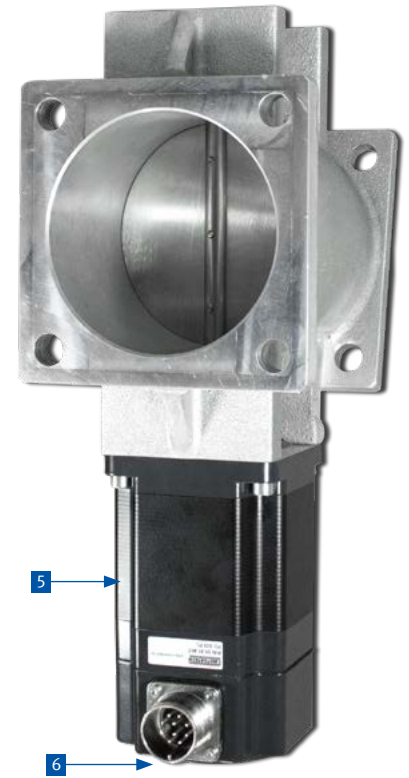
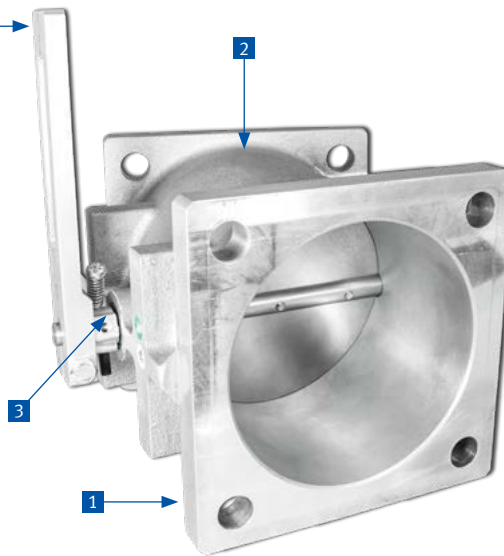

For more information:



Same flange sizes as original part



Identical design and shape for easy assembly



End stop with adjustment screw for idle speed



Lever for connection to the external actuator

# Gas Engine Control Systems



Integrated stepper motor



MIL style connector for connection to VariStep3 stepper motor driver



VariStep3 stepper motor driver



SC100 speed controller

## Throttle Bodies – WAUKESHA® VHP G/ GSI/ LT Series

P/N	Description	Equivalent to
30.41.151-106-VHP-6	Throttle body for WAUKESHA® VHP 6 cylinder in-line engines F2895G/GSI, F3521G/GSI	E204072
30.41.151-106-VHP-12	Throttle body for WAUKESHA® VHP 12 cylinder V-engines L5108G/GSI, L5790G/GSI, L5774LT, L5794GSI, L7042G/GSI, L7044GSI, fits left and right bank	E204072, A204072, E204072A, A204072A, F204072A

## ITB Throttle Bodies & Accessories – WAUKESHA® VHP G/ GSI/ LT Series

P/N	Description	Quantity	To replace
75.30.148-6	ITB throttle body conversion kit for WAUKESHA® VHP 6 cylinder in-line engines F2895G/GSI, F3521G/GSI  Contains: <ul style="list-style-type: none"> <li>■ ITB throttle body P/N 30.43.151-106-VHP-6</li> <li>■ Stepper motor harness P/N 31.01.942</li> <li>■ VariStep3 stepper motor driver P/N 31.01.960 <b>7</b></li> </ul>	<ul style="list-style-type: none"> <li>■ 1 pc</li> <li>■ 1 pc</li> <li>■ 1 pc</li> </ul>	<ul style="list-style-type: none"> <li>■ E204072</li> </ul>
<i>alternative</i> 75.30.149-6	ITB throttle body conversion kit for WAUKESHA® VHP 6 cylinder in-line engines F2895G/GSI, F3521G/GSI  Contains: <ul style="list-style-type: none"> <li>■ ITB throttle body P/N 30.43.151-106-VHP-6</li> <li>■ Stepper motor harness P/N 31.01.942</li> <li>■ VariStep3 stepper motor driver P/N 31.01.960 <b>7</b></li> </ul> Stepper motor driver built into stainless steel enclosure	<ul style="list-style-type: none"> <li>■ 1 pc</li> <li>■ 1 pc</li> <li>■ 1 pc</li> </ul>	<ul style="list-style-type: none"> <li>■ E204072</li> </ul>
75.30.148-12	ITB throttle body conversion kit for WAUKESHA® VHP 12 cylinder V-engines L5108G/GSI, L5790G/GSI, L5774LT, L5794GSI, L7042G/GSI, L7044GSI  Contains: <ul style="list-style-type: none"> <li>■ ITB throttle body P/N 30.43.151-106-VHP-12, fits left and right bank</li> <li>■ Stepper motor harness P/N 31.01.942</li> <li>■ VariStep3 stepper motor driver P/N 31.01.960 <b>7</b></li> <li>■ Isolation amplifier P/N 63.02.017</li> </ul>	<ul style="list-style-type: none"> <li>■ 2 pcs</li> <li>■ 2 pcs</li> <li>■ 2 pcs</li> <li>■ 1 pc</li> </ul>	<ul style="list-style-type: none"> <li>■ E204072, A204072, E204072A, A204072A, F204072A</li> </ul>
<i>alternative</i> 75.30.149-12	ITB throttle body conversion kit for WAUKESHA® VHP 12 cylinder V-engines L5108G/GSI, L5790G/GSI, L5774LT, L5794GSI, L7042G/GSI, L7044GSI  Contains: <ul style="list-style-type: none"> <li>■ ITB throttle body P/N 30.43.151-106-VHP-12, fits left and right bank</li> <li>■ Stepper motor harness P/N 31.01.942</li> <li>■ VariStep3 stepper motor driver P/N 31.01.960 <b>7</b></li> <li>■ Isolation amplifier P/N 63.02.017</li> </ul> Stepper motor drivers and isolation amplifier pre wired and built into stainless steel enclosure	<ul style="list-style-type: none"> <li>■ 2 pcs</li> <li>■ 2 pcs</li> <li>■ 2 pcs</li> <li>■ 1 pc</li> </ul>	<ul style="list-style-type: none"> <li>■ E204072, A204072, E204072A, A204072A, F204072A</li> </ul>
<i>optional</i> 63.50.114	SC100 speed controller to replace WOODWARD® 2301D speed governor <b>8</b>	<ul style="list-style-type: none"> <li>■ 1 pc per kit</li> </ul>	



# Gas Engine Control Systems

## Throttle Bodies for WAUKESHA® VHP GL/ GSID/ LT/ LTD Series 12 Cylinder Gas Engines

As an upgrade to the commonly used version, MOTORTECH offers the ITB throttle body design also for WAUKESHA® VHP GL/ GSID/ LT/ LTD series 12 cylinder V-engines. Based on its proven design, the throttle bodies perfectly fit the position of the original part below the intake manifold.

The integrated stepper motor is extremely precisely actuated by the VariStep3 stepper motor driver and eliminates the use of an external actuator. Both, ITB throttle body and VariStep3 stepper motor driver, operate with the standard WOODWARD® 2301D speed governor or with the SC100 speed controller.



### Properties & Features

- Design and shape allow easy replacement of the original part
- Reinforced shaft and butterfly valve made of stainless steel for high durability even when backfiring has occurred
- Use of ball bearings instead of plain bearings
- Integrated high-resolution stepper motor
- High temperature resistant shaft seals
- Applicable for media such as natural gas and special gases
- Maintenance free product

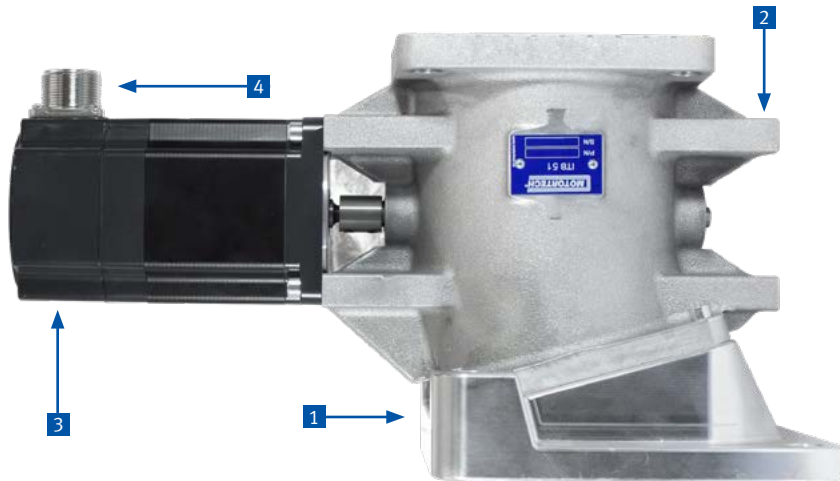

For more information:



Same flange sizes as original part



Design and shape allow easy assembly



Integrated stepper motor



MIL style connector for connection to VariStep3 stepper motor driver

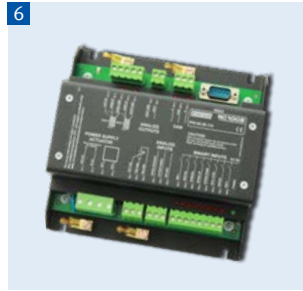

VariStep3 stepper motor driver    SC100 speed controller

## ITB Throttle Bodies & Accessories – WAUKESHA® VHP GL/GSID/LT/LTD Series

P/N	Description	Quantity	To replace
75.30.159-12	ITB throttle body conversion kit for WAUKESHA® VHP 12 cylinder V-engines L5774LTD, L5790GL, L5794GSID/LT/LTD, L7042GL, L7044GSID  Contains: <ul style="list-style-type: none"> <li>■ ITB throttle body P/N 30.43.153-106-VHP-R (right bank)</li> <li>■ ITB throttle body P/N 30.43.153-106-VHP-L (left bank)</li> <li>■ Stepper motor harness P/N 31.01.942</li> <li>■ VariStep3 stepper motor driver P/N 31.01.960 <b>5</b></li> <li>■ Isolation amplifier P/N 63.02.017</li> </ul>	<ul style="list-style-type: none"> <li>■ 1 pc</li> <li>■ 1 pc</li> <li>■ 2 pcs</li> <li>■ 2 pcs</li> <li>■ 1 pc</li> </ul>	<ul style="list-style-type: none"> <li>■ E257472D</li> <li>■ F257472D</li> </ul>
<i>alternative</i> 75.30.160-12	ITB throttle body conversion kit for WAUKESHA® VHP 12 cylinder V-engines L5774LTD, L5790GL, L5794GSID/LT/LTD, L7042GL, L7044GSID  Contains: <ul style="list-style-type: none"> <li>■ ITB throttle body P/N 30.43.153-106-VHP-R (right bank)</li> <li>■ ITB throttle body P/N 30.43.153-106-VHP-L (left bank)</li> <li>■ Stepper motor harness P/N 31.01.942</li> <li>■ VariStep3 stepper motor driver P/N 31.01.960 <b>5</b></li> <li>■ Isolation amplifier P/N 63.02.017</li> </ul> Stepper motor drivers and isolation amplifier pre wired and built into stainless steel enclosure	<ul style="list-style-type: none"> <li>■ 1 pc</li> <li>■ 1 pc</li> <li>■ 2 pcs</li> <li>■ 2 pcs</li> <li>■ 1 pc</li> </ul>	<ul style="list-style-type: none"> <li>■ E257472D</li> <li>■ F257472D</li> </ul>
<i>optional</i> 63.50.114	SC100 speed controller to replace WOODWARD® 2301D speed governor <b>6</b>	<ul style="list-style-type: none"> <li>■ 1 pc per kit</li> </ul>	

# Gas Engine Control Systems



## ALL-IN-ONE

For monitoring, controlling, regulating and system protection. ALL-IN-ONE is an expandable controller for both single and multiple gen-sets operating in standby or parallel modes, especially in cogeneration (CHP) and other complex applications.

Modular design (consisting of AIO controller and display unit) allows easy installation with the ability to add many different extension modules designed to suit individual customer requirements.

Integrated functions such as fully automatic synchronization or un-interruptible back-synchronisation in mains parallel operation as well as integrated solutions for multi-unit operation, load sharing or automatic operating hours adjustment of the individual units are standard features of the AIO generator & CHP control system. Up to 32 units can be combined in one group.

AIO supports many standard ECU (electronic control unit) types from which it can read relevant control data via Bus. A powerful graphic display with user-friendly controls allows any operator to find the information they need. The display on the basic version is capable of displaying graphical characters (e.g. Chinese).



AIO.Vision12 Display

AIO.GAS Controller

Ready for **VDE-AR-N 4110** and **VDE-AR-N-4105**

### Benefits

- Support of engines with ECU (electronic control unit)
- Individually configurable to match customer's needs exactly
- Complete integrated gen-set solution incorporating built-in PLC and signal sharing via CAN bus – minimum external components needed
- Many communication options – easy remote supervising and servicing
- Perfect price/performance ratio
- Gen-set performance log for easy problem tracing
- Air/Fuel Ratio function for lean burn gas engines (requires additional hardware dongle)
- Voltage and power factor control (AVR)
- Generator measurement: U, I, Hz, kW, kVAR, kVA, PF, kWh, kVAh
- Mains measurement: U, I, Hz, kW, kVAR, PF
- Selectable measurement ranges for AC voltages and currents – 120/277 V, 0-1/0-5 A
- Inputs and outputs configurable for various customer needs
- Controller redundancy
- 2x RS232/RS485 interface with Modbus protocol
- Support; Analog/GSM/ISDN/CDMA modem communication support; SMS messages; ECU Modbus interface; secondary RS485 converter is isolated

### Features

- CHP support (programmable PID control loops and other built-in PLC functions)
- Support of engines with ECU (J1939, Modbus and other proprietary interfaces); alarm codes displayed in text form
- Automatic synchronizing and power control (via speed governor or ECU)
- Baseload, Import/Export, TempByPower
- Peak shaving
- Event-based history (up to 1000 records) with customer-selectable list of stored values; RTC; statistic values
- Integrated PLC programmable functions
- Interface to remote display units (3x AIO.Vision-display)
- USB 2.0 slave interface
- Sealed to IP65

### Integrated fixed and configurable protections

- 3 phase integrated generator protections (U + f)
- IDMT overcurrent + shortcurrent protection
- Overload protection
- Reverse power protection
- Earth fault current protection
- 3 phase integrated mains protections (U + f)
- Vector shift protection
- All binary/analog inputs free configurable for various protection types
- Phase rotation and phase sequence protection
- Additional 160 programmable protections configurable for any measured value to create customer-specific protections
- Application security



Scan QR Code®

# Gas Engine Control Systems



### IntelliMains

- Import/export
- Load sharing
- Power management
- Grid monitoring
- Running hours optimization

### IntelliPro

- Designed to meet utility protection requirements
- Combines standard and optional features
- Advanced communications
- Data/event logging

or

### MainsPro

- Protective functions
- Free assignment of 5 relay outputs
- 4 binary switches to remotely change operation of the unit
- Last trip recorded in order to provide the evidence of cause of trip

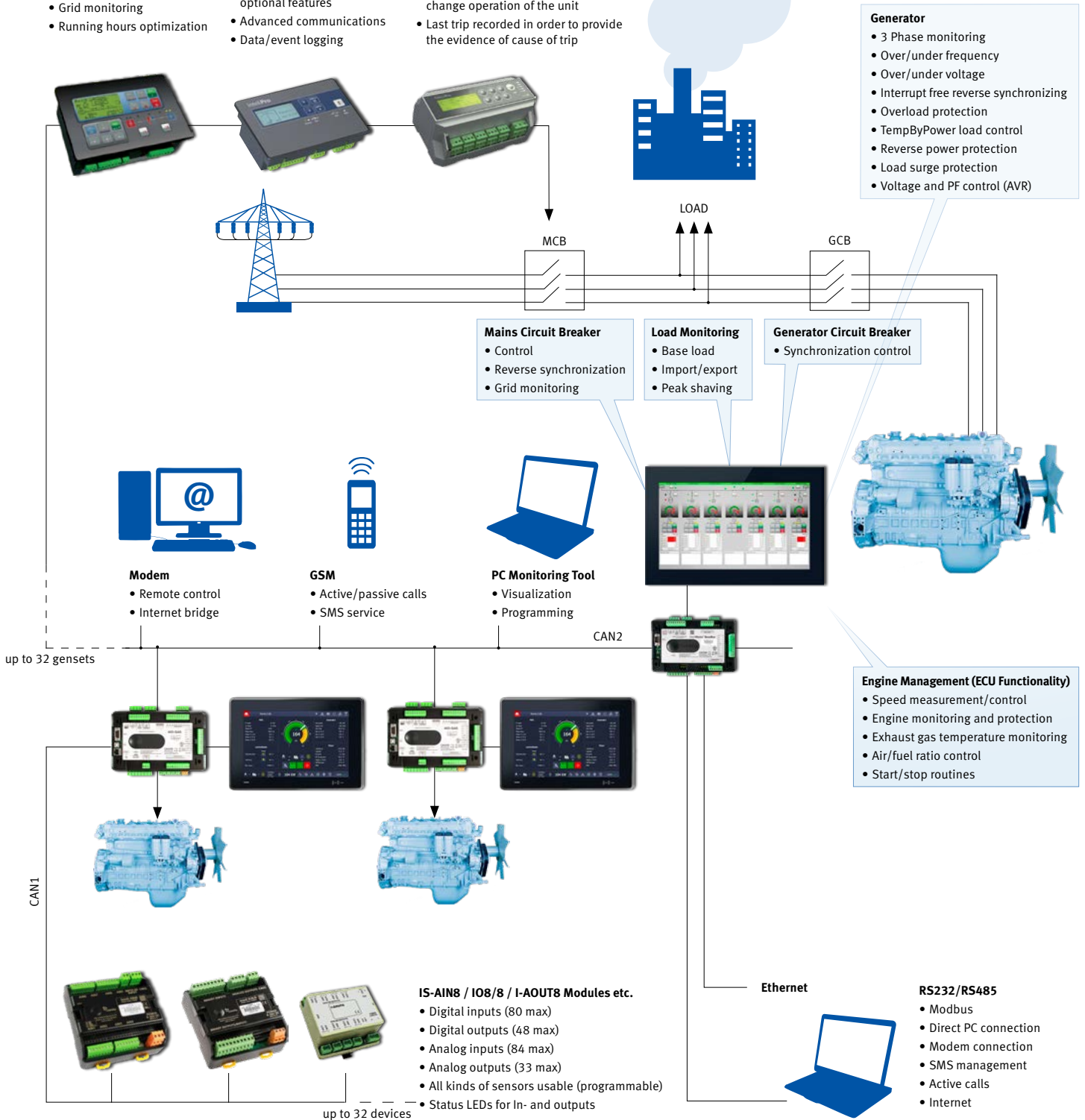

### Generator

- 3 Phase monitoring
- Over/under frequency
- Over/under voltage
- Interrupt free reverse synchronizing
- Overload protection
- TempByPower load control
- Reverse power protection
- Load surge protection
- Voltage and PF control (AVR)

### Mains Circuit Breaker

- Control
- Reverse synchronization
- Grid monitoring

### Load Monitoring

- Base load
- Import/export
- Peak shaving

### Generator Circuit Breaker

- Synchronization control

### Modem

- Remote control
- Internet bridge

### GSM

- Active/passive calls
- SMS service

### PC Monitoring Tool

- Visualization
- Programming

### Engine Management (ECU Functionality)

- Speed measurement/control
- Engine monitoring and protection
- Exhaust gas temperature monitoring
- Air/fuel ratio control
- Start/stop routines

### IS-AIN8 / IO8/8 / I-AOUT8 Modules etc.

- Digital inputs (80 max)
- Digital outputs (48 max)
- Analog inputs (84 max)
- Analog outputs (33 max)
- All kinds of sensors usable (programmable)
- Status LEDs for In- and outputs

### RS232/RS485

- Modbus
- Direct PC connection
- Modem connection
- SMS management
- Active calls
- Internet

ALL-IN-ONE Generator & CHP Control System

# Gas Engine Control Systems

Ready for VDE-AR-N 4110  
and VDE-AR-N-4105

## ALL-IN-ONE.GAS

The ALL-IN-ONE.GAS is an industrial control system for gas engine driven generator sets mainly used in CHP (Cogeneration) and power generation applications. The system controls, monitors and protects the generator set according to its configuration and defined setpoints. Preconfigured functions, scalable and configurable inputs and outputs, a built-in Soft PLC with large memory, extensive communication capabilities and an easy-to-change software allows to adapt the system to various applications with minimum effort. As the successor to the ALL-IN-ONE.NTC control system, the ALL-IN-ONE.GAS offers more computing power and memory capacity and is therefore ideally equipped for current and future requirements.



## General Features

- Predefined and adjustable functions for gas engine driven generator sets
- Large built-in Soft PLC for individual requirements and design of sophisticated applications like CHP (Cogeneration)
- SIL2 certification for selected channels
- Compliant to grid code requirements including VDE-AR-N 4105, VDE-AR-N 4110, BDEW directives and United Kingdom G99
- Support of a wide range of applications – Operation of single or multiple gas engines in island or mains parallel operation
- Power management function including new mode of effective engine run in mains parallel operation
- Plug&Play support of ALL-IN-ONE.Vision displays
- Automatic synchronization and power control (via speed governor or ECU)
- Event-based history with user selectable list of stored values; Real Time Clock (RTC); statistic values
- Overspeed and emergency stop detection

## Dimensions & Connections

### ALL-IN-ONE.GAS

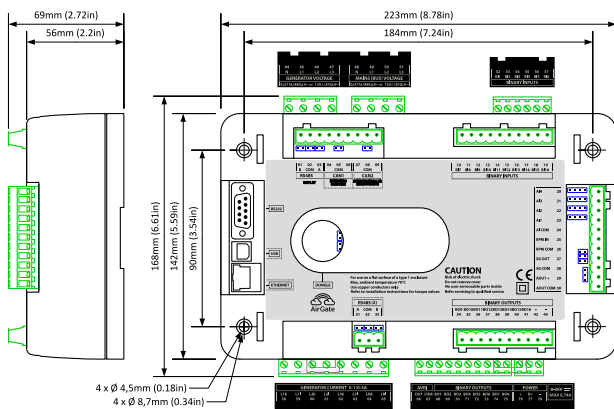

### ALL-IN-ONE.NTC

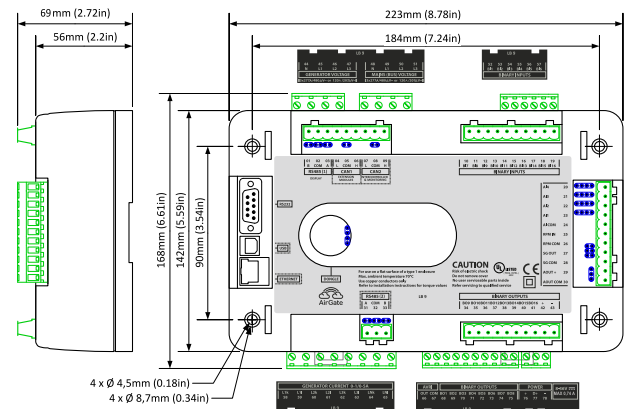





Comparison ALL-IN-ONE.GAS / ALL-IN-ONE.NTC

Features	ALL-IN-ONE.GAS	ALL-IN-ONE.NTC
Integrated Soft PLC	<ul style="list-style-type: none"> <li>■ PLC functions:                             <ul style="list-style-type: none"> <li>– Up to 32 PID blocks, 16 with binary outputs, 16 with analog outputs</li> <li>– Up to 256 AND/OR functional blocks</li> <li>– Up to 48 delay PLC blocks</li> <li>– Up to 32 ana switch PLC blocks</li> <li>– Up to 80 comparator PLC blocks</li> </ul> </li> <li>■ Up to 256 PLC binary outputs can be used</li> <li>■ Up to 96 PLC analog outputs can be used</li> <li>■ Up to 128 PLC setpoints can be used</li> </ul>	<ul style="list-style-type: none"> <li>■ PLC functions:                             <ul style="list-style-type: none"> <li>– Up to 22 PID blocks, 16 with binary outputs, 6 with analog outputs</li> <li>– Up to 100 AND/OR functional blocks</li> <li>– Up to 24 delay PLC blocks</li> <li>– Up to 16 ana switch PLC blocks</li> <li>– Up to 40 comparator PLC blocks</li> </ul> </li> <li>■ Up to 64 PLC setpoints can be used</li> </ul>
ECU support	<ul style="list-style-type: none"> <li>■ Supports up to 8 ECU blocks                             <ul style="list-style-type: none"> <li>– 128 analog inputs via J1939</li> <li>– 128 binary inputs via J1939</li> <li>– 16 analog outputs via J1939</li> <li>– 64 binary outputs via J1939</li> </ul> </li> </ul>	<ul style="list-style-type: none"> <li>■ Supports up to 3 ECU blocks                             <ul style="list-style-type: none"> <li>– 48 analog inputs via J1939</li> <li>– 48 binary inputs via J1939</li> <li>– 12 analog outputs via J1939</li> <li>– 48 binary outputs via J1939</li> </ul> </li> </ul>
Support of Start-Up Synchronization (SUS)	<ul style="list-style-type: none"> <li>■ Dedicated for installations where multiple generator sets shall be synced to common bus in very short time</li> <li>■ Dedicated for applications where e.g. soft magnetizing of a transformer is needed</li> </ul>	<ul style="list-style-type: none"> <li>■ No support</li> </ul>
Communication plug-in modules	<ul style="list-style-type: none"> <li>■ Supports the connection of up to 2 I-CB modules, means simultaneous use of e.g.                             <ul style="list-style-type: none"> <li>– I-CB Modbus, acting as a Modbus master</li> <li>– I-CB for e.g. MWM® engines with TEM control system</li> </ul> </li> </ul>	<ul style="list-style-type: none"> <li>■ Supports the connection of 1 I-CB module</li> </ul>
Number of supported modules (new I/O modules)	<ul style="list-style-type: none"> <li>■ Up to 15 AIN8 or AIN8TC modules</li> <li>■ Up to 15 IO8/8 modules</li> </ul>	<ul style="list-style-type: none"> <li>■ Up to 10 AIN8 or AIN8TC modules</li> <li>■ Up to 12 IO8/8 modules</li> </ul>
Support of the new AIO9/1 module	<ul style="list-style-type: none"> <li>■ 4 analog inputs for battery measurement up to 60 V</li> <li>■ 4 analog inputs for thermocouple measurements</li> <li>■ 1 analog output (PWM, mA, V)</li> </ul>	<ul style="list-style-type: none"> <li>■ 4 analog inputs for battery measurement up to 60 V</li> <li>■ 4 analog inputs for thermocouple measurements</li> <li>■ 1 analog output (PWM, mA, V)</li> </ul>
Air/fuel ratio (AFR) control algorithm	<ul style="list-style-type: none"> <li>■ Improved behavior in island operation – faster reaction of the air/gas mixer thanks to predefined fixed positions</li> <li>■ Adjustable PID speed – for stoichiometric applications with variable load</li> <li>■ 2 independent AFR mappings for 2 engine banks on V-engines or 2 different fuel types (e.g. biogas or natural gas)</li> </ul>	<ul style="list-style-type: none"> <li>■ Standard behavior</li> <li>■ Non adjustable PID speed</li> <li>■ 1 AFR mapping</li> </ul>
Languages	<ul style="list-style-type: none"> <li>■ minimum of 6 languages</li> </ul>	<ul style="list-style-type: none"> <li>■ English or English +1 (depending on size of conuguration)</li> </ul>



# Gas Engine Control Systems

## Controllers

**NEW**

P/N	Supersedes	Description
63.50.096		ALL-IN-ONE.GAS controller – universal gen-set controller (incl. AFR control <sup>1)</sup> and AirGate® technology)
63.50.104	63.50.102	ALL-IN-ONE.NTC controller – universal gen-set controller (incl. AFR control <sup>1)</sup> and AirGate® technology)
63.50.104-HSS	63.50.102-HSS	ALL-IN-ONE.NTC controller – universal gen-set controller P/N 63.50.104 incl. Plug-on module I-HSS-BIN6/10
63.50.082		Mini-ALL-IN-ONE controller – universal controller for small gen-sets (incl. AFR control <sup>2)</sup> – <b>for applications up to 75 kWel only</b> )

<sup>1)</sup> Requires hardware dongle P/N 63.50.061 or 63.50.062 for activation.

<sup>2)</sup> Requires hardware dongle P/N 63.50.085 for activation (**for applications up to 75 kWel only**).

## Display Units for ALL-IN-ONE.NTC/.GAS Controllers

**NEW**

**NEW**

P/N	Supersedes	Description
63.50.105		ALL-IN-ONE.Vision5 display – 5.7 in color display unit for ALL-IN-ONE.NTC and ALL-IN-ONE.GAS controllers
63.50.101		ALL-IN-ONE.Vision8 display – 8.0 in color display unit for ALL-IN-ONE.NTC and ALL-IN-ONE.GAS controllers
63.50.097		ALL-IN-ONE.Vision12 display – 12.0 in color touch display unit for ALL-IN-ONE.NTC and ALL-IN-ONE.GAS controllers
63.50.129	63.50.115, 63.50.120	ALL-IN-ONE.Vision18 display – 18.5 in color touch display unit for ALL-IN-ONE.NTC and ALL-IN-ONE.GAS controller

## Dongles

P/N	Supersedes	Description
63.50.061		Hardware dongle for ALL-IN-ONE.NTC/.GAS controllers – AFR-PCM Enables single island or single parallel with mains operation ■ Air/fuel ratio function for lean burn gas engines
63.50.062		Hardware dongle for ALL-IN-ONE.NTC/.GAS controllers – AFR-PCLSM+PMS ■ Enables multiple island parallel or multiple parallel with mains operation ■ Power management operation via CAN bus ■ Digital load sharing ■ Digital VAR sharing ■ Optimizing number of running engines: kW, kVA, load percentage or running hours based power management ■ Air/fuel ratio function for lean burn gas engines
63.50.085		Hardware dongle for Mini-ALL-IN-ONE – miniAFR-PCM ■ Enables single island or single parallel with mains operation ■ Air/fuel ratio function for lean burn gas engines ■ <b>For applications up to 75 kWel only</b>



## AIO Controllers

AIO.GAS Controller  
P/N 63.50.096

AIO.NTC Controller  
P/N 63.50.104

Mini-AIO Controller  
P/N 63.50.082



## Available Display Units for AIO.NTC and AIO.GAS Controllers



AIO.Vision18  
P/N 63.50.129



AIO.Vision12  
P/N 63.50.097



AIO.Vision8  
P/N 63.50.101



AIO.Vision5  
P/N 63.50.105

## Mains Controllers and Protections

P/N	Supersedes	Description	Equivalent to
63.50.064		Mains supervision controller – IM-NT	
63.50.064-BTB		Mains supervision controller Bus Tie Breaker – IM-NT BTB	
63.50.064-MCB		Mains supervision controller Mains Circuit Breaker – IM-NT MCB	
63.50.107		Mains decoupling relay – MainsPro	
63.50.095		Mains decoupling relay – MainsPro LITE	
63.50.139		Mains decoupling relay – MainsPro G99TT – <b>G99 Type Tested</b>	

**NEW**

## Accessories

P/N	Supersedes	Description	Equivalent to
63.50.092		Analog input extension module – I-AIN8	63.50.002 <sup>1)</sup>
63.50.002		Analog input extension module – IS-AIN8	
63.50.093	63.50.108	Analog input extension module for thermocouples only – I-AIN8TC	
63.50.118 <sup>2)</sup>	63.50.005	Input/output extension module – IO8/8	
63.50.007		Analog/binary input/output module – IGS-PTM	
63.50.007-HSS		Analog/binary input/output module P/N 63.50.007 incl. plug-on module I-HSS-BIN8	
63.50.011		AVR interface module – IG-AVRi	
63.50.010-100		Power supply transformer for IG-AVRi module, 100-120 VAC, 50-60 Hz	
63.50.010-230		Power supply for IG-AVRi module, 230-480 VAC, 50-60 Hz	
63.50.054		Analog output module – I-AOUT8	
63.50.075	63.50.006	Modem extension unit – I-LB+	
63.50.112	63.50.022	Internet communication module – IB-NT	
63.50.088		CAN repeater module – I-CR	

<sup>1)</sup> When replacing extension module P/N 63.50.002 (IS-AIN8), please note that extension module P/N 63.50.092 (I-AIN8) does not support thermocouples.

<sup>2)</sup> If more than 8 binary inputs are used for module P/N 63.50.005 (IS-BIN16/8) to be replaced, two extension modules P/N 63.50.118 (IO8/8) must be ordered as replacements.



# Gas Engine Control Systems

## MOT-Actuator MOTORTECH ELECTRIC ESM EXT ACTUATOR

MOTORTECH Actuator Replacement Kit for **WAUKESHA®** VHP Series Four® with ESM and Extender® Series Engines

### Features

- Drop in replacement
- Eliminates HEINZMANN® actuator
- Works on WAUKESHA® VHP L5774LT, L5794GSI/LT and L7044GSI

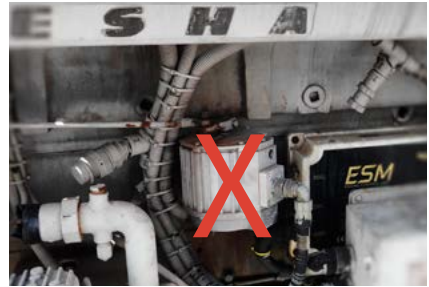

Replacement Kit for **WAUKESHA®** VHP Series Four® with ESM and Extender® Series Engines

P/N	Supersedes	Description	Equivalent to
63.04.176	63.04.175	Actuator replacement kit	214046



- Plug and play connection
- Does **not** require any
  - ▶ ESM software adjustment
  - ▶ Harness modification



- Mounting bracket included
- Allows easy drop in installation



- Lever included
- Simple connection to existing linkage

**INSTALLATION NOTICE:** If used on 6 cylinder WAUKESHA® VHP engines the IMPCO® throttle needs to be readjusted by flipping it over 180 degrees.



## ■ Sensor Systems

### Thermocouple Rails for **WAUKESHA**® 12 Cylinder VHP Engines

MOTORTECH offers a series of different Thermocouple Rail Upgrade Kits. The rails are installed in the “Vee” or on the side of the engine. These rail kits replace any prior system if installed.

#### Features

- Direct replacement for WAUKESHA® Thermocouple Conduit Assembly
- Available in different versions
- Prefabricated system guarantees easy exchange and installation
- Serviceable stainless steel wiring rail, no foam inside
- 14 thermocouples, Type K (NiCrNi), 90°
- Harness with flex conduit and J-Box or a large connector to fit the ESM
- Rail mounting brackets included in each kit
- 3 versions available

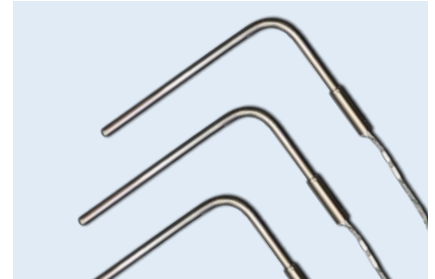

*Thermocouples, Type K, NiCrNi, 90°*



*Harness with flex conduit and fitting*

### Thermocouple Wiring Rail Kit with 8 ft Harness to Junction Box

#### Contains:

- 14 thermocouples, Type K (NiCrNi), 90°, equivalent to WAUKESHA® P/N 211288S
- 8.5 ft harness with flex conduit and fitting
- Rail mounting bracket (2 sets)
- Junction box P/N 06.05.076 with 44 terminals



P/N	Description	Equivalent to
D211359G-MOT	Thermocouple wiring rail kit	D211359G

# Sensor Systems



## Thermocouple Wiring Rail Kit with 50 ft Harness for Direct Wiring

*Contains:*

- 14 thermocouples, Type K (NiCrNi), 90°, equivalent to WAUKESHA® P/N 211288S, but 50 ft cable length
- 50 ft harness with flex conduit and fitting
- Rail mounting bracket (2 sets)

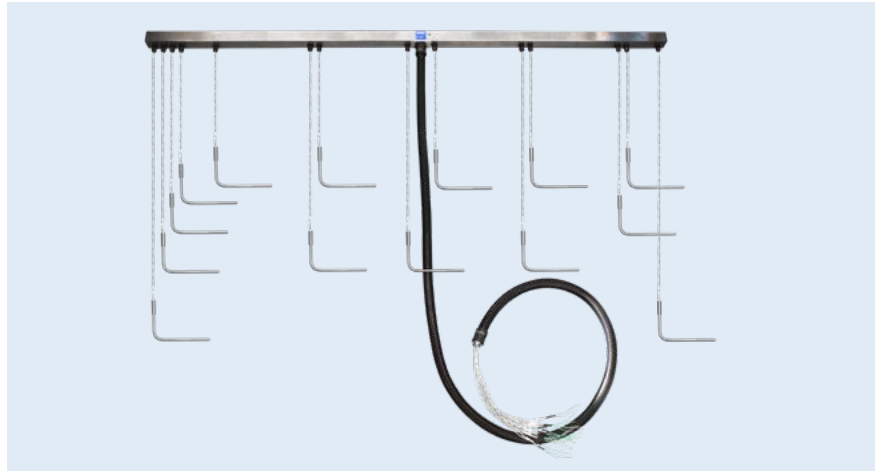

P/N	Description	Equivalent to
77.75.068-50	Thermocouple wiring rail kit	

## Thermocouple Wiring Rail Kit with 8 ft Harness and Connector to ESM Wiring System

*Contains:*

- 14 thermocouples, Type K (NiCrNi), 90°, equivalent to WAUKESHA® P/N 211288S
- 8 ft harness with flex conduit and 33 pole connector, socket
- Rail mounting bracket (2 sets)



P/N	Description	Equivalent to
77.75.066	Thermocouple wiring rail kit	214036D

### Optional Parts

P/N	Description	Required Quantity	Equivalent to
64.40.038	Fitting, 1/4 in, outer thread 1/4 in NPT	14 pcs per rail kit	194929



### Spare Parts

P/N	Description	Lead Length	For use with	Equivalent to
56.01.094-23	Thermocouple, Type K (NiCrNi), 90°	23 ft	D211359G-MOT, 77.75.066	211288S
56.01.094-59	Thermocouple, Type K (NiCrNi), 90°	59 ft	77.75.068-50	





# Sensor Systems

## Thermocouples



### Thermocouples for CATERPILLAR® G3500/B/C/E & G3600 Series Gas Engines

P/N	Supersedes	Description	Connector	Length	Application	Equivalent to
56.01.092-28		Thermocouple, Type K (NiCrNi), 90°	2 pole, pin, 180°	28.00 in	G3500/B series	383-2989, 241-9591, 175-5341, 61-0407 <sup>1)</sup>
56.01.098-34		Thermocouple, Type K (NiCrNi), 90°	3 pole, pin, 180°	34.00 in	G3500C/E, G3600 series	383-2988, 152-0807
56.01.183-16		Thermocouple, Type K (NiCrNi), 180°	3 pole, pin, 180°	16.00 in	G3500C/E series	383-2981, 207-2371

<sup>1)</sup> If the MOTORTECH thermocouple is used to replace thermocouple 175-5341 or 61-0407, the engine wiring harness must be modified by replacing the bullet connector with kit P/N 75.30.046. Please order separately with each thermocouple.

### Connector Kit for Thermocouples

P/N	Description	Equivalent to
75.30.046	Connector kit incl. housing, contacts and wedge lock	

### Thermocouple for CATERPILLAR® G3500/B Series Gas Engines – For use with AlphaRail Wiring Rail System for Temperature Control

P/N	Supersedes	Description	Connector	Length	Application	Equivalent to
56.01.099-28		Thermocouple, Type K (NiCrNi), 90°	MIL, 3 pole, pin, 180°, bay	28.00 in	G3500/B series	383-2989, 241-9591, 175-5341, 61-0407 <sup>1)</sup>

<sup>1)</sup> Only for use when an AlphaRail wiring rail is installed and the OEM thermocouples mentioned need to be replaced.

### Thermocouple for CUMMINS® QSK60G and QSV81/91G – For use with AlphaRail Wiring Rail System for Temperature Control

P/N <sup>1)</sup>	Description	Wiring Rail Connector	Length	Equivalent to
56.01.091-25	Thermocouple, Type K (NiCrNi), 90°	MIL, 3 pole, pin, 180°, bay	25.00 in	

<sup>1)</sup> Other lengths available on request.

### Thermocouple and Connecting Cable for MAN® E08, E26, E28 & E32 Series Gas Engines

P/N	Supersedes	Description	Connector	Length	Equivalent to
51.27421-0158-MOT		Thermocouple, Type K (NiCrNi), 90°	4 pole, socket, 180°	14.00 in	51.27421-0158
06.30.112		Connecting cable for thermocouple	4 pole, pin, 180°	210.00 in	51.25411-6028

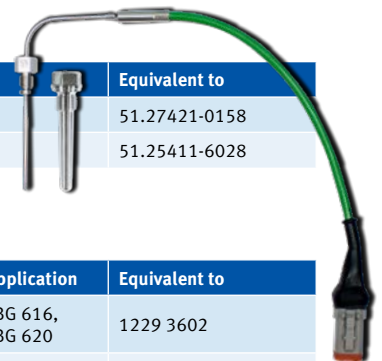

### Thermocouples for MWM®/DEUTZ® Gas Engines <sup>1)</sup>

P/N	Supersedes	Description	Application	Equivalent to
1229 3602-MOT		Thermocouple, Type K (NiCrNi)	TBG 616, TBG 620	1229 3602
1229 6754-MOT		Thermocouple, Type K (NiCrNi)	TBG 616	1229 6754
1229 9387-MOT		Thermocouple, Type K (NiCrNi)	TBG 616, TBG 620, TCG 2016, TCG 2020	1229 9387
1229 9487-MOT		Thermocouple, Type K (NiCrNi)	TBG 616, TCG 2016	1229 9487
1232 2279-MOT		Thermocouple, Type K (NiCrNi)	TCG 2016	1232 2279
1232 3810-MOT		Thermocouple, Type K (NiCrNi)	TBG 616, TBG 620, TCG 2016, TCG 2020	1232 3810



<sup>1)</sup> Available from Q4/2019.

## Thermocouples for WAUKESHA® AT25GL & AT27GL Series Gas Engines

P/N	Figure	Description	Wiring Rail Connector	Length		Equivalent to
56.01.005-42	4	Thermocouple, Type K (NiCrNi), 180°	3 pole socket, 180°	42.00 in		295962
56.01.005-53	4	Thermocouple, Type K (NiCrNi), 180°	3 pole socket, 180°	53.00 in		295962A
56.01.005-70	4	Thermocouple, Type K (NiCrNi), 180°	3 pole socket, 180°	70.00 in		295962B
56.01.005-81	4	Thermocouple, Type K (NiCrNi), 180°	3 pole socket, 180°	81.00 in		295962C

## Thermocouples for use with AlphaRail Wiring Rail System for Temperature Control

P/N	Figure	Description	Wiring Rail Connector	Length		Equivalent to
56.01.090-10	5	Thermocouple, Type K (NiCrNi), 90°	MIL, 3 pole, pin, 180°, bay.	10.00 in		
56.01.090-20	5	Thermocouple, Type K (NiCrNi), 90°	MIL, 3 pole, pin, 180°, bay.	20.00 in		
56.01.090-25	5	Thermocouple, Type K (NiCrNi), 90°	MIL, 3 pole, pin, 180°, bay.	25.00 in		
56.01.090-30	5	Thermocouple, Type K (NiCrNi), 90°	MIL, 3 pole, pin, 180°, bay.	30.00 in		
56.01.090-40	5	Thermocouple, Type K (NiCrNi), 90°	MIL, 3 pole, pin, 180°, bay.	40.00 in		
56.01.090-60	5	Thermocouple, Type K (NiCrNi), 90°	MIL, 3 pole, pin, 180°, bay.	60.00 in		
56.01.090-K <sup>1)</sup>	5	Thermocouple, Type K (NiCrNi), 90°	MIL, 3 pole, pin, 180°, bay.	177.00 in		
56.01.180-10	6	Thermocouple, Type K (NiCrNi), 180°	MIL, 3 pole, pin, 180°, bay.	10.00 in		
56.01.180-20	6	Thermocouple, Type K (NiCrNi), 180°	MIL, 3 pole, pin, 180°, bay.	20.00 in		
56.01.180-25	6	Thermocouple, Type K (NiCrNi), 180°	MIL, 3 pole, pin, 180°, bay.	25.00 in		
56.01.180-30	6	Thermocouple, Type K (NiCrNi), 180°	MIL, 3 pole, pin, 180°, bay.	30.00 in		
56.01.180-40	6	Thermocouple, Type K (NiCrNi), 180°	MIL, 3 pole, pin, 180°, bay.	40.00 in		
56.01.180-60	6	Thermocouple, Type K (NiCrNi), 180°	MIL, 3 pole, pin, 180°, bay.	60.00 in		
56.01.180-K <sup>1)</sup>	6	Thermocouple, Type K (NiCrNi), 180°	MIL, 3 pole, pin, 180°, bay.	177.00 in		

<sup>1)</sup> Comes with loose connector and 177 in lead length.



## Sensor Systems

### Sensors

For several years MOTORTECH offers oxygen sensors that can be used as replacements for the OEM part. Shielded and unshielded versions can be selected.



#### Oxygen Sensors for **CATERPILLAR**® G3400 and G3500 Series Gas Engines

P/N	Figure	Description	Connector	Length	Equivalent to
19.60.027	1	Oxygen sensor, unshielded	MIL, 6 pole, pin, 180°	10.00 in	196-5391, 3E-7639
19.60.029	2	Oxygen sensor, shielded	MIL, 6 pole, pin, 180°	51.00 in	141-2494

#### Oxygen Sensor for **WAUKESHA**® VHP G/GSI/LT Series Gas Engines

P/N	Figure	Description	Connector	Length	Equivalent to
A740106E-MOT	3	Oxygen sensor	2 pole, pin, 180°	17.00 in	A740106E, A740106D, A740106C

#### Oxygen Sensor Harness for **WAUKESHA**® Gas Engines

P/N	Figure	Description	Connector	Length	Equivalent to
06.30.110		Oxygen sensor harness	9 pole, pin, 180°	90.00 in	A740735

#### UEGO Oxygen Sensor

P/N	Figure	Description	Connector	Length	Equivalent to
19.60.007	4	UEGO oxygen sensor	8 pole, pin, 180°	15.75 in	DL08311001
19.71.013		UEGO oxygen sensor lead	8 pole, socket, 180°	79.00 in	DL08311003



## Oxygen Sensor – Heated

P/N	Figure	Description	Connector	Length	Equivalent to
19.60.015	5	Oxygen sensor, heated	4 pole, pin, 180°	1.15 ft (0.35 m)	
19.71.015-2		Oxygen sensor lead	4 pole, socket, 180°	6.50 ft (2.00 m)	
19.71.015-3		Oxygen sensor lead	4 pole, socket, 180°	9.80 ft (3.00 m)	
19.71.015-15		Oxygen sensor lead	4 pole, socket, 180°	49.00 ft (15.00 m)	
19.71.015-30		Oxygen sensor lead	4 pole, socket, 180°	98.00 ft (30.00 m)	

## Oxygen Sensor – Non Heated

P/N	Figure	Description	Connector	Length	Equivalent to
19.60.004	5	Oxygen sensor, non heated	2 pole, pin, 180°	1.15 ft (0.35 m)	
19.71.004-32		Oxygen sensor lead	2 pole, socket, 180°	32.00 ft (9.75 m)	
19.71.004-50		Oxygen sensor lead	2 pole, socket, 180°	50.00 ft (15.00 m)	
19.71.004-100		Oxygen sensor lead	2 pole, socket, 180°	100.00 ft (30.00 m)	

To increase life time of these critical sensors, there is also a stainless steel weld hub available that is welded into the exhaust pipe.

A heat shield can be screwed on top of the weld hub. This way the sensor does reach directly into the exhaust gas stream with all its deposits and the heat shield protects the sensor against transient temperature from the hot exhaust manifold.



## Accessories for Oxygen Sensors

P/N	Figure	Description	Equivalent to
19.60.022	6	Heat shield	
19.60.023	7	Welding adaptor	



## Sensor Systems

### MAT – Manifold Air Temperature Sensors

P/N	Figure	Supersedes	Description	Thread	Fitting Length	Equivalent to
56.01.004	7	56.01.021	MAT sensor	G1/2	2.00 in (50 mm)	
56.01.011	7		MAT sensor	G1/2	3.00 in (75 mm)	
56.01.017	7		MAT sensor	G1/2	4.00 in (100 mm)	

### Temperature Sensor for MAN® E08 & E28 Series Gas Engines

P/N	Figure	Description	Thread	Fitting Length	Equivalent to
56.01.025	8	Temperature sensor with switch	M14x1.5	1.60 in (40 mm)	51.27420-0008

### MAP – Manifold Absolute Pressure Sensor (Automotive Design)

P/N	Figure	Description	Connector	Length	Equivalent to
19.60.002	9	MAP sensor	3 pole, socket		6910-314
19.71.002		MAP sensor lead	3 pole, pin, 180°	26.00 ft (8.00 m)	DL08220604

### MAP – Manifold Absolute Pressure Sensors (Industrial Design)

P/N	Figure	Supersedes	Description	Thread	Pressure Range	Equivalent to
56.01.001	10		MAP sensor	G1/4	0 to 10.0 bar	
56.01.002	10		MAP sensor	G1/4	0 to 6.0 bar	
56.01.010	10		MAP sensor	G1/4	0 to 16.0 bar	
56.02.017	10	56.02.016	MAP sensor	G1/4	0 to 3.0 bar	



7



8



9



10

## Sensor Harnesses for MAN® Gas Engines

MOTORTECH sensor harnesses are individually designed for use on MAN® gas engines. The harnesses are completely prewired and equipped with all sensors required to measure the relevant operating data of the engine. To transfer the measured values to the master control, a matching connecting harness is plugged to the main connector of the sensor harness.

### Features

- Prewired harness with engine specific layout
- Sensors for measuring of following values: <sup>1)</sup>
  - ▶ Oil pressure and temperature
  - ▶ Coolant pressure and temperature
  - ▶ Manifold pressure and temperature
  - ▶ Engine speed
- Including all brackets and adaptors for mounting harness and sensors
- Connecting harness to master control

<sup>1)</sup> Number and type of sensors may vary due to different engine models.

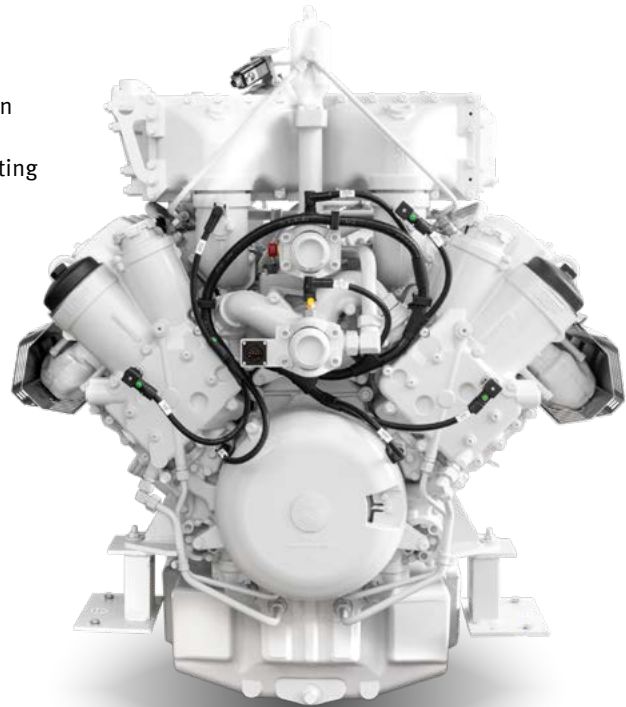

### Sensor Harnesses for MAN® E0834 Series Gas Engines

P/N	Supersedes	Description	Engine Model	Equivalent to
06.30.024		Harness with all sensors	E0834 E302/312	
06.30.022		Connecting harness to master control	E0834 E302/312	
06.30.101		Harness with all sensors	E0834 LE302	
06.30.102		Connecting harness to master control	E0834 LE302	

### Sensor Harnesses for MAN® E0836 Series Gas Engines

P/N	Supersedes	Description	Engine Model	Equivalent to
06.30.023		Harness with all sensors	E0836 E302/312	
06.30.022		Connecting harness to master control	E0836 E302/312	
06.30.026		Harness with all sensors	E0836 LE202	
06.30.027		Connecting harness to master control	E0836 LE202	
06.30.169		Harness with all sensors	E0836 LE302	
06.30.167-15000		Connecting harness to master control	E0836 LE302	

### Sensor Harnesses for MAN® E2676 Series Gas Engines

P/N	Supersedes	Description	Engine Model	Equivalent to
06.30.164		Harness with all sensors	E2676 LE202/212	
06.30.165-15000		Connecting harness to master control	E2676 LE202/212	

### Sensor Harnesses for MAN® E2876 Series Gas Engines

P/N	Supersedes	Description	Engine Model	Equivalent to
06.30.042		Harness with all sensors	E2876 E312	
06.30.043		Connecting harness to master control	E2876 E312	
06.30.093		Harness with all sensors	E2876 TE302	
06.30.060		Connecting harness to master control	E2876 TE302	
06.30.025		Harness with all sensors	E2876 LE202/302	
06.30.028		Connecting harness to master control	E2876 LE202/302	



## Sensor Systems

### Sensor Harnesses for MAN® E2848 Series Gas Engines

P/N	Supersedes	Description	Engine Model	Equivalent to
06.30.053		Harness with all sensors	E2848 LE322	
06.30.054		Connecting harness to master control	E2848 LE322	

### Sensor Harnesses for MAN® E2842 Series Gas Engines

P/N	Supersedes	Description	Engine Model	Equivalent to
06.30.055		Harness with all sensors	E2842 E312	
06.30.056		Connecting harness to master control	E2842 E312	
06.30.040		Harness with all sensors	E2842 LE312	
06.30.039		Adaptor harness	E2842 LE312	
06.30.041		Adaptor harness	E2842 LE312	
06.30.044		Connecting harness to master control	E2842 LE312	
06.30.053		Harness with all sensors	E2842 LE322	
06.30.054		Connecting harness to master control	E2842 LE322	

### Sensor Harnesses for MAN® E3268 Series Gas Engines

P/N	Supersedes	Description	Engine Model	Equivalent to
06.30.162		Harness with all sensors	E3268 LE212/222	
06.30.163-15000		Connecting harness to master control	E3268 LE212/222	

### Sensor Harnesses for MAN® E3262 Series Gas Engines

P/N	Supersedes	Description	Engine Model	Equivalent to
06.30.166		Harness with all sensors	E3262 E302	
06.30.162		Harness with all sensors	E3262 LE202/212	
06.30.163-15000		Connecting harness to master control	E3262 E302/LE202/212	

### CAN Connecting Harnesses for Data Logger to Master Control on MAN® E26 and E32 Series Gas Engines

P/N	Supersedes	Description	Connector	Length	Equivalent to
06.05.089-65		CAN connecting harness	4 pole, socket	65.00 ft (20.00 m)	
06.05.092-65		CAN connecting harness	6 pole, socket	65.00 ft (20.00 m)	

## Harnesses for **WOODWARD®** L-Series Control

P/N	Supersedes	Description	Connector	Length	Equivalent to
13.20.002		Programming harness for L-Series ITB, LC50	12 pole, socket	180.00 in (4.60 m)	02-0004-174
13.20.003-295		Harness for L-Series	12 pole, socket	295.00 in (7.50 m)	
13.20.003-590		Harness for L-Series	12 pole, socket	590.00 in (15.00 m)	
13.20.004		Programming harness for L-Series	12 pole, socket	6.90 in (0.18 m)	8923-1061

## Harnesses for **WOODWARD®** ProAct Series

P/N	Supersedes	Description	Connector	Length	Equivalent to
06.02.026-5		Harness for ProAct IV governor	MIL, 24 pole, socket, 90°	5.00 ft (1.50 m)	
06.02.026-15		Harness for ProAct IV governor	MIL, 24 pole, socket, 90°	15.00 ft (4.50 m)	
06.02.026-25		Harness for ProAct IV governor	MIL, 24 pole, socket, 90°	25.00 ft (7.50 m)	
06.02.026-50		Harness for ProAct IV governor	MIL, 24 pole, socket, 90°	50.00 ft (15.00 m)	
06.30.100		Harness for ProAct ISC integrated speed control	MIL, 24 pole, socket, 180°	50.00 ft (15.00 m)	

## Air/Fuel Ratio Control Systems

### VariFuel2 MOTORTECH AIR/GAS MIXER

MOTORTECH's VariFuel2 is a high-tech variable Venturi type air/gas mixer that can constantly adjust to any fuel changes and allows the engine to operate at its most efficient point. Coupled to an air/fuel ratio controller, lean-burn or stoichiometric, it precisely regulates the mixture. The VariFuel2 is very popular for applications with constant changes in calorific value of fuel.

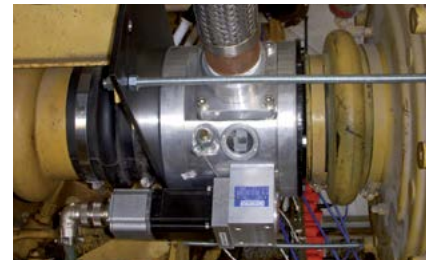

### VariFuel2+ MOTORTECH AIR/GAS MIXER

VariFuel2+ air/gas mixers are specially designed for use with natural gas-powered gas engines and are based on the general operating principle of the VariFuel2 series. The geometry of the built-in fuel ring, adapted to the application, ensures improved engine starting behavior and control of the air/gas mixture in natural gas operation.

VariFuel2 and VariFuel2+ air/gas mixer series 100, 140, 200, 250, 300 and 350 are available for engines with an air requirement up to 12,000 m<sup>3</sup>/h and are equipped with a high precision stepper motor which is extremely precisely actuated by the VariStep3 stepper motor driver. Different flow bodies and variable gas inlet and mixture outlet configurations allow flexible adaptation of the gas mixer to the respective application.

VariFuel2 and VariFuel2+ air/gas mixers are suitable for a wide range of gas types:

- Natural gas
- Biogas
- Landfill gas
- Sewage gas
- Wood gas
- Wellhead gas
- Mine gas



Series 200-120



Series 100-60



Series 140-80



Series 250-150



Series 300-190



Series 350-225

## Basic Design

The main task of a gas mixer is to mix the fuel (gas) and air in such a way that optimum combustion takes place in the gas engine. High efficiency and low emissions, in accordance with current regulations, are the decisive parameters for optimization.

In the VariFuel2, air and gas are mixed according to the Venturi principle. The air is sucked through the air intake into the Venturi nozzle by the suction vacuum of the engine. Due to the Venturi principle, a vacuum is created at the narrowest point, which sucks the gas through the gas inlet. In this way, gas and air are mixed and released at the mixture outlet.

Various mixer sizes and flow bodies **1** in the Venturi nozzle allow different volumetric flows to be achieved.

## Regulation of the Air/Fuel Mixture

The fuel (gas) is guided into the nozzle via the adjustable openings **2** in a fuel ring **3**. The openings of the fuel ring are adjusted by a drive belt **4** via a stepper motor. The stepper motor **5** can be controlled by the VariStep3 stepper motor driver, which can process the signals of a master control.

In addition, the VariFuel2 air/gas mixers are equipped with a port for an air pressure gauge and a connection for the pulse line of a zero pressure regulator.

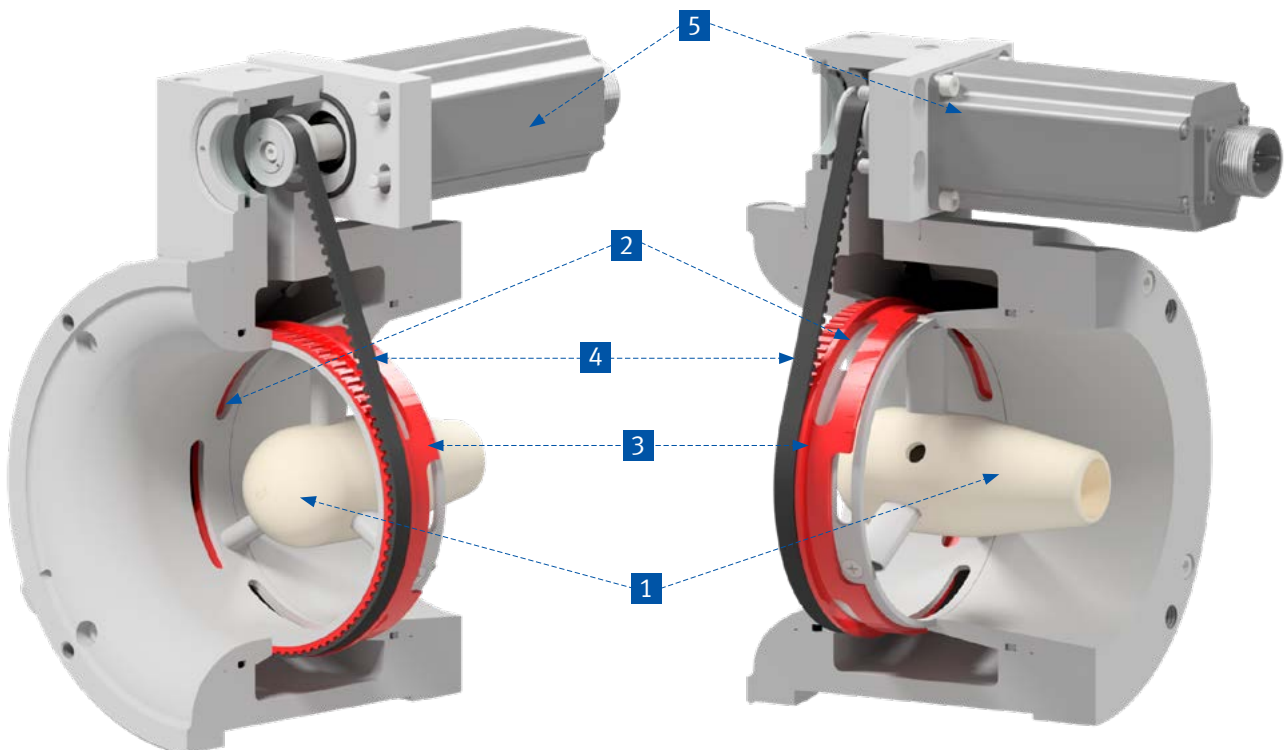

# Air/Fuel Ratio Control Systems



Scan the QR code® to download the specification table to specify a suitable air/gas mixer for your application.

## Features

VariFuel2/VariFuel2+ Series	100-60	140-80	200-120	250-150	300-190	350-225
Air requirement	100 to 650 m <sup>3</sup> /h	200 to 1,300 m <sup>3</sup> /h	500 to 3,200 m <sup>3</sup> /h	1,800 to 5,200 m <sup>3</sup> /h	3,400 to 8,500 m <sup>3</sup> /h	6,000 to 12,000 m <sup>3</sup> /h
Available flow body sizes	23.0 to 55.0 mm in steps of 2.5 mm	23.0 to 72.5 mm in steps of 2.5 mm	23.0 to 107.5 mm in steps of 2.5 mm	23.0 to 110.0 mm in steps of 2.5 mm	35.0 to 140.0 mm in steps of 5.0 mm	35.0 to 150.0 mm in steps of 5.0 mm
Flexible inlet and outlet configuration	x	x	x	x	x	x
Driven by timing belt	x	x	x	x	x	x
Number of gas pressure gauge connections	1	1	1	1	1	1
Number of air pressure gauge connections	1	1	1	1	1	1
Hose connection for air inlet	x	x	x	x	x	x
Various flange connections for outlet	x	x	x	x	x	x
Various flange connections for gas inlet	x	x	x	x	x	x
The central flow body is fixed with 3 profiles.	x	x	x	x	x	x

## Accessories



### 2 Flow Bodies

Depending on the application, suitable flow bodies in different sizes are used to influence the flow velocity.

- Flow bodies are made of aluminum and, from a diameter of 60 mm, of high-strength thermoplastic material.

### 3 Outlet Flange Kits

Outlet flanges for easy connection of the VariFuel2/VariFuel2+ air/gas mixers to typical gas engines.

- Standard and engine-specific types are available.

### 4 Gas Inlet Flanges

Gas inlet flanges for connecting the gas train to the VariFuel2/VariFuel2+ air/gas mixer.

- Versions with different thread sizes are available for each gas mixer series.

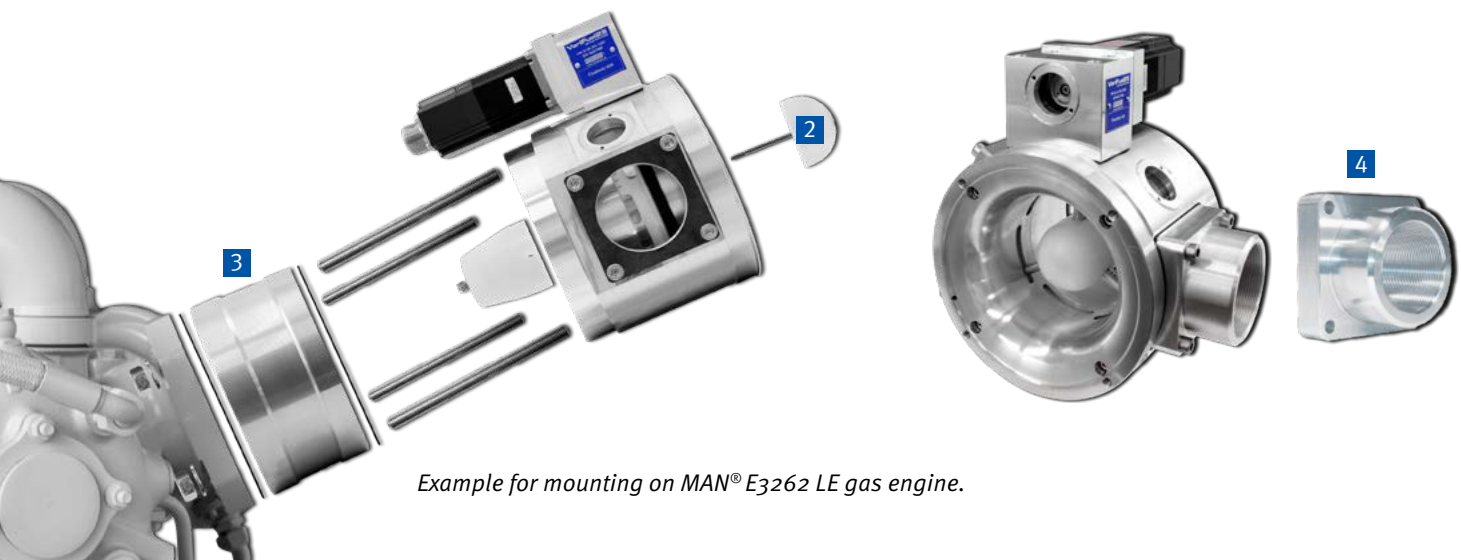

Example for mounting on MAN® E3262 LE gas engine.

## System Overview

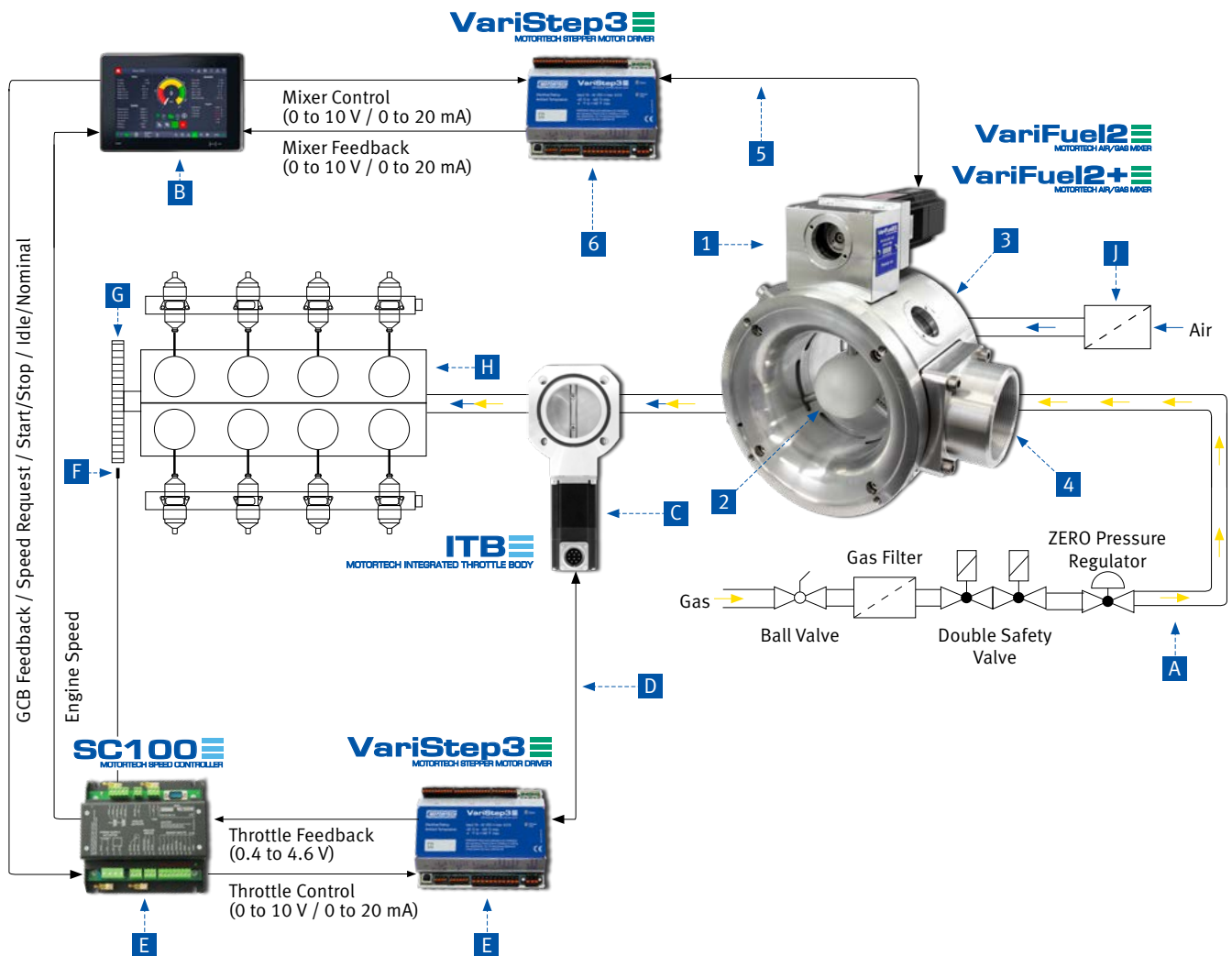

VariFuel2/VariFuel2+ Air/Gas Mixer

### Required Accessories

- 1** VariFuel2/VariFuel2+ air/gas mixer
- 2** Flow body
- 3** Outlet flange
- 4** Gas inlet flange
- 5** Stepper motor harness
- 6** VariStep3 stepper motor driver

### Description

- A** Gastrain (ZERO Pressure Regulator required)
- B** Master control / Emission control system
- C** ITB throttle body with integrated stepper motor
- D** Stepper motor harness
- E** Speed control kit incl.
  - VariStep3 stepper motor driver
  - SC100 speed control
- F** Magnetic pickup
- G** Flywheel
- H** Engine
- J** Air filter



# Air/Fuel Ratio Control Systems

## 1 VariFuel2 Air/Gas Mixer – with Digital Stepper Motor <sup>1)</sup>

P/N	Supersedes	Description
30.45.100-60D	30.45.100-50D	VariFuel2 air/gas mixer, series 100-60
30.45.140-80D	30.45.140-65D	VariFuel2 air/gas mixer, series 140-80
30.45.200-120D	30.45.200-100D	VariFuel2 air/gas mixer, series 200-120
30.45.250-150D		VariFuel2 air/gas mixer, series 250-150
30.45.300-190D		VariFuel2 air/gas mixer, series 300-190
30.45.350-225D		VariFuel2 air/gas mixer, series 350-225

<sup>1)</sup> Manually adjustable VariFuel2 air/gas mixers no longer available. Please consult factory for alternative products.

## 1 VariFuel2+ Air/Gas Mixer – with Digital Stepper Motor

P/N	Supersedes	Description
30.45.101-60D		VariFuel2+ air/gas mixer, series 100-60
30.45.141-80D		VariFuel2+ air/gas mixer, series 140-80
30.45.201-120D		VariFuel2+ air/gas mixer, series 200-120
30.45.251-150D		VariFuel2+ air/gas mixer, series 250-150
30.45.301-190D		VariFuel2+ air/gas mixer, series 300-190
30.45.351-225D		VariFuel2+ air/gas mixer, series 350-225

## 2 Flow Bodies

P/N	Supersedes	Description	Diameter	VariFuel2/VariFuel2+ Series (D= digital / M= manual)					
				100-60D/M	140-80D/M	200-120D/M	250-150D/M	300-190D/M	350-225D/M
31.01.720-23.0-3		Flow body	23.0 mm	x	x	x	x		
31.01.720-27.5-3		Flow body	27.5 mm	x	x	x	x		
31.01.720-30.0-3		Flow body	30.0 mm	x	x	x	x		
31.01.720-32.5-3		Flow body	32.5 mm	x	x	x	x		
31.01.720-35.0-3		Flow body	35.0 mm	x	x	x	x	x	x
31.01.720-37.5-3		Flow body	37.5 mm	x	x	x	x		
31.01.720-40.0-3		Flow body	40.0 mm	x	x	x	x	x	x
31.01.720-42.5-3		Flow body	42.5 mm	x	x	x	x		
31.01.720-45.0-3		Flow body	45.0 mm	x	x	x	x	x	x
31.01.720-47.5-3		Flow body	47.5 mm	x	x	x	x		
31.01.720-50.0-3		Flow body	50.0 mm	x	x	x	x	x	x
31.01.720-52.5-3		Flow body	52.5 mm	x	x	x	x		
31.01.720-55.0-3		Flow body	55.0 mm	x	x	x	x	x	x
31.01.720-57.5-3		Flow body	57.5 mm		x	x	x		
31.01.720-60.0-3		Flow body	60.0 mm		x	x	x	x	x
31.01.720-62.5-3		Flow body	62.5 mm		x	x	x		
31.01.720-65.0-3		Flow body	65.0 mm		x	x	x	x	x
31.01.720-67.5-3		Flow body	67.5 mm		x	x	x		
31.01.720-70.0-3		Flow body	70.0 mm		x	x	x	x	x
31.01.720-72.5-3		Flow body	72.5 mm		x	x	x		
31.01.720-75.0-3		Flow body	75.0 mm			x	x	x	x
31.01.720-77.5-3		Flow body	77.5 mm			x	x		
31.01.720-80.0-3		Flow body	80.0 mm			x	x	x	x
31.01.720-82.5-3		Flow body	82.5 mm			x	x		
31.01.720-85.0-3		Flow body	85.0 mm			x	x	x	x
31.01.720-87.5-3		Flow body	87.5 mm			x	x		

## 2 Flow Bodies

P/N	Supersedes	Description	Diameter	VariFuel2/VariFuel2+ (D= digital / M= manual)					
				100-60D/M	140-80D/M	200-120D/M	250-150D/M	300-190D/M	350-225D/M
31.01.720-90.0-3		Flow body	90.0 mm			x	x	x	x
31.01.720-92.5-3		Flow body	92.5 mm			x	x		
31.01.720-95.0-3		Flow body	95.0 mm			x	x	x	x
31.01.720-97.5-3		Flow body	97.5 mm			x	x		
31.01.720-100.0-3		Flow body	100.0 mm			x	x	x	x
31.01.720-102.5-3		Flow body	102.5 mm			x	x		
31.01.720-105.0-3		Flow body	105.0 mm			x	x	x	x
31.01.720-107.5-3		Flow body	107.5 mm			x	x		
31.01.720-110.0-3		Flow body	110.0 mm				x	x	x
31.01.720-115.0-3		Flow body	115.0 mm					x	x
31.01.720-120.0-3		Flow body	120.0 mm					x	x
31.01.720-125.0-3		Flow body	125.0 mm					x	x
31.01.720-130.0-3		Flow body	130.0 mm					x	x
31.01.720-135.0-3		Flow body	135.0 mm					x	x
31.01.720-140.0-3		Flow body	140.0 mm					x	x
31.01.720-145.0-3		Flow body	145.0 mm						x
31.01.720-150.0-3		Flow body	150.0 mm						x

## 3 Outlet Flange Kits

P/N	Description	VariFuel2/VariFuel2+ (D= digital / M= manual)					
		100-60D/M	140-80D/M	200-120D/M	250-150D/M	300-190D/M	350-225D/M
31.01.764	Outlet flange kit, gas relaxation section for throttle, series 50	x					
31.01.765	Outlet flange kit, gas relaxation section for throttle, series 100	x					
31.01.766	Outlet flange kit, gas relaxation section for throttle, series 50	x					
31.01.768	Outlet flange kit, for MAN® E0834 LE302, E0836 LE202	x					
31.01.750	Outlet flange kit, for MAN® E2876 LE202/212/302		x				
31.01.752	Outlet flange kit, welding neck flange, DN100		x				
31.01.753	Outlet flange kit, for MAN® E0836 LE202		x				
31.01.755	Outlet flange kit, DN65-PN6		x				
31.01.756	Outlet flange kit, for MAN® E2842 E312		x				
31.01.757	Outlet flange kit, for throttle, series 100		x				
31.01.762	Outlet flange kit, gas relaxation section for throttle, series 100		x				
31.01.763	Outlet flange kit, gas relaxation section for throttle, series 140		x				
31.01.773	Outlet flange kit, for LIEBHERR® G934, G944		x				
31.01.781	Outlet flange kit, for LIEBHERR® G946		x				
31.02.113	Outlet flange kit, for MAN® E2676 E302		x				
31.02.115	Outlet flange kit, for MAN® E3262 E302		x				
31.02.118	Outlet flange kit, for MAN® E0836 LE302		x				
31.01.751	Outlet flange kit, welding neck flange, DN150			x			
31.01.754	Outlet flange kit, for MAN® E2842 LE312			x			
31.01.758	Outlet flange kit, hose connection, DN200			x			
31.01.759	Outlet flange kit, for MAN® E2676 LE202/212, E2876 LE202/212/302			x			
31.01.761	Outlet flange kit, welding neck flange, DN150 – aluminum			x			

## Air/Fuel Ratio Control Systems

### 3 Outlet Flange Kits

P/N	Description	VariFuel2/VariFuel2+ Series (D= digital / M= manual)					
		100-60D/M	140-80D/M	200-120D/M	250-150D/M	300-190D/M	350-225D/M
31.01.767	Outlet flange kit, for DEUTZ® TCG2015V6/V8			x			
31.01.772	Outlet flange kit, for SHENGDONG® 600GF1-PS			x			
31.01.774	Outlet flange kit, for LIEBHERR® G936			x			
31.01.775	Outlet flange kit, for LIEBHERR® G9508			x			
31.01.776	Outlet flange kit, for LIEBHERR® G9512			x			
31.01.777	Outlet flange kit, for LIEBHERR® G946, DOOSAN® GV158.3013.D			x			
31.01.778	Outlet flange kit, for LIEBHERR® G9508			x			
31.01.779	Outlet flange kit, linkage for 2 VariFuel2 – series 200-1xx			x			
31.01.780	Outlet flange kit, for MAN® E2848/42 LE322, E3268 LE2xx, E3262 LE2xx			x			

### 4 Gas Inlet Flanges

P/N	Description	Thread	VariFuel2/VariFuel2+ (D= digital / M= manual)					
			100-60D/M	140-80D/M	200-120D/M	250-150D/M	300-190D/M	350-225D/M
30.30.102	Gas inlet flange	G 1	x	x				
30.30.102-NPT	Gas inlet flange	1 NPT	x	x				
30.30.103	Gas inlet flange	G 1 1/4	x	x				
30.30.103-NPT	Gas inlet flange	1 1/4 NPT	x	x				
30.30.104	Gas inlet flange	G 1 1/2	x	x				
30.30.104-NPT	Gas inlet flange	1 1/2 NPT	x	x				
30.30.106	Gas inlet flange	G 1 1/2			x			
30.30.106-NPT	Gas inlet flange	1 1/2 NPT			x			
30.30.107	Gas inlet flange	G 2			x			
30.30.107-NPT	Gas inlet flange	2 NPT			x			
30.30.108	Gas inlet flange	G 2 1/2			x			
30.30.108-NPT	Gas inlet flange	2 1/2 NPT			x			
30.30.114	Gas inlet flange	G 4				x		
30.30.116	Gas inlet flange	G 5					x	
30.30.118	Gas inlet flange	G 6						x

## 5 Stepper Motor Harness – Standard

P/N	Description	VariFuel2/VariFuel2+ (D= digital)						Equivalent to
		100-60D	140-80D	200-120D	250-150D	300-190D	350-225D	
31.01.942 <b>5A</b>	Stepper motor harness, MIL, 10 pole, socket , 90°, length 10 m (400 in)	x	x	x	x	x	x	
31.01.947-10	Stepper motor harness, MIL, 10 pole, socket , 90°, length 10 m (400 in), with corrugated tube	x	x	x	x	x	x	
31.02.087-10 <b>5B</b>	Stepper motor harness, MIL, 10 pole, socket , 90°, length 10 m (400 in)	x	x	x	x	x	x	31.01.942

## 5 Stepper Motor Harness – Special

P/N	Description	VariFuel2/VariFuel2+ (D= digital)						Equivalent to
		100-60D	140-80D	200-120D	250-150D	300-190D	350-225D	
95.30.942-32 <sup>1)</sup>	Stepper motor harness, MIL, 10 pole, socket , 90°, length 10 m (400 in), with fitting for 1/2 in flex conduit	x	x	x	x	x	x	

<sup>1)</sup> Flex conduit has to be ordered separately or supplied by customer.

## Accessories for Stepper Motor Harness – Special

P/N	Figure	Description
15.07.112	<b>5C</b>	Flex conduit, 1/2 in, black <sup>1)</sup>
15.07.221	<b>5D</b>	Fitting, 1/2 in, junction box to flex conduit
06.05.075		Junction box

<sup>1)</sup> Flex conduit needs to be ordered in m/ft in required length.

## 6 VariStep3 Stepper Motor Driver <sup>1)</sup>

P/N	Supersedes	Description	VariFuel2/VariFuel2+ (D= digital)					
			100-60D	140-80D	200-120D	250-150D	300-190D	350-225D
31.01.960	31.01.955	VariStep3 stepper motor driver	x	x	x	x	x	x

<sup>1)</sup> For multiple mixer applications each VariFuel2 air/gas mixer needs a single VariStep3 stepper motor driver.



# Air/Fuel Ratio Control Systems

## Isolation Amplifier <sup>1)</sup>

P/N	Figure	Description	VariFuel2/VariFuel2+ Series (D= digital)					
			100-60D	140-80D	200-120D	250-150D	300-190D	350-225
63.02.017	1	Isolation amplifier, configurable	x	x	x	x	x	x

<sup>1)</sup> Used to pass on the position signal of an EmCon5 emissions controller to a second VariStep3 stepper motor driver. This way two VariFuel2 air/gas mixers can be controlled with one EmCon5 emission controller on a V-engine.

## System Overview

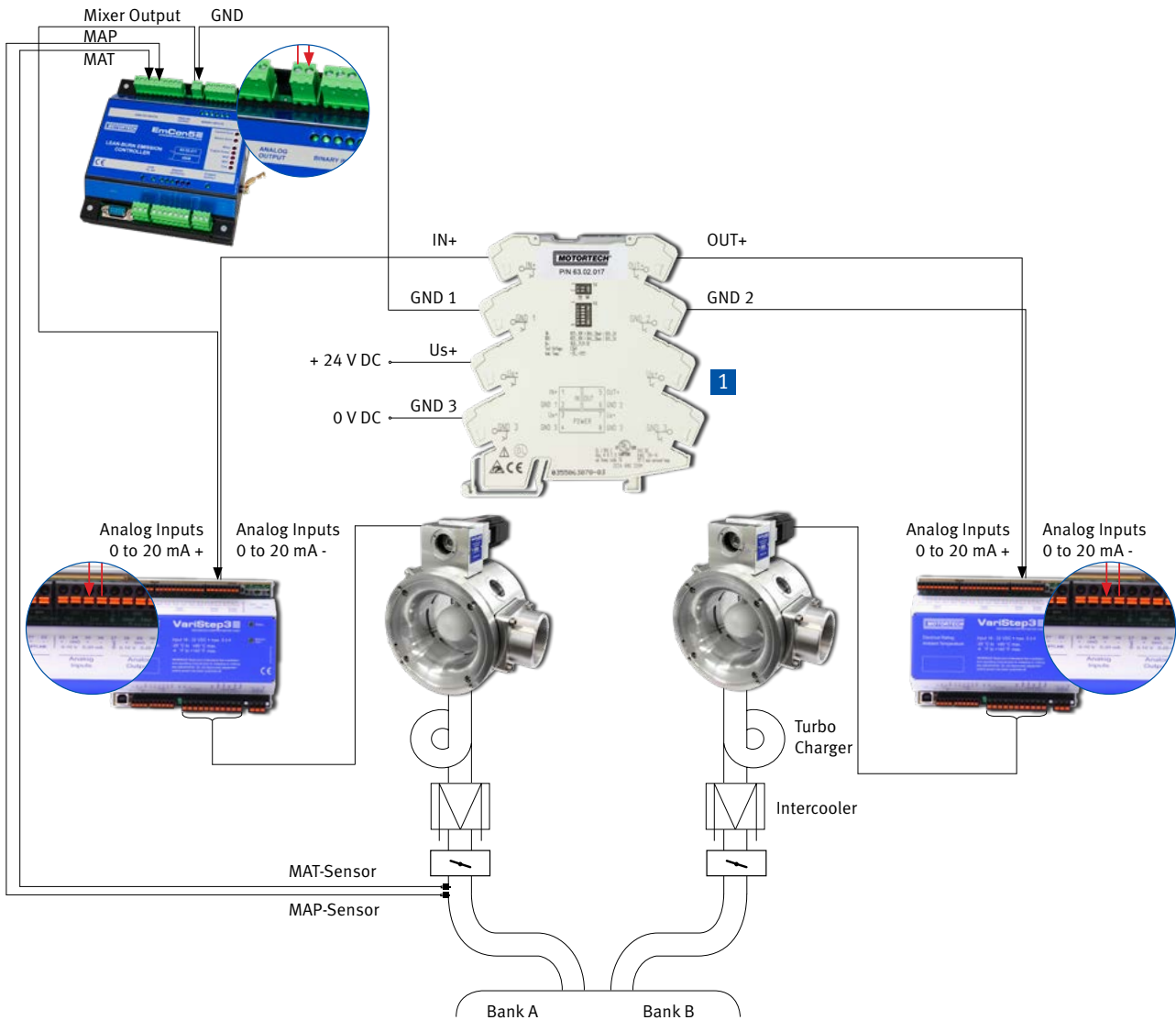

## Test Kit for Commissioning

P/N	Figure	Description	VariFuel2/VariFuel2+ (D= digital / M= manual)					
			100-60D/M	140-80D/M	200-120D/M	250-150D/M	300-190D/M	350-225D/M
01.56.001	1	Test Kit for commissioning, flow bodies for air/gas mixers	x	x	x	x	x	x

## Test and Calibration Box for VariStep Stepper Motor Cards and Stepper Motors

P/N	Figure	Description	VariFuel2/VariFuel2+ Series (D= digital)					
			100-60D	140-80D	200-120D	250-150D	300-190D	350-225D
31.01.965	2	Test and calibration box for VariStep stepper motor cards and stepper motors	x	x	x	x	x	x

## Tools for Repair and Maintenance

P/N	Figure	Description	VariFuel2/VariFuel2+ (D= digital / M= manual)								
			100-50	100-60	140-65	140-80	200-100	200-120	200-150	300-190	350-225
31.01.948-100	3	VariFuel2 adjustment tool for belt tension	x(D/M)	x(D/M)							
31.01.948-140	3	VariFuel2 adjustment tool for belt tension			x(D/M)	x(D/M)					
31.01.948-200	3	VariFuel2 adjustment tool for belt tension					x(D/M)	x(D/M)			
31.01.948-250	3	VariFuel2 adjustment tool for belt tension							x(D/M)		
31.01.948-300	3	VariFuel2 adjustment tool for belt tension								x(D/M)	
31.01.948-350	3	VariFuel2 adjustment tool for belt tension									x(D/M)
31.01.943	4	VariFuel2 locking tool for toothed pulley	x(D/M)	x(D/M)	x(D/M)	x(D/M)	x(D/M)	x(D/M)	x(D/M)	x(D/M)	x(D/M)
31.01.949	5	VariFuel2 tool for inspection window	x(D/M)	x(D/M)	x(D/M)	x(D/M)	x(D/M)	x(D/M)	x(D/M)	x(D/M)	x(D/M)
31.01.959	6	VariFuel2 tool for maintenance cap, for series 100-50 up to S/N 05014433	x(D/M)								





## Air/Fuel Ratio Control Systems

### Repair Kits for VariFuel2/VariFuel2+ Air/Gas Mixers

P/N	Description	VariFuel2/VariFuel2+ Series (D= digital / M= manual)								
		100-50	100-60	140-65	140-80	200-100	200-120	250-150	300-190	350-225
31.01.997-1-100-50A	Basic kit, series 100-50 (from S/N 001 up to 05015052)	x(D/M)								
31.01.997-1-100-50B	Basic kit, series 100-50 (from S/N 05015053)	x(D/M)								
31.01.997-1-100-60	Basic kit, series 100-60		x(D/M)							
31.01.997-1-140-65	Basic kit, series 140-65			x(D/M)						
31.01.997-1-140-80	Basic kit, series 140-80				x(D/M)					
31.01.997-1-200-100A	Basic kit, series 200-100 (from S/N 001 up to 05010012)					x(D/M)				
31.01.997-1-200-100B	Basic kit, series 200-100 (from S/N 05010267)					x(D/M)				
31.01.997-1-200-120A	Basic kit, series 200-120 (from S/N 001 up to 05015009)						x(D/M)			
31.01.997-1-200-120B	Basic kit, series 200-120 (from S/N 05015201)						x(D/M)			
31.01.997-1-250-150	Basic kit, series 250-150							x(D/M)		
31.01.997-1-300-190	Basic kit, series 300-190								x(D/M)	
31.01.997-1-350-225	Basic kit, series 350-225									x(D/M)
31.01.997-2-100-50A	Stepper motor kit, Rev. A, series 100-50 <sup>1)</sup>	x(D)								
31.01.997-2-100-50B	Stepper motor kit, Rev. B, series 100-50	x(D)								
31.01.997-2-A	Stepper motor kit, Rev. A, series 140 to 200 <sup>1)</sup>			x(D)		x(D)	x(D)			
31.01.997-2-B	Stepper motor kit, Rev. B, series 140 to 350		x(D)	x(D)	x(D)	x(D)	x(D)	x(D)	x(D)	x(D)
31.01.997-3-100-60	Outlet nozzle kit, series 100-60		x(D/M)							
31.01.997-3-140-80	Outlet nozzle kit, series 140-80				x(D/M)					
31.01.997-3-200-120B	Inlet nozzle kit, series 200-120 (from S/N 05015201)						x(D/M)			
31.01.997-3-250-150	Inlet nozzle kit, series 250-150							x(D/M)		
31.01.997-3-300-190	Outlet nozzle kit, series 300-190								x(D/M)	
31.01.997-3-350-225	Outlet nozzle kit, series 350-225									x(D/M)
31.01.997-4	Gauge ports kit, series 100 to 350	x(D/M)	x(D/M)	x(D/M)	x(D/M)	x(D/M)	x(D/M)	x(D/M)	x(D/M)	x(D/M)

<sup>1)</sup> Consult factory for availability.

## Gaskets for Outlet Flange Kits <sup>1)</sup>

Gasket		Included in	P/N Outlet Flange Kit
P/N VariFuel-Sided	P/N Engine-Sided		
31.01.365	03.90.050	Outlet flange kit, gas relaxation section for throttle, series 50	31.01.764
31.01.365	03.90.100	Outlet flange kit, gas relaxation section for throttle, series 100	31.01.765
31.01.858	03.90.050	Outlet flange kit, gas relaxation section for throttle, series 50	31.01.766
31.01.858	31.01.365	Outlet flange kit, for MAN® E0834 LE302, E0836 LE202	31.01.768
31.01.809	31.01.876	Outlet flange kit, for MAN® E2876 LE202/212/302	31.01.750
31.01.809		Outlet flange kit, welding neck flange, DN100	31.01.752
31.01.809	31.01.858	Outlet flange kit, for MAN® E0836 LE202	31.01.753
31.01.809	31.01.867	Outlet flange kit, DN65-PN6	31.01.755
31.01.809	31.01.871	Outlet flange kit, for MAN® E2842 E312	31.01.756
31.01.809	03.90.100	Outlet flange kit, for throttle, series 100	31.01.757
31.01.809	03.90.100	Outlet flange kit, gas relaxation section for throttle, series 100	31.01.762
31.01.809	03.90.140	Outlet flange kit, gas relaxation section for throttle, series 140	31.01.763
31.01.809		Outlet flange kit, for LIEBHERR® G934, G944	31.01.773
31.01.809		Outlet flange kit, for LIEBHERR® G946	31.01.781
31.01.876		Outlet flange kit, for MAN® E2676 E302	31.02.113
31.01.879		Outlet flange kit, for MAN® E3262 E302	31.02.115
31.01.879		Outlet flange kit, for MAN® E0836 LE302	31.02.118
31.01.828-1		Outlet flange kit, welding neck flange, DN150	31.01.751
31.01.828-1	31.01.863	Outlet flange kit, for MAN® E2842 LE312	31.01.754
31.01.828-1		Outlet flange kit, hose connection, DN200	31.01.758
31.01.879	31.01.879	Outlet flange kit, for MAN® E2676 LE202/212, E2876 LE202/212/302	31.01.759
31.01.828-1		Outlet flange kit, welding neck flange, DN150 – aluminum	31.01.761
31.01.828-1	31.01.886	Outlet flange kit, for DEUTZ® TCG2015V6/V8	31.01.767
31.01.371, 31.01.828-1	31.01.371, 31.01.372	Outlet flange kit, for SHENG Dong® 600GF1-PS	31.01.772
31.01.828-1		Outlet flange kit, for LIEBHERR® G936	31.01.774
31.01.828-1		Outlet flange kit, for LIEBHERR® G9508	31.01.775
31.01.828-1		Outlet flange kit, for LIEBHERR® G9512	31.01.776
31.01.828-1		Outlet flange kit, for LIEBHERR® G946, DOOSAN® GV158.3013.D	31.01.777
31.01.828-1		Outlet flange kit, for LIEBHERR® G9508	31.01.778
31.01.828-1	31.01.377	Outlet flange kit, linkage for 2 VariFuel2 – series 200-1xx	31.01.779
31.01.828-1	31.01.828-1	Outlet flange kit, for MAN® E2848/42 LE322, E3268 LE2xx, E3262 LE2xx	31.01.780

<sup>1)</sup> Gaskets included in each outlet flange kit.

# Air/Fuel Ratio Control Systems

## VariFuel2-TEM Air/Gas Mixer

For **MWM®** TCG 2016 V08 C, V12 C and V16 C Gas Engines



The VariFuel2-TEM air/gas mixer is based on the proven design of the VariFuel2 series and is specially designed for use with MWM® gas engines. Designed as a replacement and plug-and-play solution for the gas mixers used on the TCG 2016 series, the VariFuel2-TEM easily fits into the existing engine structure without any mechanical modifications.

In addition to full compatibility, both mechanically and in connection with existing TEM controllers, the VariFuel2-TEM contributes to an improvement of the starting behavior and mixture control via its variable fuel ring and enables low-maintenance operation over a long period of time.

### Features

- Plug-and-play solution for easy replacement of the original gas mixer without mechanical modifications or cabling adjustments
  - 1 Suitable flanges for direct connection to existing intake manifold, suction hose and gas train
  - 2 Stepper motor with connecting cable and mating connector to multifunction rail
  - 3 Position sensor suitable for cabling of the multifunction rail
- Direct control by existing TEM management system
- The variable fuel ring of the VariFuel2-TEM improves the mixture control behaviour and thus enables an optimized starting behaviour and performance, especially in operation with special gases
- Low-maintenance part reduces operating costs by saving expensive repair kits



# Air/Fuel Ratio Control Systems



## System Overview

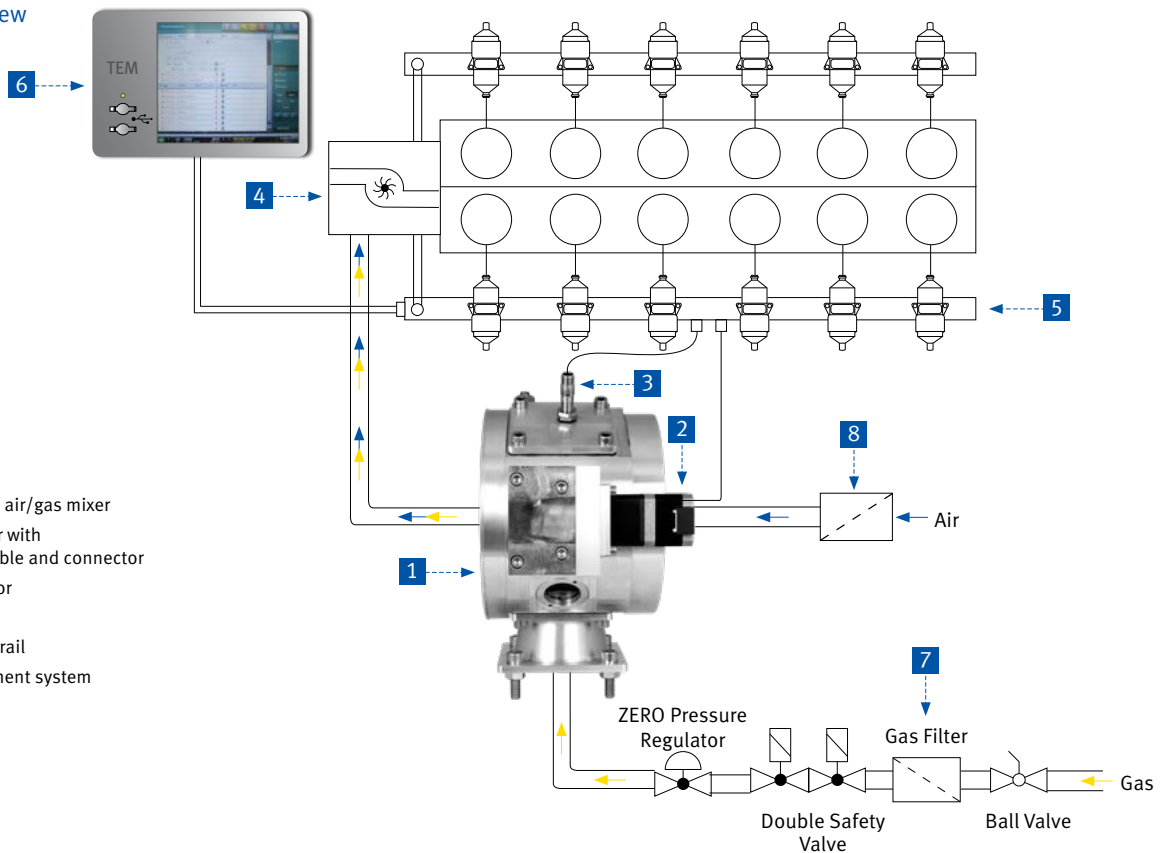

## Description

- 1 VariFuel2-TEM air/gas mixer
- 2 Stepper motor with connecting cable and connector
- 3 Position sensor
- 4 Turbo charger
- 5 Multifunction rail
- 6 TEM management system
- 7 Gastrain
- 8 Air filter

## VariFuel2-TEM Air/Gas Mixer for MWM® TCG 2016 V08 C, V12 C and V16 C Gas Engines

P/N	Supersedes	Description	Equivalent to
30.45.200-120DG-XA		VariFuel2-TEM air/gas mixer for MWM® TCG 2016 V08 C, V12 C and V16 C gas engines	

## VariFuel2 Air/Gas Mixer for MWM® TCG 2016 V08 C, V12 C and V16 C Gas Engines <sup>1)</sup>

P/N	Supersedes	Description	Equivalent to
30.45.200-120D-XA		VariFuel2 air/gas mixer for MWM® TCG 2016 V08 C, V12 C and V16 C gas engines	

<sup>1)</sup> Can be used for conversions of MWM® air/gas mixer only when TEM engine management system is also replaced by ALL-IN-ONE system.

## Flow Bodies for VariFuel2-TEM and VariFuel2 Air/Gas Mixer for MWM® TCG 2016 V08 C, V12 C and V16 C Gas Engines <sup>1)</sup>

P/N	Supersedes	Description	Diameter	Application	Fuel	Equivalent to
31.01.720-85.0-3		Flow body	85.0 mm	MWM® TCG 2016 V08 C	Biogas	
31.01.720-70.0-3		Flow body	70.0 mm	MWM® TCG 2016 V08 C	Natural Gas	
31.01.720-60.0-3		Flow body	60.0 mm	MWM® TCG 2016 V12 C	Biogas	
31.01.720-30.0-3		Flow body	30.0 mm	MWM® TCG 2016 V12 C	Natural Gas	
31.01.720-65.0-3		Flow body	65.0 mm	MWM® TCG 2016 V16 C	Biogas	
31.01.720-50.0-3		Flow body	50.0 mm	MWM® TCG 2016 V16 C	Natural Gas	

<sup>1)</sup> Flow body needs to be ordered separately according to application.



Please note that mentioned flow bodies are specified on basis of available engine data and are for reference only. Please consult the factory or your nearest MOTORTECH sales partner to get the correct flow body specified for your engine application.



Scan the QR code® to download the questionnaire to identify a suitable flow body for your application.

## Air/Fuel Ratio Control Systems

# VariStep3

MOTORTECH STEPPER MOTOR DRIVER

The stepper motor driver developed by MOTORTECH guarantees the ideal control of the various types of MOTORTECH VariFuel2 and VariFuel2+ air/gas mixers and ITB throttle bodies with integrated stepper motor.

### Features

- Precise mixer and throttle adjustment due to microstep operation
- Very fast response times
- Increased power output provides high torque and quick movement even when driving big stepper motors
- Accelerated reference run
- LEDs displaying unit status and activity
- Combination of several units without signal amplifier/splitter
- Integrated CANopen and Modbus RTU interface
- Configuration via MICT software
- Error data logging for improved diagnostic options
- Compact design
- Plug-in terminals
- Easy access to connectors and switches
- Switch board installation on DIN rail



### VariStep3 Stepper Motor Driver for VariFuel2/VariFuel2+ Air/Gas Mixers and ITB Integrated Throttle Bodies

P/N	Supersedes	Description
31.01.960	31.01.955	VariStep3 stepper motor driver

### Technical Data

- 18 to 32 V DC power supply
- -20 °C up to +60 °C (-4 °F up to 140 °F) permitted ambient temperature
- 0 to 20 mA/ 0 to 10V analog input and output, flexible configuration
- 5 digital inputs, 5 to 32 V compatible, DC-isolated
- 6 digital outputs, up to 32 V, 100 mA, DC-isolated

### Interfaces

- CAN Bus 2.0b interface (CANopen protocol)
- RS485 interface (Modbus RTU)
- USB 1.1 interface

### Configuration

- Using the graphic user interface MICT (MOTORTECH Integrated Configuration Tool)
- Manual control via push-button

### Housing

- Protection class IP 20
- Dimensions 160 x 126 x 62 mm (6.3 x 5.0 x 2.4 in)



## EmCon5

MOTORTECH LEAN-BURN EMISSION CONTROLLER

The EmCon5 is a lean-burn emission controller for gas engine co-generation units. It is designed to control the exhaust gas emission levels based on indirect measurements. Simply three input signals are required for the control purpose: manifold inlet pressure and temperature and engine load. A CH<sub>4</sub> input signal is optional. Use of an oxygen sensor is not required.

Following initial measurements of the engine emission levels and successful analysis, the EmCon5 guarantees optimal operation of the gas engine at the predefined emission limits.

All controller parameters are freely programmable. The adjustments and modifications are made via the computer-program "WinScope". The EmCon5 fits perfectly with the VariFuel2 and VariFuel2+ air/gas mixer series.



### Features

- Standardized system available
- Operates without oxygen sensor
- Two gas qualities programmable
- Easy to use
- Available with complete sensor harness (optional)
- Data logging
- Flexible control for reliable operation with biogas



# Air/Fuel Ratio Control Systems

## System Overview

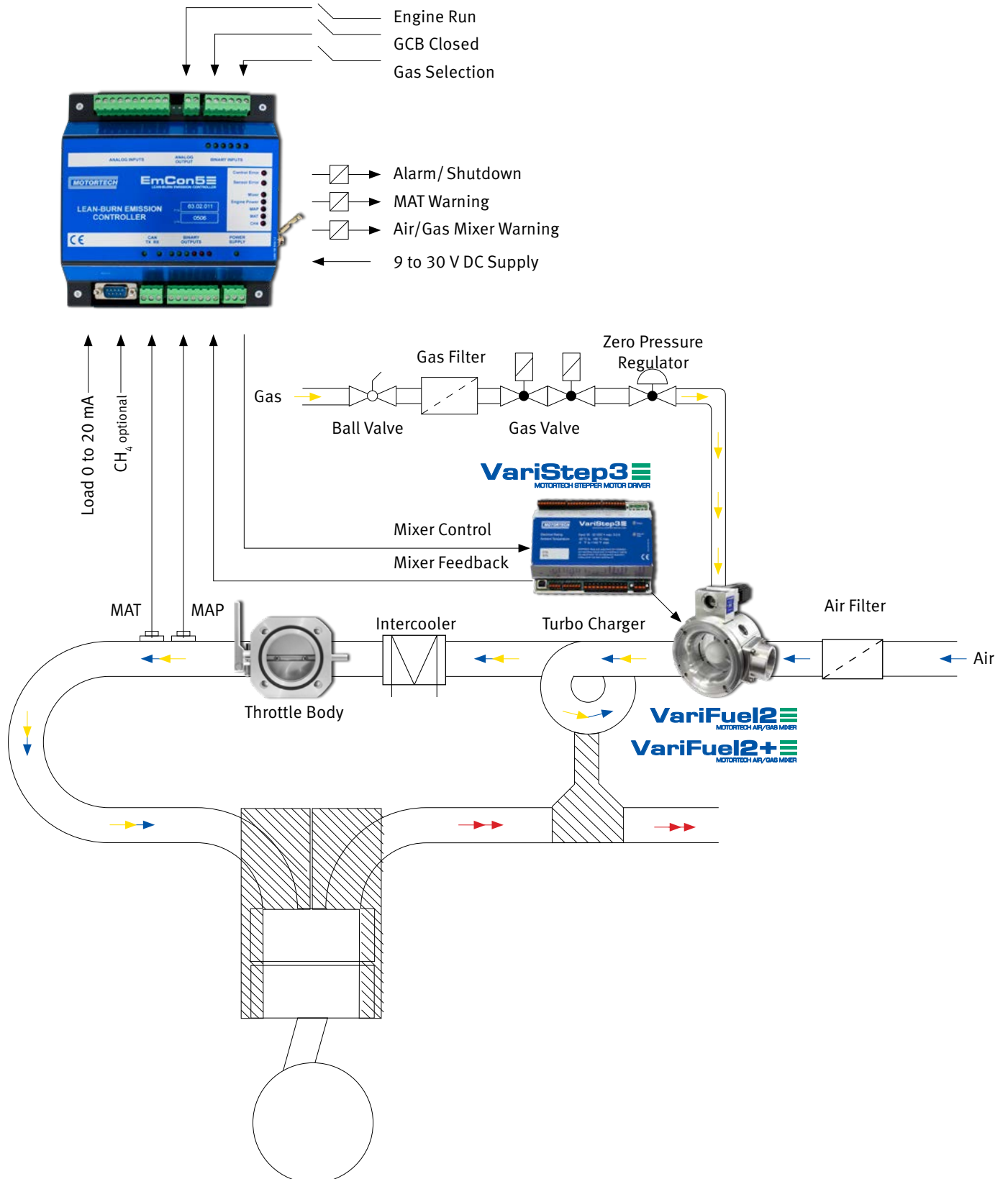

## Control Unit

P/N	Figure	Supersedes	Description	Equivalent to
63.02.011	1		EmCon5 lean burn emission controller	

## Sensor Harness

P/N	Figure	Supersedes	Description	Equivalent to
06.30.045	2		EmCon5 sensor harness, including MAT sensor P/N 56.01.004 and MAP sensor P/N 56.02.017	

## MAT – Manifold Air Temperature Sensors

P/N	Figure	Supersedes	Description	Thread	Fitting Length	Equivalent to
56.01.004	3	56.01.021	MAT sensor	G1/2	2.00 in (50 mm)	
56.01.011	3		MAT sensor	G1/2	3.00 in (75 mm)	
56.01.017	3		MAT sensor	G1/2	4.00 in (100 mm)	

## MAP – Manifold Absolute Pressure Sensor (Industrial Design)

P/N	Figure	Supersedes	Description	Thread	Pressure Range	Equivalent to
56.02.017	4	56.02.016	MAP sensor	G1/4	0 to 3.0 bar	

## Load Transducer

P/N	Figure	Supersedes	Description	Equivalent to
63.02.013	5		Load transducer, 0 to 5 A → 0 to 20 mA/4 to 20 mA/0 to 10 V/2 to 10 V	



1



2



3



4



5

## Exhaust Gas Aftertreatment



### VariSCR NO<sub>x</sub> Emission Controller for SCR Catalysts

MOTORTECH developed the new NO<sub>x</sub> emission controller VariSCR to satisfy the increasing immission protection requirements in the future from the amendment to the emission values in TA-Luft (Technical Instructions on Air Quality Control). In addition to the exhaust gas aftertreatment the VariSCR can also control the air/fuel ratio.

After a transition time up to 2018, NO<sub>x</sub> reduction from a current 500 mg/m<sup>3</sup> to 100 mg/m<sup>3</sup> for natural gas CHP applications (based on a reference oxygen content of 5% by volume) will become obligatory for new and existing CHP plants. To bring about constant reduction of NO<sub>x</sub>-emissions in the SCR (Selective Catalytic Reduction) system, AdBlue<sup>®</sup>, a solution of 32.5% urea in water, will be injected into the exhaust gas flow in front of the SCR catalysts. The urea is converted into ammonia through thermolysis and hydrolysis. In the SCR catalysts, the ammonia then reduces the nitrogen oxides to water and nitrogen.

Besides the algorithms for NO<sub>x</sub> reduction, the software also contains controllers for controlling the pump module to maintain constant delivery pressure and the heating controller for the dosing unit.

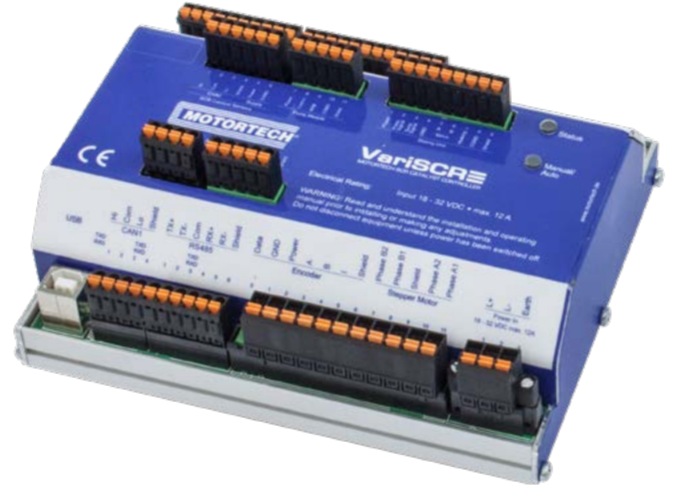

#### Available System Components

- VariSCR NO<sub>x</sub> emission controller
- Sensor harness
- Wiring harness for dosing unit
- Wiring harness for pump module

#### Features

- Read out of the NO<sub>x</sub> sensors in front of and behind the catalysts
- Control of the urea injection to the NO<sub>x</sub> set-point value through monitoring of the raw and target emission after the SCR catalysts
- Control of the urea pump for controlling and monitoring the AdBlue<sup>®</sup> injection quantity, temperature, and the delivery pressure
- Regulation of the AdBlue<sup>®</sup> heating and circulation
- Fault detection and diagnostics
- Connection to master control via CAN-Bus

# Exhaust Gas Aftertreatment



## System Overview

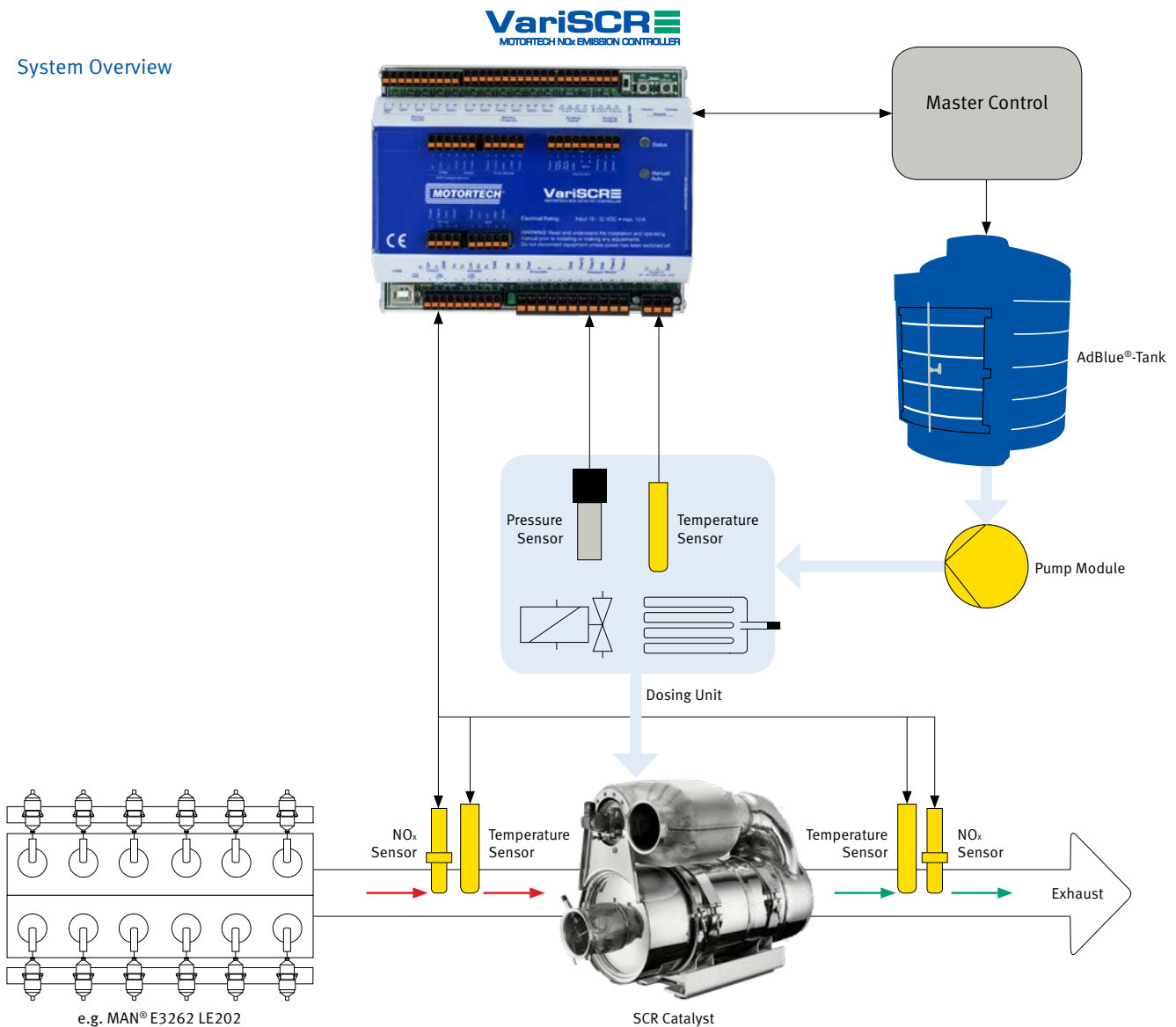

VariSCR NO<sub>x</sub> Emission Controller

### Technical data

- 18 to 32 V DC power supply
- -20 °C to +60 °C (-4 °F up to 140 °F) permitted ambient temperature
- 0 to 20 mA/ 0 to 10 V analog input and output, freely configurable
- 5 digital inputs, 5 to 32 V, compatible, galvanic separation
- 6 digital outputs, up to 32 V, 100 mA, galvanic separation

### Interfaces

- 2 CAN Bus 2.0b interfaces (CANopen protocol)
- RS485 interface (Modbus RTU)
- USB 1.1 interface

### Configuration

- Using the graphical user interface MICT (MOTORTECH Integrated Configuration Tool)

### Housing

- Protection class IP 20
- Dimensions 160 x 126 x 62 mm (6.3 x 5.0 x 2.4 in)

# Exhaust Gas Aftertreatment

## Catalysts

### For Efficient and Reliable Emission Reduction

Increasingly stringent emission regulations require the use of exhaust gas aftertreatment technologies for the operation of stationary gas engines. Exhaust gas catalysts play an important role in reducing harmful emissions and complying with legal limits, thus contributing to the protection of the environment.

MOTORTECH catalysts are always designed and manufactured according to customer and application requirements and guarantee a successful reduction of harmful emissions and compliance with legal limits. With different housing concepts, tailor-made catalysts or elements are created which fit perfectly into a customer plant construction or as a replacement in existing engine sites.



### General Features

- Catalysts are designed and manufactured according to specific customer requirements
- Coatings are calculated and produced for each application's specifications
- Stainless steel modular construction includes nickel alloys or ceramic substrates resistant to high temperatures
- Catalysts can be supplied as complete units, elements with flanges or as replacement elements
- High quality substitute catalyst solutions are available to replace all popular catalyst brands

### Technical Features

- Precise control over critical manufacturing parameters assures optimum performance and longevity
- Formulated to be durable and tolerant of common contaminants
- Coating formulations engineered for long life and strong response to chemical washings
- Each catalyst is individually serial numbered and inspected for 100% traceability



# Exhaust Gas Aftertreatment



## Oxidation Catalyst for CO and VOC Reduction On Lean-Burn Gas Engines

Oxidation catalysts convert carbon monoxide (CO) and volatile organic compounds (VOC's including formaldehyde) from lean-burn reciprocating engines. MOTORTECH oxidation catalysts use only platinum precious metal for high performance, long life, poison resistance, and their ability to be chemically regenerated time after time. Field proven catalyst products are available for 2-stroke and 4-stroke engines, high-propane fuels, low-BTU fuels, refinery gases, biogases and high-sulfur fuels.

## 3-Way (NSCR) Catalyst for NO<sub>x</sub>, CO and VOC Reduction On Rich-Burn Gas Engines

NSCR (non-selective catalytic reduction) catalysts convert nitrogen oxides (NO<sub>x</sub>), carbon monoxide (CO) and volatile organic compounds (VOC's including formaldehyde) from the exhaust of rich-burn gas engines. These engines, fueled by natural gas, wellhead gas, refinery gas and others are used in gas compression and power generation.



Scan the QR code<sup>®</sup> to download the questionnaire to identify a suitable catalyst for your application.

### Catalyst Inquiry Form

#### Contact Data

Company		Contact person
Address		
Phone	Fax	Email

#### Catalyst Sizing

Manufacturer and model		Engine operating principle
Engine power (kW)	Rev	Net exhaust gas mass flow (kg/hr)
Net exhaust gas flow (Nm <sup>3</sup> /h)	Exhaust temperature at catalyst (°C)	Oxygen content in exhaust gas (%)
Sulfur content in exhaust gas (ppm in SO <sub>2</sub> )	COH loading in exhaust gas (kg/Nm <sup>3</sup> )	Max. remaining catalyst outer diameter

#### Raw Emissions

Hazardous substance	Value	Unit

#### Emission Limits

Hazardous substance	Value	Unit

Reference oxygen concentration (%)	Max. allowable pressure drop (bar)
------------------------------------	------------------------------------

#### Sizing of Catalyst Housing

Housing type	Max. housing length (mm)	Passive housing length (mm)
Number of exhaust gas pipes (lines)	Flange specification	Housing with measurement points

Individual Housing Solutions and Acoustical Silencers on Request!

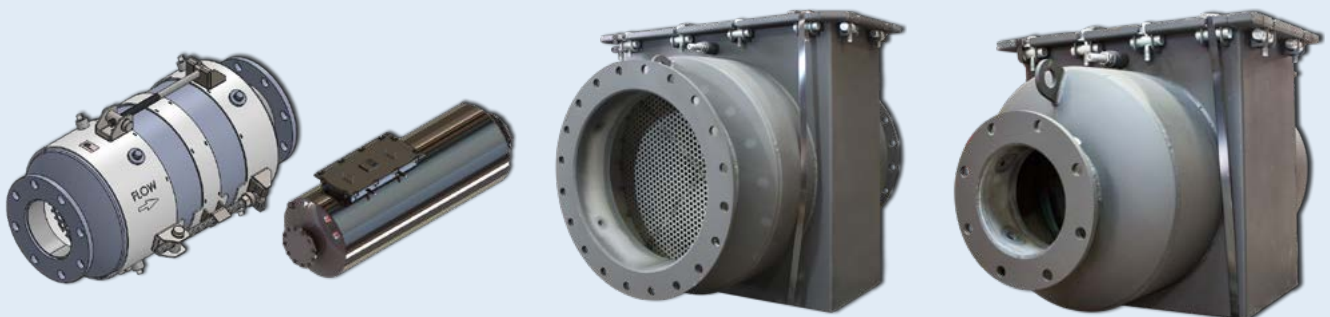



# Exhaust Gas Aftertreatment

## Catalysts for common Applications



## Catalysts for JENBACHER® Gas Engines

P/N	Figure	Description	Application	Cell Density	Shell		Matrix Depth	Equivalent to
					Diameter	Depth		
21.02.504-30089-001E	1	Oxidation catalyst element	J312	300 cpsi	504 mm	100 mm	89 mm	EP-AL 600 (000207)
21.02.520-20213-001E	2	Oxidation catalyst element	J312	300 cpsi	520 mm	213 mm	89 mm	EP-AL 534-AWT (000165), 608158
21.02.520-20089-001E	3	Oxidation catalyst element	J312	200 cpsi	520 mm	133 mm	89 mm	EP-AL 837 (000213), 607401
21.02.518-30089-001E	4	Oxidation catalyst element	J412	300 cpsi	518 mm	100 mm	89 mm	586171
CAT03S44	5	Oxidation catalyst element	J420	200 cpsi	610 mm	133 mm	89 mm	607405



## Catalysts for MWM® Gas Engines

P/N	Figure	Description	Application	Cell Density	Shell		Matrix Depth	Equivalent to
					Diameter	Depth		
CAT03S61	1	Oxidation catalyst element	TCG 2016 V08 C	300 cpsi	300 mm	89 mm	89 mm	EP-AL 300-AWT (000196)
21.01.390-20108-001E	2	Oxidation catalyst element	TCG 2016 V12 C	200 cpsi	390 mm	133 mm	108 mm	EP-AL 400-AWT (000203)
21.01.441-20108-001E	3	Oxidation catalyst element	TCG 2016 V16 B	200 cpsi	441 mm	133 mm	114 mm	EP-AL 450-AWT (000204)

# Exhaust Gas Aftertreatment



## Catalysts for MAN® Gas Engines

P/N	Figure	Description	Application	Cell Density	Shell		Matrix Depth	Equivalent to
					Diameter	Depth		
21.02.254-30089-001E	1	Oxidation catalyst element	E2876, E2848, E2842	300 cpsi	254 mm	100 mm	89 mm	EP-AL 250-AWT (000191)
21.02.310-20089-001E	2	Oxidation catalyst element	E2842	200 cpsi	310 mm	133 mm	89 mm	EP-AL 300-AWT (000196)
HOUA1005	3	Oxidation catalyst with universal flange (DN100 PN6)	universal	300 cpsi	264 mm	300 mm	89 mm	EP-AL 200-DN100 PN6 (000190)
21.02.260-20089-001E	4	Oxidation catalyst element	Agenitor 250 kW	200 cpsi	260 mm	155 mm	89 mm	
21.02.339-20089-001E	5	Oxidation catalyst element	Agenitor 400 kW	200 cpsi	339 mm	160 mm	89 mm	

## Catalysts for MTU® Gas Engines

P/N	Figure	Description	Application	Cell Density	Shell		Matrix Depth	Equivalent to
					Diameter	Depth		
EC-1950-14-S-CS	6	Catalyst housing with flanges (DN350 PN10) and access door for installation of element P/N 21.01.495-30089-001E	12V4000 GS L32FB		518 mm	1140 mm		
21.01.495-30089-001E	6	Oxidation catalyst element, fits into housing P/N EC-1950-14-S-CS	12V4000 GS L32FB	300 cpsi	495 mm	89 mm	89 mm	
EC-2850-20-S-CS	6	Catalyst housing with flanges (DN500 PN10) and access door for installation of element P/N 21.01.724-30089-001E	20V4000 GS L32FB		724 mm	1140 mm		
21.01.724-30089-001E	6	Oxidation catalyst element, fits into housing P/N EC-2850-20-S-CS	20V4000 GS L32FB	300 cpsi	724 mm	89 mm	89 mm	

## Gas Engine Accessories

### Valve Cover Conversion Kit with Flange Safety Device for Spark Plug Leads

A defective or damaged spark plug due to incorrect installation cannot only affect the engine operation. The enormous pressures, especially of the latest engine designs, can be the reason a defective spark plug or parts of it are catapulted out of the cylinder like a bullet. This means danger to life and limb of service or operating staff working in the close engine environment.

The conversion kit designed by MOTORTECH reduces the danger on site. The spark plug lead is fixed with a safety flange directly on the valve cover with its appropriate support. The spark plug well is closed so tightly, that the release of components gets prevented and operational safety is increased.

#### Features

- Kit includes all items for easy conversion
- Valve cover with included flange support, valve cover gasket and O-ring for all MAN® E32 series gas engines
- Safety flanges for fixing the spark plug lead
- The innovative flange design allows easy locking and unlocking of the spark plug lead when service is required
- Specially designed PolyMot™ spark plug leads with embedded groove in the Teflon® insulator to take up the safety flanges
- The spring-loaded secondary terminal guarantees a reliable connection of the spark plug and the spark plug lead
- A variety of PolyMot™ spark plug leads is available to fit different spark plugs and ignition coil types (optional)

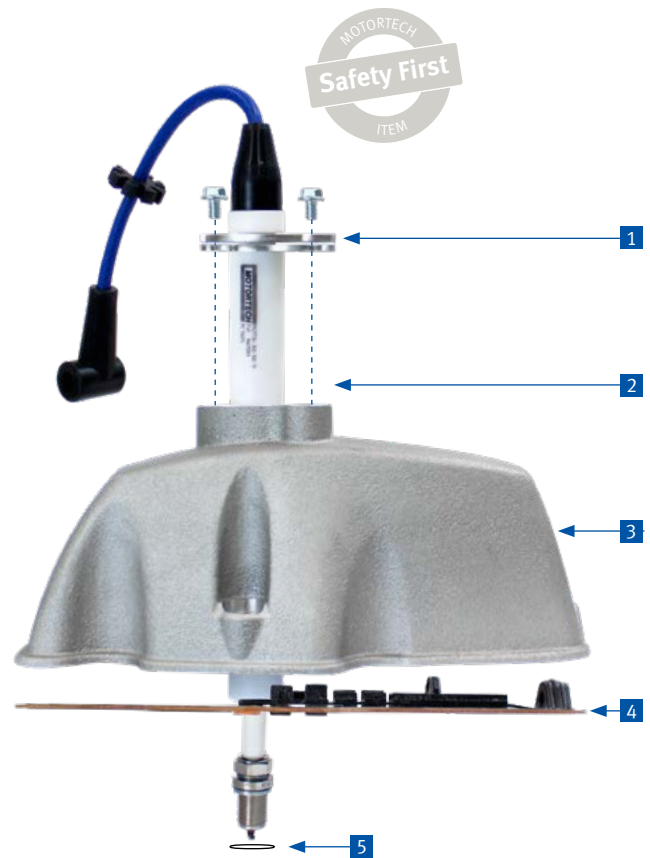

Valve cover with flange support and valve cover gasket



Safety flange kit for spark plug lead

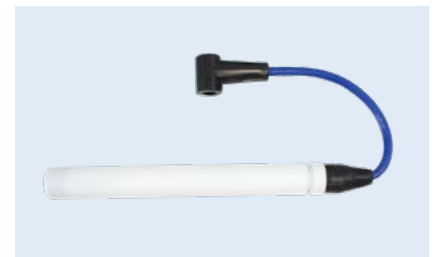

PolyMot™ spark plug lead with embedded groove for safety flanges



The flanges with the locked spark plug lead are fixed on the valve cover with two screws to prevent the release of components from the spark plug well.



To unlock the spark plug lead the two screws just have to be loosened. The safety flanges can now be turned aside on the flange support.



The spark plug lead can then be removed for replacing spark plugs or other service activities.

## Conversion Kit

P/N	Description	Equivalent to	Qty per Cylinder
64.01.055	Valve cover conversion kit for MAN® E32 series gas engines  <i>Contains:</i>		1 pc
	1 Safety flange kit for spark plug lead, incl. 2 flanges	1 pc 51.25441-0913	
	2 Hexagon head screws for fixing the flanges on the valve cover	2 pcs	
	3 Valve cover with flange support	1 pc 51.03401-5109	
	4 Valve cover gasket	1 pc 51.03905-0186	
	5 O-ring for guide tube	1 pc 06.56332-2167	

## PolyMot™ Spark Plug Leads (need to be ordered separately) <sup>1)</sup>

P/N	Description	For Use with		Qty per Cylinder
		Ignition Coil	Spark Plug	
06.85.1073-18	PolyMot™ spark plug lead	06.50.100, 06.50.104, 06.50.112, 06.50.300	DENSO® GE2-3, FM® FN85WWCC, FN86WWCC, 14GZ-LL, 14GZ-LL2	1 pc
06.85.1074-18	PolyMot™ spark plug lead	06.50.100, 06.50.104, 06.50.112, 06.50.300	DENSO® GL3-3/GL3-5, BOSCH® 7308	1 pc
06.85.1078-18	PolyMot™ spark plug lead	06.50.100, 06.50.104, 06.50.112, 06.50.300	DENSO® GE3-1/GE3-5, FM® 14R-4DIU2, BOSCH® 7315	1 pc
06.85.1079-18	PolyMot™ spark plug lead	06.50.100, 06.50.104, 06.50.112, 06.50.300	MOTORTECH B4321	1 pc
06.85.1080-18	PolyMot™ spark plug lead	06.50.100, 06.50.104, 06.50.112, 06.50.300	MOTORTECH B8324, FM® 18GZ5-77-2	1 pc
06.85.1102-18	PolyMot™ spark plug lead	06.50.100, 06.50.104, 06.50.112, 06.50.300	FM® 14R-4DIU3	1 pc
06.85.1106-18	PolyMot™ spark plug lead	06.50.053, 06.50.054, 06.50.055, 06.50.065	DENSO® GE3-1/GE3-5, FM® 14R-4DIU2, BOSCH® 7315	1 pc

<sup>1)</sup> Other spark plug lead versions available on request.

## Accessories

P/N	Description	Equivalent to	Qty per Cylinder
75.10.621	Safety flange kit for spark plug lead, incl. 2 flanges and hexagon head screws for fixing the flanges on the valve cover <sup>1)</sup>	51.25441-0913	1 pc

<sup>1)</sup> Already included in conversion kit P/N 64.01.055.

## Gas Engine Accessories



Combustion engines, compressors, turbines, slide bearings and gears – they all depend on a reliable supply of lubricating oil. For trouble-free operation, each of those systems, dependent on the design, requires a precisely defined oil level that may only be exceeded or undercut by a narrow margin. Moreover, the lubricating capacity of the oil is depleted after a certain operating time – it has to be changed.

Oil level monitoring, oil refill, and even an automated oil change – in other words, the complete management of the oil cycle – can be realized in a completely reliable manner with MOTORTECH's OLC oil level controller.

### Advantages for the User

- Elimination of regular monitoring of the oil level
- Operation is not interrupted for monitoring the oil level
- Operating errors are avoided, no overfilling/lack of oil
- Automated oil change possible
- Less work for staff, increase in operational safety
- Visual surveillance of the oil level during operation is possible
- Remote monitoring from a central location

### Features

- Housing made of a high-grade, saltwater-resistant aluminum alloy
- Individually and infinitely adjustable float switches with reed contacts
- Potential-free closing or opening switches, no voltage transfer
- One-shot switches with step response and unambiguous switching states
- Contacts do not come into contact with oil, protection class IP 65
- Vibration-proof, no interference caused by worn rods/valve seats
- 2, 3 or 4 contacts
- Optional analog level indicator 4 to 20 mA
- Floats resistant to all oils
- Contact protection thanks to integrated resistor
- Switch point adjustment requires the use of tools

- Fail-safe wires
- Suitable for mineral and synthetic oils
- 2 oil and 2 equalization connectors
- Pipe connections with standard inch threads
- Sight glass made of impact-resistant polycarbonate
- Glass sealed with Perbunan (NBR)
- Interior painted white for optimal recognition of oil level
- Slotted holes allow for height adjustment during installation
- Indication of engine wear based on refill frequency
- Indication of water in lubricating oil is possible

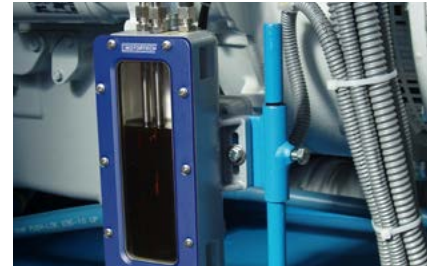

## Product Variants

### Oil Level Controller with Float Switches

The devices of this OLC version are ideal for use with gas engines and they stand out for their reliable monitoring of the oil level.

The housing, made of a saltwater-resistant aluminum alloy, accommodates 2, 3 or 4 float switches. The float switches are screwed into the housing with a clamp screw connection. Any immersion depth can be adjusted with a swivel nut, which makes it possible to set the desired switch point. Subsequent readjustment is also possible without any problems.

A large sight glass made of impact-resistant polycarbonate enables the visual assessment of the current oil level. The white inner coating facilitates viewing even with poor light conditions.

The slotted holes and the optional use of the vertical or horizontal pipe connection threads constitute significant advantages during the installation.

### Float Switch (displayed as MIN Contact)

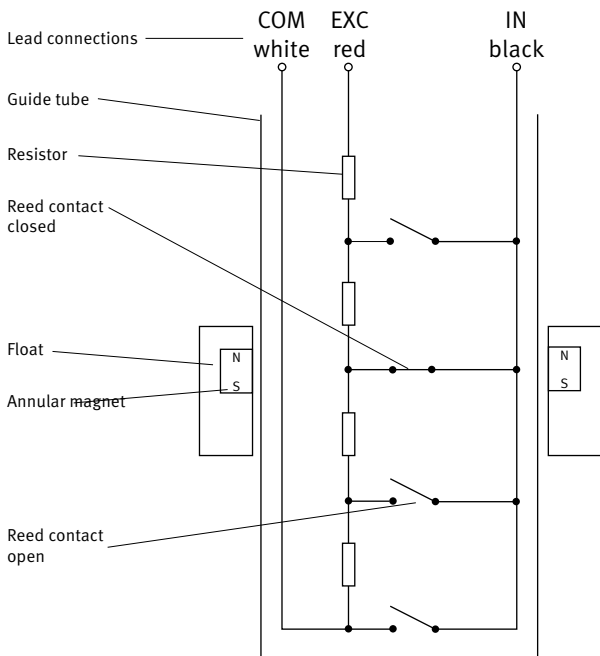
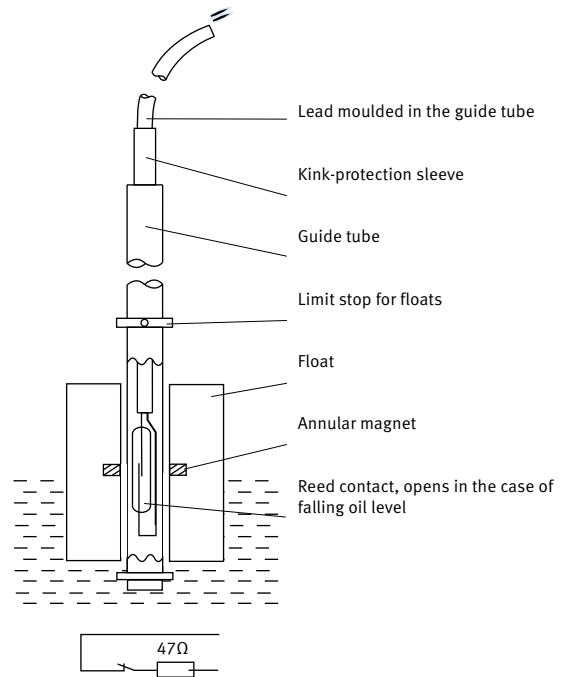

### Oil Level Controller with analog Level Sensor

Unlike an oil level controller with float switches, this OLC version uses reed contacts that are distributed evenly in the guide tube across the entire measuring range of 125 mm. Every reed contact is connected to a resistor. When the float rises or falls with the oil level, the magnetic forces of an annular magnet activate a reed contact through which an electrical current flows. The aforementioned resistors bring about a type of sliding resistance. The variable electrical signal, created by different resistance values, is converted into a standard signal within a range of 4 to 20 mA by a measuring transducer that is connected by cable. This signal can be used in many different ways in a control system (e. g. ALL-IN-ONE). A visual display on a screen or an LED bar graph is also possible.

Two versions of the OLC can be equipped with one or two float switches in addition to the analog sensor in order to provide a redundant monitoring signal for the minimum or maximum oil level.



# Gas Engine Accessories

## Automatic Oil Refill

Monitoring the optimal oil level and signaling a lack of oil or overfilling with the OLC oil level controller is imperative for stationary gas engines that are in continuous operation. Therefore, upgrading to an automatic oil refill is logical and enables operation without supervision.

If the oil level falls short of the switch point for the refill contact (or the set electrical current with an analog sensor), then the engine control system sends a signal to the refill valve or to a refill pump. Fresh oil will be supplied to the engine until the refill contact interrupts the flow of oil.

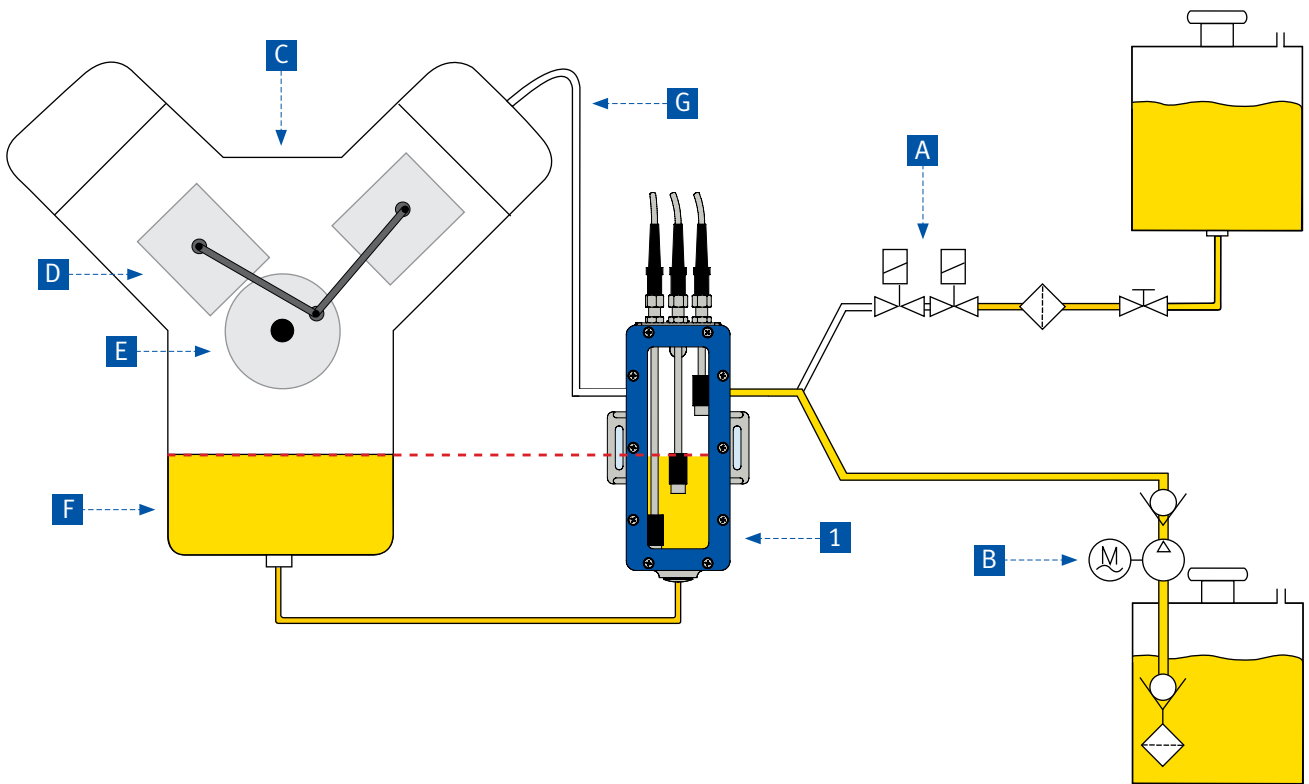

### Required Accessories

- 1 OLC oil level controller

### Accessories

- A Solenoid/double solenoid valve <sup>1)</sup>  
alternative
- B Oil pump <sup>2)</sup>

### Description

- C Engine
- D Piston
- E Crankshaft
- F Oil pan
- G Compensation line

<sup>1)</sup> An oil storage tank positioned above the engine, from which the oil flows by gravity, requires a solenoid valve for blocking, or better yet a double solenoid valve for reasons of redundancy.

<sup>2)</sup> An oil storage tank located below the engine must be equipped with an electric pump.

## 1 Oil Level Controllers with Analog Level Sensor 4 to 20 mA – Transducer in Metal Housing

P/N	Description	Add. Float Switch	Cable Length	Cable Insulation
80.01.214	OLC oil level controller with analog level sensor		4.0 m	PVC
80.01.214-1104	OLC oil level controller with analog level sensor	MIN	4.0 m	PVC
80.01.214-1204	OLC oil level controller with analog level sensor	MAX	4.0 m	PVC
80.01.214-2104	OLC oil level controller with analog level sensor	MIN/MAX	4.0 m	PVC

## 1 Oil Level Controllers with two Float Switches

P/N	Description	Cable Length	Cable Insulation
80.01.210-2001	OLC oil level controller	1.0 m	PVC
80.01.210-2004	OLC oil level controller	4.0 m	PVC

## 1 Oil Level Controllers with three Float Switches

P/N	Description	Cable Length	Cable Insulation
80.01.210-3001	OLC oil level controller	1.0 m	PVC
80.01.210-3004	OLC oil level controller	4.0 m	PVC

## 1 Oil Level Controllers with four Float Switches

P/N	Description	Cable Length	Cable Insulation
80.01.210-4001	OLC oil level controller	1.0 m	PVC
80.01.210-4004	OLC oil level controller	4.0 m	PVC

## A Double Solenoid Valves

P/N	Description	Coil Voltage	Maximum Pressure	Cable Length	Cable Insulation
81.00.310-01	Double solenoid valve, 2/2 way	230 V/50 Hz	24 bar	1.0 m	PVC
81.00.310-04	Double solenoid valve, 2/2 way	230 V/50 Hz	24 bar	4.0 m	PVC
81.00.311-01	Double solenoid valve, 2/2 way	24 V	16 bar	1.0 m	PVC
81.00.311-04	Double solenoid valve, 2/2 way	24 V	16 bar	4.0 m	PVC
81.00.312-01	Double solenoid valve, 2/2 way	12 V	16 bar	1.0 m	PVC
81.00.312-04	Double solenoid valve, 2/2 way	12 V	16 bar	4.0 m	PVC
81.00.313-01	Double solenoid valve, 2/2 way	24 V/50 Hz	24 bar	1.0 m	PVC
81.00.313-04	Double solenoid valve, 2/2 way	24 V/50 Hz	24 bar	4.0 m	PVC

## A Solenoid Valves

P/N	Description	Coil Voltage	Maximum Pressure	Cable Length	Cable Insulation
81.00.300-01	Solenoid valve, 2/2 way	230 V/50 Hz	24 bar	1.0 m	PVC
81.00.300-04	Solenoid valve, 2/2 way	230 V/50 Hz	24 bar	4.0 m	PVC
81.00.301-01	Solenoid valve, 2/2 way	24 V	16 bar	1.0 m	PVC
81.00.301-04	Solenoid valve, 2/2 way	24 V	16 bar	4.0 m	PVC
81.00.302-01	Solenoid valve, 2/2 way	12 V	16 bar	1.0 m	PVC
81.00.302-04	Solenoid valve, 2/2 way	12 V	16 bar	4.0 m	PVC
81.00.303-01	Solenoid valve, 2/2 way	24 V/50 Hz	24 bar	1.0 m	PVC
81.00.303-04	Solenoid valve, 2/2 way	24 V/50 Hz	24 bar	4.0 m	PVC

## B Oil Pumps

P/N	Description	Voltage	Connected Load	Protection class	Max. Pump Capacity	Max Pressure
81.00.510	Oscillating piston pump	230 V/50 Hz	30 W	IP 66	0.4 l/min.	0.7 bar
81.00.511	Oscillating piston pump	230 V/50 Hz	60 W	IP 65	1.5 l/min.	2.5 bar

## Gas Engine Accessories

### Coolant Filtration

#### Stainless Steel Coolant Filters for Stationary Applications

These bypass filters with stainless steel filter elements clean coolant liquids from all deposits. Elements can be washed and do not need to be disposed. Increases water pump life, cylinder head efficiency and equipment availability. Reduces service and maintenance cost.

Coolant should be clean and clear!



#### Features

- Easy to install
- Cleans and maintains coolant system from rust and contaminants
- Increases water pump life
- Reduces coolant deposits and increases cylinder head efficiency and life
- Stainless steel filter elements can be cleaned – NO WASTE
- Visual flow indicator (stationary applications)
- Easy to service – decreases maintenance cost
- Filter micron rating: standard – 50 micron optional – 25 micron
- Flow rate up to 30 GPM

#### Technical Advantage

- Inhibits electro-chemical degradation of engine components. An industrial gas engine has the characteristics of a large battery when coolant is circulated through the engine block. Contaminants and suspended solids in the coolant act as a conductor, which more readily allows current to flow throughout the engine block, which degrades EPDM, buna, rubber, viton, and soft metal or alloy components / water pump bearings, impellers, etc.
- Cleaned coolant inhibits corrosion on engine components such as cylinder heads, cylinder liners and seals, water pump impellers and bearings, etc.
- Prevents “flash-off” in the cylinder heads when engine has an emergency stop; as the coolant can properly dissipate thermal loads
- Inhibits scale deposits on all coolant passages and interior thermal surfaces of the engine block.

Standard – For Temperatures up to 200 °F/95 °C

P/N	Figure	Description	Element Outside Diameter	Element Length	Micron Rating <sup>1)</sup>	Stand	Flow Indicator	Equivalent to
25.00.009-50-30	1	Coolant filter	5.00 in	9.00 in	50 µm	30.00 in	X	489501
25.00.009-50	1	Coolant filter	5.00 in	9.00 in	50 µm		X	
25.00.018-50-49	1	Coolant filter	5.00 in	18.00 in	50 µm	49.00 in	X	489625
25.00.018-50	1	Coolant filter	5.00 in	18.00 in	50 µm		X	

<sup>1)</sup> For 25 micron filter elements please change part number from -50 to -25.

High Temperature – For Temperatures from 200 °F/95 °C up to 400 °F/205 °C

P/N	Figure	Description	Element Outside Diameter	Element Length	Micron Rating <sup>1)</sup>	Stand	Flow Indicator	Equivalent to
25.00.009-50-30-HT	1	Coolant filter	5.00 in	9.00 in	50 µm	30.00 in	X	
25.00.009-50-HT	1	Coolant filter	5.00 in	9.00 in	50 µm		X	
25.00.018-50-49-HT	1	Coolant filter	5.00 in	18.00 in	50 µm	49.00 in	X	
25.00.018-50-HT	1	Coolant filter	5.00 in	18.00 in	50 µm		X	

<sup>1)</sup> For 25 micron filter elements please change part number from -50 to -25.

## Single Filter Elements

P/N	Figure	Description	Element Outside Diameter	Element Length	Micron Rating	Equivalent to
25.00.109-25	2	Coolant filter element	5.00 in	9.00 in	25 µm	
25.00.109-50	2	Coolant filter element	5.00 in	9.00 in	50 µm	489508
25.00.118-25	2	Coolant filter element	5.00 in	18.00 in	25 µm	
25.00.118-50	2	Coolant filter element	5.00 in	18.00 in	50 µm	489626

## Shipping Cases for Filter Elements

P/N	Figure	Description	For Element Length	Equivalent to
25.00.209	3	Shipping case	9.00 in	
25.00.218	3	Shipping case	18.00 in	

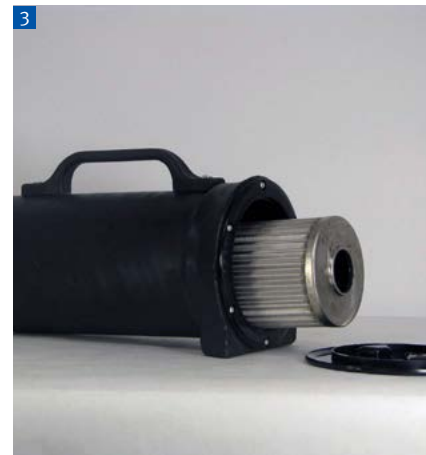

# Gas Engine Accessories



## Lube Oil Filtration

### Stainless Steel Lube Oil Filters

The re-cleanable stainless steel filters for oil filtration are the environmentally friendly alternative to commonly used disposable filters.

Due to re-using of elements, payback starts immediately after installation. Filters are available as replacements for OEM filter elements or custom made to fit your application.

#### Efficiency & Design Benefits

- 100% stainless steel construction
- Increased surface area and flow rates
- Longer fluid life
- High heat tolerances
- High resistance to chemicals and corrosion
- Extended maintenance intervals
- Improves filtration performance
- Absolute rated contaminant removal
- Direct OEM replacements which require no modification

#### Environmental Benefits

- Eliminates disposal costs
- Eliminates disposal liability
- Reduce landfill waste and environmental harm
- Recyclable

#### Economical Benefits

- Reduce inventory needs and costs
- A one-time cost that pays back quickly
- Environmentally friendly



### 100% Stainless Steel Construction

Stainless steel micronic wire cloth available in micron ratings of 3-400 absolute. Welded serial #, ID tag

304 or 316, 20-gauge stainless steel perforated inner/outer tube 3/16 in on 1/4 in centers

High heat resistant adhesive attaches end caps to filter

Seals available in Buna-N, HSN, Teflon® and Viton to suit your application

### Stainless Steel Replacement Elements available for:

#### Engine and Compressor Filters

WAUKESHA®  
WHITE SUPERIOR®  
CATERPILLAR®  
INGERSOLL RAND®  
COOPER BESSEMER®  
AJAX®

HERCULES®  
GARDNER®  
DENVER®  
ATLAS®  
CORPCO®

#### Process and Hydraulic Filters

PECO®  
PALL®  
PEACOCK®  
CUNO®  
FILTERITE®  
NOWATA®  
SCHROEDER®  
POROUS MEDIA®  
FAIREY ARLON®  
UCC®  
STAUFF®

BALDWIN®  
FACET®  
FRAM®  
HILCO®  
REFILCO®  
NUGENT®  
VICKERS®  
GRESEN®  
HYCON®  
PARKER®  
HYTREX®

## Filter Element Kits <sup>1)</sup>

P/N	Description	Element Outside Diameter	Element Length	Micron Rating	Number of included Elements	Application	Equivalent to
25.00.300-1-CA	Lube filter element kit	7.00 in	30.00 in	38 µm	1	CATERPILLAR® G3508/12/16	
25.00.301-6-CA	Lube filter element kit	7.00 in	13.00 in	38 µm	6	CATERPILLAR® G3606/08/12/16	
25.00.303-1-CA	Lube filter element kit	5.00 in	9.00 in	38 µm	1	CATERPILLAR® G3406/08	
25.00.310-4-WA	Lube filter element kit	3.00 in	15.00 in	25 µm	4	WAUKESHA®	167602B
25.00.310-7-WA	Lube filter element kit	3.00 in	15.00 in	25 µm	7	WAUKESHA®	167602B
25.00.310-14-WA	Lube filter element kit	3.00 in	15.00 in	25 µm	14	WAUKESHA®	167602B
25.00.311-4-WA	Lube filter element kit	3.00 in	30.00 in	25 µm	4	WAUKESHA®	168660B, 489493
25.00.311-7-WA	Lube filter element kit	3.00 in	30.00 in	25 µm	7	WAUKESHA®	168660B, 489493
25.00.312-1-WA	Lube filter element kit	5.00 in	7.00 in	75 µm	1	WAUKESHA®	208472B, 489488
25.00.313-1-WA	Lube filter element kit	5.00 in	10.00 in	75 µm	1	WAUKESHA®	208472C, 489489
25.00.314-10-WA	Lube filter element kit	3.00 in	30.00 in	25 µm	10	WAUKESHA®	168660H
25.00.320-3-WS	Lube filter element kit	4.00 in	18.00 in	25 µm	3	WHITE SUPERIOR® 6G/GT/GTL/GTLA-B	
25.00.320-4-WS	Lube filter element kit	4.00 in	18.00 in	25 µm	4	WHITE SUPERIOR® 8G/GT/GTL/GTLA-B/SGTB	
25.00.320-5-WS	Lube filter element kit	4.00 in	18.00 in	25 µm	5	WHITE SUPERIOR® 12G/GT/GTL/GTLA-B/SGT/SGTA-B	
25.00.320-7-WS	Lube filter element kit	4.00 in	18.00 in	25 µm	7	WHITE SUPERIOR® 16G/GT/GTL/GTLA-B/SGT/SGTA-B	
25.00.330-1-AR	Lube filter element kit	4.00 in	9.00 in	38 µm	1	ARIEL®	A-661, A-0661

<sup>1)</sup> All steel lube filter element kits are supplied with a shipping case.

## Single Filter Elements

P/N	Description	Element Outside Diameter	Element Length	Micron Rating	Included in Element Kit	Engine Manufacturer	Equivalent to
25.00.300-CA	Lube filter element	7.00 in	30.00 in	38 µm	25.00.300-1-CA	CATERPILLAR® (Triple Length Element)	
25.00.301-CA	Lube filter element	7.00 in	13.00 in	38 µm	25.00.301-6-CA	CATERPILLAR®	1W-4136
25.00.302-CA	Lube filter element	7.00 in	10.00 in	38 µm		CATERPILLAR®	1R-0726
25.00.303-CA	Lube filter element	5.00 in	9.00 in	38 µm	25.00.303-1-CA	CATERPILLAR®	1R-0716, B99
25.00.310-WA	Lube filter element	3.00 in	15.00 in	25 µm	25.00.310-4-/-7-/-14-WA	WAUKESHA®	167602B
25.00.311-WA	Lube filter element	3.00 in	30.00 in	25 µm	25.00.311-4-/-7-WA	WAUKESHA®	168660B, 489493
25.00.312-WA	Lube filter element	5.00 in	7.00 in	75 µm	25.00.312-1-WA	WAUKESHA®	208472B, 489488
25.00.313-WA	Lube filter element	5.00 in	10.00 in	75 µm	25.00.313-1-WA	WAUKESHA®	208472C, 489489
25.00.314-WA	Lube filter element	3.00 in	30.00 in	25 µm	25.00.314-10-WA	WAUKESHA®	168660H
25.00.315-WA	Lube filter element	5.00 in	17.00 in	25 µm		WAUKESHA®	489491, 305351E
25.00.316-WA	Lube filter element	4.00 in	8.00 in	25 µm		WAUKESHA®	489495, 304126
25.00.317-WA	Lube filter element	5.00 in	12.00 in	25 µm		WAUKESHA®	489490, 305315C
25.00.318-WA	Lube filter element	4.00 in	16.00 in	25 µm		WAUKESHA®	172607, 489522
25.00.320-WS	Lube filter element	4.00 in	18.00 in	25 µm	25.00.320-3-/-4-/-5-/-7-WS	WHITE SUPERIOR®	758-133
25.00.330-AR	Lube filter element	4.00 in	9.00 in	38 µm	25.00.330-1-AR	ARIEL®	A-661, A-0661
25.00.335-EMD	Lube filter element	6.00 in	30.00 in	38 µm		EMD® Locomotive Engines	8345482

## Accessories

P/N	Description	For use with Element/Element Kit	Equivalent to
25.00.222	Pressure gauge, liquid filled		
25.00.226	Grommet seal	25.00.311-WA	
25.00.228	Grommet seal, Viton	25.00.300-CA, 25.00.302-CA	
25.00.229	Seal kit	25.00.330-1-AR	
25.00.231	Grommet seal, Viton	25.00.310-WA, 25.00.311-WA, 25.00.314-WA	



# Gas Engine Accessories

## Ultrasonic Cleaning Equipment

### Ultrasonic Cleaning Station

- 2,000 Watts of ultrasonic cleaning power
- All new, versatile size to meet a variety of parts cleaning needs
- Environmentally safe aqueous cleaning
- Easy-to-operate controls for time, temperature and cleaning cycle automation
- Stainless steel tank construction
- Dual filter system
- Oil removing surface sparger
- Optional on-board task light
- Heavy-duty locking casters
- High velocity ultrasonics, metallurgically attached transducers
- Ultrasonic frequency sweep to enhance cleaning performance



P/N	Description
25.00.001-110 <sup>1)</sup>	<p>Complete ultrasonic cleaning station, 110 V</p> <p><i>Contains:</i></p> <ul style="list-style-type: none"> <li>■ Ultrasonic cleaner</li> <li>■ Soak tank</li> <li>■ Backwash cabinet</li> <li>■ Drying cabinet</li> </ul> <p><i>Included Accesories:</i></p> <ul style="list-style-type: none"> <li>■ 13 Watt high intensity inspection light</li> <li>■ Poly tubing roll</li> <li>■ Bag sealer</li> <li>■ Soak solution, two barrels</li> <li>■ Detergent for ultrasonic, two 20 liter pails</li> <li>■ Syphon pump for transfer of soak solution</li> <li>■ Instruction video on cleaning procedures</li> <li>■ Layout drawing for setting up station</li> <li>■ Cleaning detergent for two years</li> </ul>
25.00.001-220 <sup>1)</sup>	<p>Complete ultrasonic cleaning station, 220 V</p> <p><i>Contains:</i></p> <ul style="list-style-type: none"> <li>■ Ultrasonic cleaner</li> <li>■ Soak tank</li> <li>■ Backwash cabinet</li> <li>■ Drying cabinet</li> </ul> <p><i>Included Accesories:</i></p> <ul style="list-style-type: none"> <li>■ 13 Watt high intensity inspection light</li> <li>■ Poly tubing roll</li> <li>■ Bag sealer</li> <li>■ Soak solution, two barrels</li> <li>■ Detergent for ultrasonic, two 20 liter pails</li> <li>■ Syphon pump for transfer of soak solution</li> <li>■ Cleaning video on cleaning procedures</li> <li>■ Layout drawing for setting up station</li> <li>■ Cleaning detergent for two years</li> </ul>

<sup>1)</sup> Does not include high pressure washer. Customer preference; 2,000 PSI required.

## Gas Engine Accessories



### Subcomponents



#### Soak Tank

- Durable powder coated finish
- Inside tank dimensions 48 x 20 x 16 in
- 1,500 Watt screw in heat element with built in thermostat
- 110 Volt power requirements
- Castor wheels for easy movement of unit
- Hinged lid
- Recirculation pump with 30 minute timer
- Optional heated tank



#### Backwash Cabinet

- Powder coated finish
- Slotted subfloor parts rack
- Water backsplash curtain
- Adjustable parts rack
- Solids sediment waste water tank – 3 stage
- High pressure washer not included



#### Drying Cabinet

- 4,800 Watt – 16,000 BTU heating unit 210 V
- Durable powder coated finish
- Inside cabinet dimensions 48 x 30 x 24 in
- 30 minute timer
- Hinged door with latch closures

Further Ultrasonic Cleaning Models and Accessories are available on request.



#### Ultrasonic Cleaning Station Console Style Unit

- Inside tank dimensions 40 x 12 x 40 in
- Electric heater, thermostatically controlled, 4,000 watts
- Ultrasonics – 40 KHz, 3,000 watts with pulse and sweep
- Transducers mounted on one side wall of tank
- Mechanical timer (1-30 minutes)
- Stainless steel lift cover
- Power requirements 240 V, 50/60 Hz, 8 KVA



#### Ultrasonic Cleaning Station Cabinet Model

- Inside tank dimensions 48 x 16 x 16 in
- 25 KHz
- Variable power controls
- Built-in heater
- “Neptune” generator with pulse and sweep
- All stainless 316L cabinet construction
- Stainless lift off cover
- Heavy duty castors
- Recessed controls
- Recessed tank drain
- Available in 110 or 220 volt
- 2 year warranty on all components



#### Cleaning Vessel

- Filtration of the cleaning fluid to enable maximum cleaning efficiency and extend cleaning solution life
- Pump is 110 V
- Filter unit consists of a stainless steel P2 vessel with a 1/2 HP high-temperature pump, discharge and suction hose

## ■ Technical Support & Service



### Certified Quality

Quality means that the customer returns and not the product. This goal is achieved with a series of automated test procedures and tough endurance tests, which culminate in our zero-defect strategy. Various certifications (e.g. ISO 9001:2015) of the company as well as individual areas according to particularly strict customer and QM requirements for research and development, production, assembly and maintenance confirm the high level of our quality management.



### Subsidiaries and Sales Partners

All MOTORTECH subsidiaries and sales partners are regularly trained by experienced staff so that we can keep our comprehensive quality promise to our most distant customers. MOTORTECH does not simply satisfy industry standards and requirements – we exceed them!



### Consulting

MOTORTECH's customer-focused know-how provides support and consultation for your new developments, project planning, and problem analyses. Moreover, we are ready to assist you with advice and service at any time. Just give us a call! You can be sure that our team will find an optimal solution for your particular problem area.



### Warehousing

In order to guarantee you the best possible delivery to any place in the world, MOTORTECH maintains an extensive stock of parts and finished products. Optimized order processing and selected global logistics partners deliver even the smallest parts directly to where they are needed.

# Technical Support & Service



## Demo Cases

As a sales aid MOTORTECH offers several demo cases that allow the travelling staff to demonstrate and show latest MOTORTECH products to their customers. These demonstration devices and cases will support the sales staff in doing a professional product demonstration.

### Features

- MIC4 demo case for functional simulation of MIC ignition controllers and visualization via PowerView3 HMI module. Includes one channel ignition output to drive a standalone spark gap.
- DetCon20 demo case for functional simulation of DetCon detonation control system. Can be connected to MIC4 demo case to demonstrate the interaction between ignition and detonation control and the visualization of DetCon data via PowerView3 HMI Module.
- Demo cases with ignition parts for CATERPILLAR® and WAUKESHA® gas engines including a selection of common ignition coils, spark plugs, different kind of leads and cutaway models of spark plug leads, harnesses, AlphaRail wiring rails, etc.



P/N	Figure	Description
01.16.002	1	MIC4 demo case incl. ignition controller, PowerView3 HMI module and IPS pickup simulator
01.16.003	2	Spark gap for connection to MIC4 demo case
01.36.001	3	DetCon20 demo case incl. detonation controller and detonation simulator unit
06.05.911	4	Demo case with common ignition parts for WAUKESHA® gas engines
06.05.912	5	Demo case with common ignition parts for CATERPILLAR® gas engines



3



4



5



# Technical Support & Service

## Technical Training at MOTORTECH – the key to your success!

Qualified personnel are the prerequisite for seamless and efficient operation of your equipment and engine. To a large extent they define the level of availability, reliability and lifespan of your systems. The newly built training center at our headquarters in Celle is designed to teach specialists the professional handling of MOTORTECH products. All trainings are based on a hands-on approach and have practical relevance.

MOTORTECH's current seminars offer know-how and realistic solutions for today's challenges for professionals in the gas engine industry. *Pragmatic – prompt – competent!*

The training system is structured modular. The particular modules complement each other and deal with the topic on a whole altogether. Trainings can also be offered on an individual basis in order to cover specific learning needs.



Status options after final test:  
*Gold, Silver or Bronze*

- **Module 1:** Introduction into gas engine technologies, Introduction to the MOTORTECH product world
- **Module 2:** MIC ignition controllers with MOST technology, DetCon detonation control
- **Module 3:** VariFuel2 air/gas mixer, EmCon5 emission control, speed control with ITB throttle body series
- **Module 4:** ALL-IN-ONE Generator & CHP Control System – Beginners course
- **Module 5:** ALL-IN-ONE Generator & CHP Control System – Basics course
- **Module 6:** ALL-IN-ONE Generator & CHP Control System – Advanced users
- **Modul 7:** Status Training (final exam for certification)

More details about our training, participation conditions and all necessary registration forms are available for download at: [www.motortech.de](http://www.motortech.de). The MOTORTECH training team is happy to be at your disposal for every special question you might have.

## Service Team

Take advantage of MOTORTECH's many years of technical expertise in maintenance, repair and service. Our team participates in an ongoing training program and is familiar with the technical and maintenance procedures of all commonly used systems. Our technicians will perform know-how repairs using the latest test instruments and tools, either at your company site or at our own workshops, even on products that we did not produce. Furthermore, to assure you with the best possible delivery anywhere in the world, MOTORTECH maintains an extensive inventory of parts and finished goods.

## Always at Your Site

Regardless of which part of the globe we need to travel to, we know that the stakes are high, and therefore we also outperform the others. That is because we want everything to run smoothly at your site, everywhere and at anytime. This is entirely in keeping with our motto: Let us drop everything and work on your problem!



*“There is hardly any place we would not be able to support your needs and back up our products with service”*

## MOTORTECH Flat Rate Repair and Overhaul Service for Ignition Controllers and VariFuel2 Air/Gas Mixers

### *Quality without Compromise*

Take advantage of our comprehensive flat rate overhaul services. These options offer you knowing in advance what the cost will be. Our intensive repair, overhaul and test procedures allow a full year of warranty on all ignition controllers and VariFuel2 air/gas mixers remanufactured by MOTORTECH.

Our economically remanufacturing processes cover intensive inspections, parts replacements, extensive reconditioning and full operational test procedures. Within an average of four weeks (depends on customer location) we return a fully functional product that looks as good as new.



### Repair and Overhaul Service for Ignition Controllers

Ignition controllers are subjected to extreme loads and must fulfill a wide range of technical requirements under very tough conditions. Parts that are constantly under stress will wear out and tend to fail. Based on years of technical experience MOTORTECH offers a repair and overhaul service for almost all popular ignition controllers in the field.



### Complete Repair and Overhaul of:

- ALTRONIC® D.I.S. series <sup>1)</sup>
- ALTRONIC® DISN series
- ALTRONIC® CPU95 series
- CATERPILLAR® ignition controllers for G3300 & G3400 series gas engines
- All FAIRBANKS MORSE® ignition controllers <sup>1)</sup>
- All MOTORTECH ignition controllers
- WAUKESHA® CEC series
- WAUKESHA® IPM-Diagnostic
- All WOODWARD® ignition controllers

<sup>1)</sup> Please note that due to difficulties in obtaining spare parts for mentioned ignition controllers, we reserve the right to refuse repairs if sent in units are in a condition that is too poor for repair or overhaul. No warranty can generally be assumed for repairs of these ignition controllers carried out by MOTORTECH.

### Repair and Overhaul Service for VariFuel2 Air/Gas Mixers

MOTORTECH also offers a flat rate program for the repair and overhaul of the VariFuel2 air/gas mixers. Sent gas mixers are completely dismantled during the revision process and all components are thoroughly cleaned and tested. During subsequent assembly, defective or worn components are replaced. A final function test and a leakage test guarantee further faultless operation for a long time. As part of plant maintenance, this service is also available for functioning gas mixers to ensure continued operation.



### Complete Repair and Overhaul of VariFuel2/VariFuel2+ Air/Gas Mixers:

- Series 100-50
- Series 100-60
- Series 140-65
- Series 140-80
- Series 200-100
- Series 200-120
- Series 250-150
- Series 300-190
- Series 350-225



## A-Z

Topic	Page	Topic	Page
<b>A</b>			
Accessories for Unshielded Ignition Coils.....	40 – 41	Ignition Coil Tester.....	122
Accessories for Unshielded Spark Plug Leads.....	88 – 91	Ignition Coils for CATERPILLAR® Gas Engines .....	34 – 35
Actuator Replacement Kit .....	196	Ignition Coils – ALTRONIC® Style .....	33, 94, 96, ..... 145, 147
Air/Gas Mixers (VariFuel2) .....	212, 221	Ignition Coils – Externally Mounted.....	48 – 49
Air/Gas Mixers for MWM® Gas Engines (VariFuel2-TEM) ...	221	Ignition Coils – Flange Design.....	42 – 45
<b>C</b>			
Catalysts.....	228 – 231	Ignition Coils – Integral Design .....	50 – 52
Consulting .....	244	Ignition Coils – MOTORTECH Style .....	33, 93, 95
<b>D</b>			
Detonation Control System – DetCon.....	10, 22, ..... 156 – 159, 166, 245	Ignition Coils – New MOTORTECH Style.....	32
Detonation Control Visualization (PowerView3) .....	161	Ignition Control Visualization (PowerView3) .....	26
<b>E</b>			
Emission Controller for SCR Catalysts (VariSCR) ....	226 – 227	Ignition Controllers – MIC3+ Series .....	6 – 7, 12, ..... 115 – 119
Emission Control System – EmCon5 .....	223 – 225	Ignition Controllers – MIC3+CATDI.....	14, 123
Ignition Coil Extension Overhaul Kits.....	39, 101	Ignition Controllers – MIC3+CEC.....	14
Ignition Coil Extensions .....	38, 100	Ignition Controllers – MIC4 Series .....	6, 7, 15, 17, ..... 115 – 119, 123 – 124
Extensions for Integral Ignition Coils .....	103	Ignition Controllers – MIC4-ZS .....	18
Extensions for Shielded Spark Plugs .....	103	Ignition Controllers – MIC5 Series .....	6 – 7, 19, 124
<b>F</b>			
Filtration – Coolant .....	238 – 239	Ignition Controllers – MIC6 Series .....	6 – 7, ..... 21 – 25, 124
Filtration – Lube Oil.....	240 – 241	Ignition Kits for Unshielded Applications .....	116 – 119
<b>G</b>			
Generator & CHP Control System – ALL-IN-ONE .....	190 – 195	Ignition System for Single Cylinder Gas Engines (MOT601).....	28 – 29
<b>H</b>			
Hardware Kit for WAUKESHA® VHP-GL Engines .....	46 – 47	Ignition Wiring Rail Upgrade Kits.....	110 – 115
Harnesses for Competition Ignition Control Systems .....	30 – 31	<b>M</b>	
High Voltage Clamp (SparkScan1).....	121	MOTORTECH Integrated Configuration Tool (MICT) .....	9
High Voltage Indicator (SparkView) .....	44, 46 – 47, ..... 49, 120	MOTORTECH Output Stage Technology (MOST) .....	8, 32
<b>I</b>			
Ignition Coil Conversion Kits .....	36 – 37	<b>O</b>	
Ignition Coil for WÄRTSILÄ® Gas Engines.....	36	Oil Level Control System (OLC) .....	234 – 237
<b>P</b>			
		Pickup Leads.....	57
		Pickup Simulator (IPS).....	123
		Pickups.....	54 – 55
		Pickups for Special Applications .....	56 – 57
		Primary Leads .....	66 – 71

Topic	Page
Primary Leads for MOTORTECH AlphaRail Wiring Rails .....	70
Primary Leads for Special Applications.....	69
Protractor, Digital .....	126
<b>R</b>	
Reluctor Pins.....	60
Repair Kits for Shielded Spark Plug Lead Terminals.....	97
<b>S</b>	
Scope Meter, Digital .....	121
Sensor Harnesses .....	205 – 207
Sensors .....	202 – 205
Sensors – Manifold Absolute Pressure (MAP) .....	223 – 225
Sensors – Manifold Air Temperature (MAT) .....	204, ..... 223 – 225
Service Team.....	246
Spark Plug Accessories.....	154
Spark Plug Cleaning Kit .....	148
Spark Plug Extensions – PolyMot™.....	46, 98 – 99
Spark Plug Leads (Non PolyMot™ Style) .....	84
Spark Plug Leads for CATERPILLAR® Gas Engines .....	81
Spark Plug Leads – PolyMot™ .....	18, 72 – 79, 99, ..... 115 – 119, 232 – 233
Spark Plug Leads – Shielded – Conventional.....	92, 95, ..... 97
Spark Plug Leads – Shielded – MOT-Blues .....	92 – 93
Spark Plug Tools.....	148
Spark Plugs with extended Barrels (XT-Plugs) .....	142 – 143
Spark Plugs with extended Barrels (XTL-Plugs) .....	144 – 147
Spark Plugs – Bridge Design (MBP1800).....	138
Spark Plugs – Pre-Chamber Design (MPC1900) .....	139
Spark Plugs – DENSO® .....	130 – 134, 233
Spark Plugs for Integral Ignition Coils (ICP-Plugs) .....	..... 140 – 141
Spark Plugs – MHP-Plugs.....	136 – 137
Stepper Motor Driver (VariStep3) .....	222

Topic	Page
<b>T</b>	
Technical Training .....	246 – 247
Temperature Module Visualization (PowerView3) .....	161
Temperature Module with 20 Channels (TempScan20)...	166
Test Adaptor for Ignition Controllers .....	124
Thermocouple Rails.....	198 – 199
Thermocouples .....	200 – 201
Throttle Bodies .....	174
Throttle Bodies for MAN® Gas Engines .....	184 – 185
Throttle Bodies for WAUKESHA® Gas Engines.....	186 – 189
Throttle Bodies with Integrated Stepper Motor (ITB).....	178
Timing Light – Conventional Style .....	126
Timing Light (ScopeLite) .....	125
Tools & Accessories for Triggering .....	64
Trigger Discs .....	58 – 59
Trigger Drives .....	60 – 61
Trigger Magnets .....	60
<b>U</b>	
Ultrasonic Cleaning Equipment.....	242 – 243
Unshielded Safety Leads for Shielded Spark Plugs .....	85 – 86
<b>V</b>	
Valve Cover Conversion Kit.....	117, 232 – 233
<b>W</b>	
Wiring Rail Kits for CATERPILLAR® Gas Engines.....	110 – 112
Wiring Rail System for Detonation Control (AlphaRail)....	162
Wiring Rail System for Ignition Control (AlphaRail) .....	104
Wiring Rail System for Temperature Control (AlphaRail)..	168
Workshop Equipment.....	126

## Download now!



### All Products at a Glance!

This document is also available as a digital version. Scan QR code<sup>®</sup> and download the pdf file.



Scan QR code<sup>®</sup>  
to download



Scan QR code<sup>®</sup>  
to subscribe



### MOTORTECH Newsletter!

Always up-to-date to the latest news:

#### Subscribe now!

Subscription also at  
[www.motortech.de/subscribe.html](http://www.motortech.de/subscribe.html)  
or send a short request via email:  
[direkt@motortech.de](mailto:direkt@motortech.de)

#### MOTORTECH GmbH

Hogrevestr. 21-23  
29223 Celle  
Germany  
Phone: +49 (5141) 93 99 0  
Fax: +49 (5141) 93 99 99  
[www.motortech.de](http://www.motortech.de)  
[sales@motortech.de](mailto:sales@motortech.de)

#### MOTORTECH Americas, LLC

1400 Dealers Avenue, Suite A  
New Orleans, LA 70123  
USA  
Phone: +1 (504) 355 4212  
Fax: +1 (504) 355 4217  
[www.motortechamericas.com](http://www.motortechamericas.com)  
[info@motortechamericas.com](mailto:info@motortechamericas.com)

#### MOTORTECH Shanghai Co. Ltd.

Room 1018 Enterprise Square,  
No. 228 Meiyuan Road,  
Zhabei District, 200070 Shanghai  
China  
Phone: +86 (21) 6380 7338  
[www.motortechshanghai.com](http://www.motortechshanghai.com)  
[info@motortechshanghai.com](mailto:info@motortechshanghai.com)

P/N 01.00.001-EN | Rev. 09/2019 | MOTORTECH Product Guide

#### Copyright

The copyright for all materials used in this MOTORTECH publication is reserved. Any kind of duplication or use of objects such as pictures or texts in other electronic or printed publications without approval by MOTORTECH is not permitted.

#### Trademark Information

MOTORTECH products and the MOTORTECH logo are registered and/or common law trademarks of MOTORTECH GmbH.

All OEM names and part numbers shown are for reference purposes only. All trademarks, logos and symbols used or shown in this MOTORTECH publication are exclusive objects to the right of their owners and are used for reference purposes only.

Distribution: